



BUILDBLOCK BUILDING SYSTEMS
GLOBALBLOCK INSTALLATION, TECHNICAL AND
ENGINEERING MANUAL
REVISED 2015



NOTICE: This manual is a supplement to the BuildBlock Installation Manual and covers particular aspects of a GlobalBlock installation which differ from a standard ICF installation. Anything not covered in this manual is superseded by the BuildBlock Installation Manual, the Prescriptive Method, Local or International Codes, or Project Specific Engineering.

GLOBALBLOCK INSTALLATION, TECHNICAL, AND ENGINEERING MANUAL

Table of Contents

GLOBALBLOCK ALL FOAM ICF.....	1
GlobalBlock Forms	2
GlobalBlock Accessories	4
About GlobalBlock	5
<i>Product Description</i>	5
<i>Features and Benefits</i>	5
<i>Uses and Applications</i>	5
<i>Integration with BuildBlock and BuildLock</i>	5
<i>Securing the Base</i>	6
<i>Intersecting Blocks and T-Walls</i>	8
Reinforcement	10
<i>A Note About Rebar</i>	10
<i>Setting Rebar</i>	10
<i>Rebar Saddles</i>	10
<i>Rebar Cross-Pins</i>	10
<i>Plastic Webs</i>	11
<i>Cutting Block</i>	11
<i>Use of End Caps</i>	12
<i>GlobalBlock Angles</i>	12
<i>Penetrations</i>	13
<i>Window and Door Openings</i>	14
<i>Lintels</i>	14
Bracing.....	15
<i>SIP Screws</i>	15
Concrete Design	16
<i>About Concrete Mixes</i>	16
<i>Typical 3000 PSI 3/8" Chip Mix Design</i>	16
Pouring.....	16
<i>Concrete Slump</i>	16
<i>Concrete Consolidation</i>	17
<i>Pouring Notes</i>	17
Concrete Delivery Systems.....	18
<i>Boom Pumps</i>	18
<i>Hose Type</i>	18
<i>Trailer Pumps</i>	18
<i>Truck Chute</i>	18
<i>Bucket System</i>	18
<i>Conveyor delivery</i>	18
Completing Your GlobalBlock Project	19
<i>Finishing</i>	19

GLOBALBLOCK INSTALLATION, TECHNICAL, AND ENGINEERING MANUAL

<i>Waterproofing</i>	19
<i>Expanded Polystyrene (EPS) and UV</i>	19
<i>Backfilling</i>	20
GLOBALBLOCK PRODUCT CAD DETAILS	21
60A GlobalBlock All Foam ICF 3" Straight Block	21
60B GlobalBlock All Foam ICF 3" 90° Corner Block	22
60C GlobalBlock All Foam ICF 4" Straight Block	23
60D GlobalBlock All Foam ICF 4" 90° Corner Block	24
60E GlobalBlock All Foam ICF 6" Straight Block	25
60F GlobalBlock All Foam ICF 6" 90° Corner Block	26
60G GlobalBlock All Foam ICF 8" Straight Block	27
60H GlobalBlock All Foam ICF 8" 90° Corner Block	28
60I GlobalBlock Web Inserts Detail	29
60J GlobalBlock Rebar Saddle Detail	30
60K GlobalBlock Combined Reinforcement Options	31
60L GlobalBlock Using Plastic Web Inserts	32
60M GlobalBlock Using Rebar Pins	33
60N GlobalBlock Using Rebar Saddles	34
GlobalBlock 300 High Wind Load Reinforcement Requirements 1 Story Structure	36
GlobalBlock 400 High Wind Load Reinforcement Requirements 1 Story Structure	37
GlobalBlock 400 High Wind Load Reinforcement Requirements 2 Story Structure	38
GlobalBlock 600 High Wind Load Reinforcement Requirements 2 Story Structure	39
GlobalBlock 800 High Wind Load Reinforcement Requirements 2 Story Structure	40
6" GlobalBlock Screen Grid Form 8-Foot High Basement Wall Vertical Rebar Requirements	41
6" GlobalBlock Screen Grid Form 9-Foot High Basement Wall Vertical Rebar Requirements	42
6" GlobalBlock Screen Grid Form 10-Foot High Basement Wall Vertical Rebar Requirements	43
8" GlobalBlock Screen Grid Form 8-Foot High Basement Wall Vertical Rebar Requirements	44
8" GlobalBlock Screen Grid Form 9-Foot High Basement Wall Vertical Rebar Requirements	45
8" GlobalBlock Screen Grid Form 10-Foot High Basement Wall Vertical Rebar Requirements	46
Maximum Allowable Clear Spans for Screen Grid ICF Lintels in Load-Bearing Walls	47
Maximum Allowable Clear Spans for Screen Grid ICF Lintels in Load-Bearing Walls	48
Maximum Allowable Clear Spans for Screen Grid ICF Lintels in Load-Bearing Walls	49
Maximum Allowable Clear Spans for 6-inch Thick Screen-Grid Lintels in Load-Bearing Walls 1,2,3,4,5,6,16 Roof Clear Span 32 feet and Floor Clear Span 24 feet	50
Maximum Allowable Clear Spans for 6-inch Thick Screen-Grid Lintels in Load-Bearing Walls 1,2,3,4,5,6,16 Roof Clear Span 40 feet and Floor Clear Span 32 feet	51

GLOBALBLOCK INSTALLATION, TECHNICAL AND ENGINEERING MANUAL

Interlocking Nubs

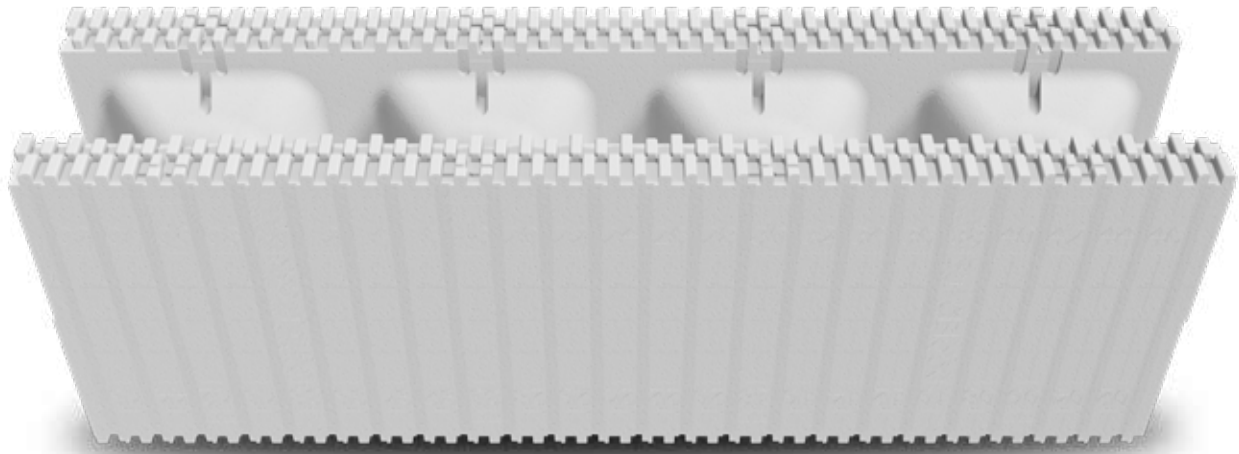

12" ON CENTER

Fully reversible interlock compatible with all BuildBlock forms.

Dedicated 90° corners

16" BLOCK HEIGHT

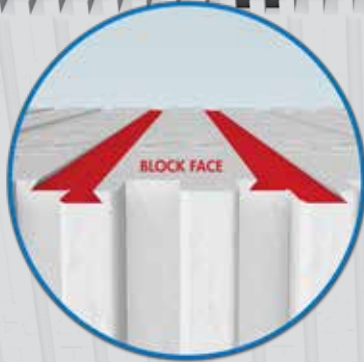

Dovetail block face for EIFS or Stucco application.

2.5" EPS foam on both sides

Three rebar placement and finish attachment options.

GLOBALBLOCK INSTALLATION, TECHNICAL AND ENGINEERING MANUAL

GLOBALBLOCK FORMS



GLOBALBLOCK USING STRAIGHT FORM

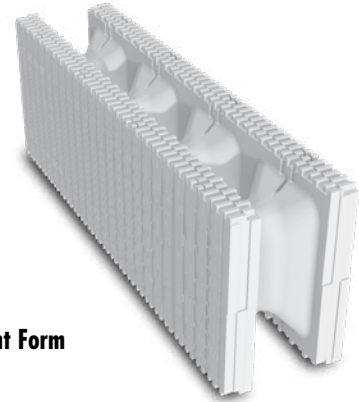

GlobalBlock Straight Form

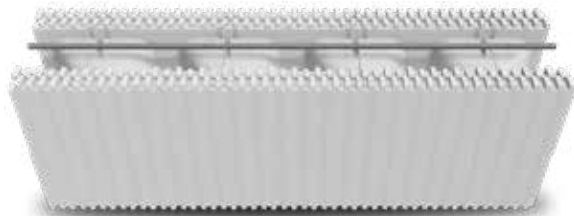

GLOBALBLOCK USING OPTIONAL GLOBALBLOCK REBAR SADDLES.

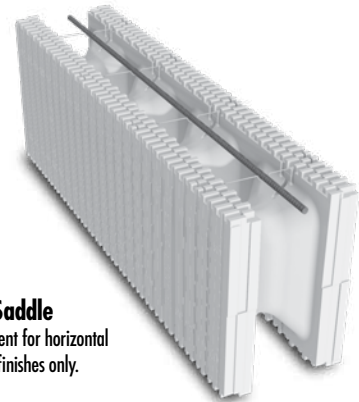

GlobalBlock Rebar Saddle

Optional steel saddle provides placement for horizontal rebar installation. Stucco or EIFS finishes only.

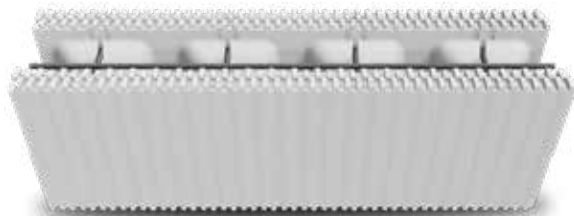

GLOBALBLOCK USING OPTIONAL REBAR PINS.

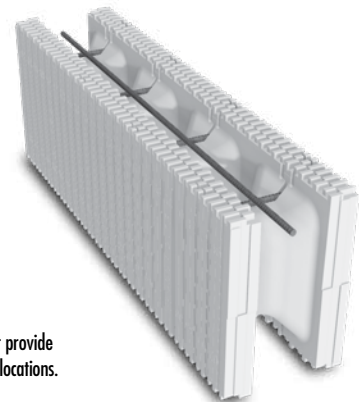

Rebar Pins

Cut pieces of #3 steel rebar provide horizontal rebar placement locations.

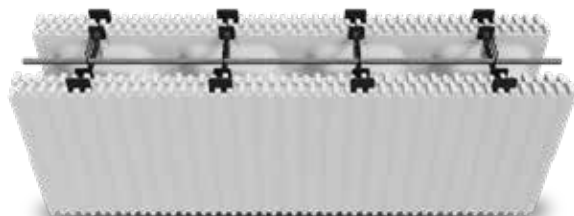

GLOBALBLOCK USING OPTIONAL GLOBALBLOCK WEB INSERTS.

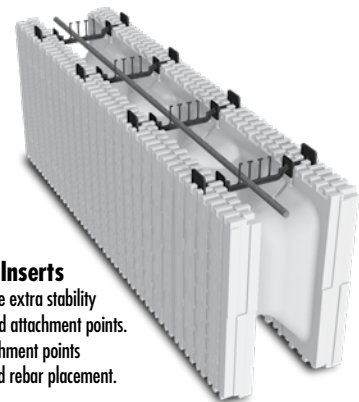

GlobalBlock Web Inserts

Starter Web Inserts provide extra stability on the bottom of the first course and attachment points.

Web Inserts provide attachment points for interior or exterior finishes and rebar placement.

GLOBALBLOCK INSTALLATION, TECHNICAL AND ENGINEERING MANUAL

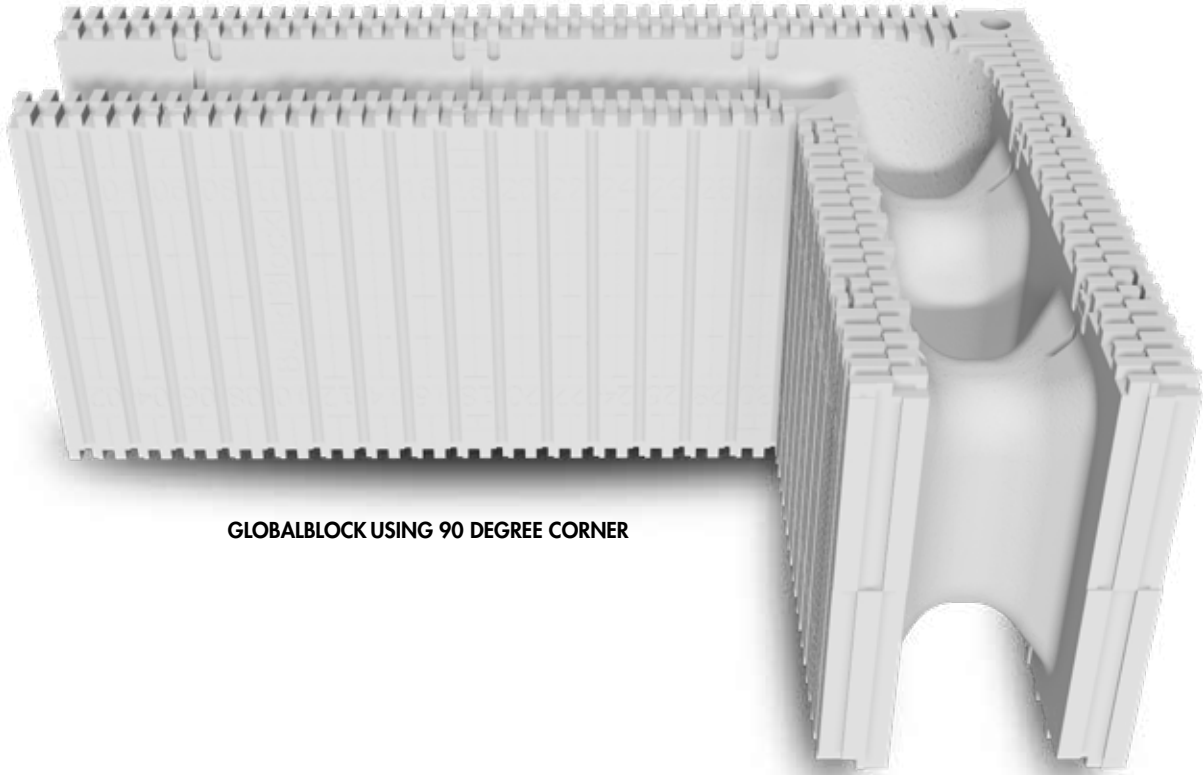

GLOBALBLOCK USING 90 DEGREE CORNER

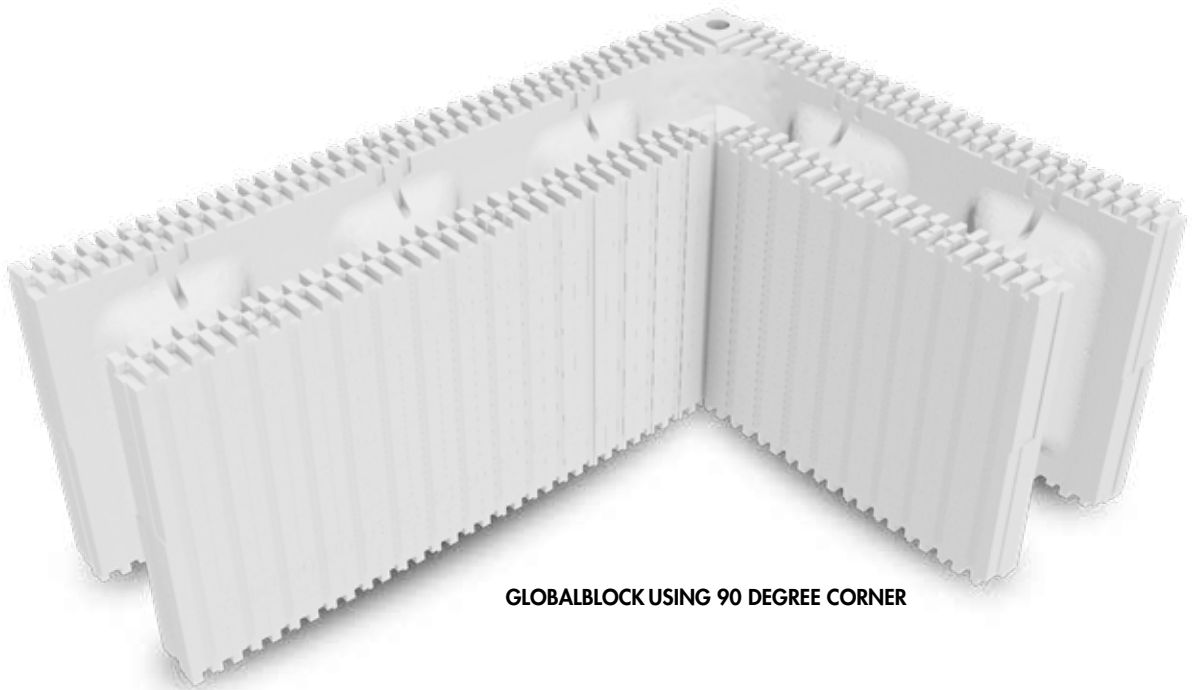

GLOBALBLOCK USING 90 DEGREE CORNER

GLOBALBLOCK INSTALLATION, TECHNICAL AND ENGINEERING MANUAL

GLOBALBLOCK ACCESSORIES

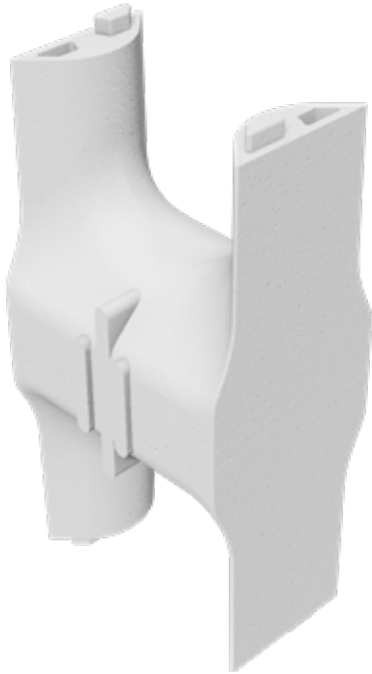

GLOBALBLOCK USING BLOCKOUT

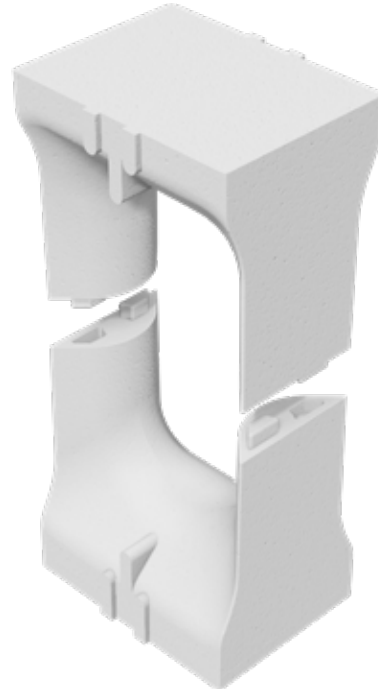

GLOBALBLOCK ENDCAP



GLOBALBLOCK OPTIONAL STARTER WEB

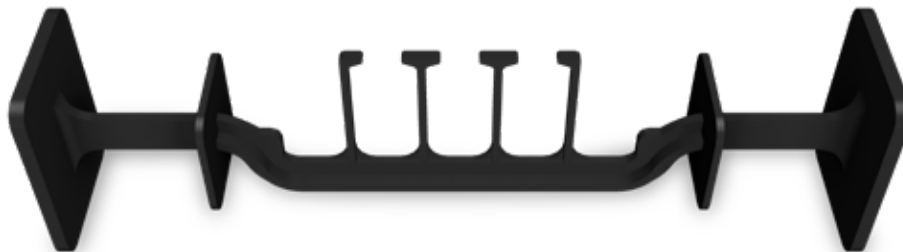

GLOBALBLOCK OPTIONAL WEB INSERT



GLOBALBLOCK REBAR PIN



GLOBALBLOCK REBAR SADDLE

GLOBALBLOCK INSTALLATION, TECHNICAL AND ENGINEERING MANUAL

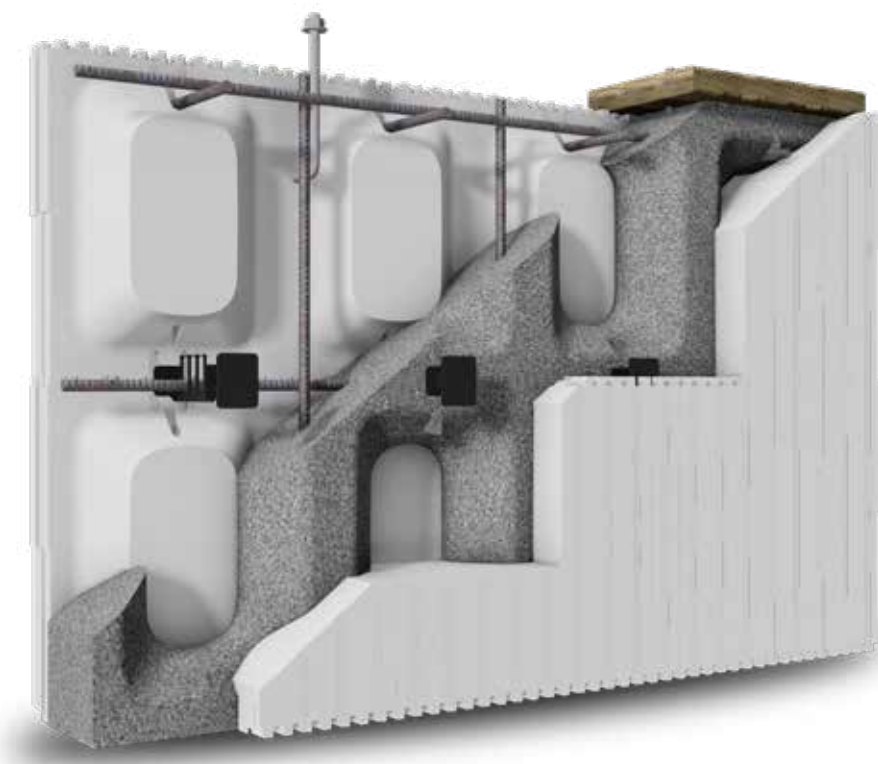

ABOUT GLOBALBLOCK

PRODUCT DESCRIPTION

GlobalBlock is a revolutionary new Insulating Concrete Form (ICF). It is a web-optional design, allowing for much more flexibility in design, and additional cost savings. An evolution of the screen grid design, it seamlessly integrates with other BuildBlock forms to offer a more cost effective ICF solution, while still allowing the use of BuildBlock flat-wall forms in bond beams, lintels, pilasters, safe room walls and other critical areas.

FEATURES AND BENEFITS

GlobalBlock offers a lower cost alternative to a flat wall ICF. It is designed to save you money in a number of ways. GlobalBlock was designed using foam webs with optional plastic web inserts for attachments. Eliminating the structural plastic webs helped create an economical and very strong ICF block. Smaller webs are available as accessories, and can be inserted into slots in the block where mechanical attachment points are needed. The large foam webs dramatically reduce the amount of concrete required, and also result in a higher R-Value for the completed wall system.

USES AND APPLICATIONS

GlobalBlock is used as an alternative to flat wall ICF systems and as infill within a BuildBlock wall. It can be used above grade, as interior walls, and the 6" block can be used as basement walls. Engineering is even available for high wind zones.

INTEGRATION WITH BUILDBLOCK AND BUILDLOCK

GlobalBlock is based on a standard BuildBlock design, and will integrate easily with other BuildBlock and BuildLock forms. The forms are 16" tall and 48" long, and 7", 9", 11", or 13" wide, with only the 9" and 11" (4" and 6" core forms available initially).

GLOBALBLOCK INSTALLATION, TECHNICAL AND ENGINEERING MANUAL

GLOBALBLOCK SPECIFICATIONS

BLOCK	LENGTH	WIDTH	HEIGHT	R-VALUE	CONCRETE VOLUME	SQ. FT. (FACE)	CORNER LENGTH EXTERIOR – INTERIOR	CORNER RETURN EXTERIOR– INTERIOR
GB300	48 in 1219.2 mm	7 in 177.8 mm	16 in 404.6 mm	20.28	0.030660 yd ³ .023441 m ³	5.33 ft. ² .4951 m ²	-	-
GB390	-	7 in 177.8 mm	16 in 404.6 mm	20.28	0.040423 yd ³ .030905 m ³	7.11ft .6605 m ²	38 in – 31 in 965.2 mm – 787.4 mm	26 in – 19 in 660.4 mm – 482.6 mm
GB400	48 in 1219.2 mm	9 in 228.6 mm	16 in 404.6 mm	26.23	0.043906 yd ³ .033568 m ³	5.33 ft. ² .4951 m ²	-	-
GB490	-	9 in 228.6 mm	16 in 404.6 mm	26.23	0.050831 yd ³ .038863 m ³	7.55 ft. ² .7014 m ²	40 in – 31 in 1016 mm – 787.4 mm	28 in – 19 in 711.2 mm – 482.6 mm
GB600	48 in 1219.2 mm	11 in 279.4 mm	16 in 404.6 mm	29.76	0.062947 yd ³ .048126 m ³	5.33 ft. ² .4951 m ²	-	-
GB690	-	11 in 279.4 mm	16 in 404.6 mm	29.76	0.084626 yd ³ .064701 m ³	8.00 .7432 m ²	42 in – 31 in 1066.8 mm – 787.4 mm	30 in – 19 in 762 mm – 482.6 mm
GB800	48 in 1219.2 mm	13 in 330.2 mm	16 in 404.6 mm	31.57	0.088959 yd ³ .068014 m ³	5.33 ft. ² .4951 m ²	-	-
GB890	-	13 in 330.2 mm	16 in 404.6 mm	31.57	0.128151 yd ³ .097978 m ³	8.44 ft. ² .7841 m ²	44 in – 31in 1117.6 mm – 787.4 mm	32 in – 19 in 812.8 mm – 482.6 mm

BUILDING WITH GLOBALBLOCK

SECURING THE BASE

Chalk the wall outlines onto the footing. Once chalk lines have been placed square to the correct dimensions, stack the first 2 courses making sure the vertical cavities align. This can be achieved easily by laying from each corner to a common seam at least 6-feet (1.8 meters) from a corner. (Placing the common seam at a door or window will simplify the process and save cutting) Once the first two courses are in place, level and plumb to the chalk line, by cutting the foam or shimming the wall to level.

After the wall is positioned properly use low expansion foam adhesive to glue the GlobalBlock to the footing. Start at the highest point and work your way around with a small amount of foam adhesive, approximately every 18" (457 mm) inside and out. Poke the tip of adhesive into the open space of the interlocks and avoid any movement of the block for about 15 to 20 minutes or until foam has set. After the glue has set, a full bead can be applied to secure GlobalBlock forms in place. Caution, trying to lift the block to place a full bed of foam adhesive before tacking down could result in movement or lifting of the GlobalBlock forms.

The foam does expand, so recheck your level before continuing. If modifications have to be made, simply cut the foam adhesive and trim or shim as required and repeat the procedure. You can also add 2X4 cleats to the outside to further reinforce the base of the block if needed. Avoid jarring the wall for 15 to 20 minutes or until foam has set fully. Check all walls again for plumb and dimensions.

If you are using the plastic webs, it is recommended that you use the starter web (similar to the standard web, but without rebar fingers) to reinforce the base of the block and to provide attachment points for drywall, etc. GlobalBlock starter webs are inserted into the base of the block to provide an attachment point for drywall and trim, and also to assist in supporting the base of the block during the pour. The starter web is inverted (to the orientation of the standard webs) and inserted into the cutouts in the form. The web will sit flush with the nubs on the footing or slab. A small amount of glue can be added to these if the forms are bridging a low spot.

Cement mortar can also be used as a setting and leveling material in place of the foam adhesive. The mortar should be stiff enough to allow for leveling. Place the mortar with a pointed trowel in a small mound, similar to setting block. Press the block into the mortar and align with a string level or laser level. The mortar will require longer than the foam to set, unless a faster setting material or additive is used. It may be necessary to add a small bead of mortar to the outside of the block to ensure it doesn't move.

A steel track or angle placed at the base of the forms may also be used for securing the bottom of the form to the footing or slab, and can also provide a nailing flange for interior and exterior finishes. This is optional, and performs the same job as the starter web. This angle or track should be nailed or screwed down with appropriate fasteners. It may still be necessary to add foam glue to level the forms. BuildBlock recommends using a 20ga or lighter metal angle, equivalent to metal studs. This will allow attachment of common drywall screws for metal studs.

GLOBALBLOCK INSTALLATION, TECHNICAL AND ENGINEERING MANUAL

Optional wood cleats may also be glued or nailed to the footing or slab once the blocks have been set with either the foam glue or mortar method. The purpose of the cleat is to provide additional support against the pressures exerted on the base of the forms during the wall pouring process and should not be removed until concrete has set sufficiently to relieve the fluid pressure at base of the wall. (Top of pour should be firm or hard to the touch.)

GlobalBlock is an all foam product, and as such, is more delicate than a traditional flat wall ICF with hard plastic webs. Much more care should be used with this product when pouring and vibrating. Slump and lift height should be very consistent to provide the crew with predictable results. The webs are foam, and are more delicate than polypropylene webs. If the web cracks during the pour, stop immediately and move to another area further down the wall. Add reinforcement to the area, (plywood or 1X strapping) and as the concrete stiffens, you will be able to continue with the pour. Any bulges can be rasped off after the concrete has set to ensure the wall is plumb.

Pour slowly and listen to the walls. Even though we have tested this block and found it to be the strongest screen grid ICF on the market, it requires more care and attention to detail than our standard blocks. Once you get used to the product and its characteristics, you should be able to pour GlobalBlock at about the same rate as our standard BuildBlock forms.

Unless a retarder is used in the concrete mix the fluid pressure will be reduced significantly within a half hour to forty-five minutes in normal conditions. This is about the time it would take to place the first lift around the perimeter of an average foundation. Time will vary with temperature. E.g. concrete takes longer in colder weather, etc.

STACKING FORMS

When stacking the forms above the bottom course make sure that the overlap is at least 12 inches. When stacking from a corner, this is automatically set. Stack the block by resting it against the previous form to gauge the location for the end nubs.

Begin by setting the nubs furthest from the last block and working toward it. This tightens the previous course together and helps ensure that the remaining courses will align. (Note: It is always a good idea to stack the bottom course as two (2) courses to ensure the forms will fit together above. Stacking only one course, can cause a number of connection issues.) When integrating with Standard Flat Wall forms, use the same procedure.

The forms may be spot glued once they are stacked to prevent wind lift or concrete float, but this is usually not necessary. Spot gluing is most advantageous on the top course. When stacking from a dead end wall, make sure that the vertical cores align as you work your way up. If working toward a common seam, it may be necessary to modify the forms to ensure the concrete cores are spaced 12" (305 mm) or less.



GlobalBlock Starter Web

GLOBALBLOCK INSTALLATION, TECHNICAL AND ENGINEERING MANUAL

INTERSECTING BLOCKS AND T-WALLS

When fabricating a "T" wall it is important to ensure that there is enough concrete at the joint to keep the walls tied together. All "T" walls should have appropriate diameter steel with the approved overlap for the diameter crossing the joint.

When cutting into the foam web, it is recommended to use a bent wire hot knife, with a profile matched to the webs of the block. Foam glue the seams and brace with lumber, both directions to ensure the corner doesn't pull apart.

When lacing the joint, you will need to remove some of the nubs to allow the blocks to inset with the upper and lower courses. These areas should be foamed to reinforce the connections.

"T" walls can occur at any point along a wall. Ensure that they are aligned to one of the points in the block as shown above. This can be done by starting with the preferred layout at the "T" and working toward a control joint or slip joint above a door or window. This will allow for web alignment when applying drywall or other mechanically fastened finishes.

It is important to verify that all concrete cores are aligned. Misalignments will affect, not only the pour, but also the structural integrity of the wall.

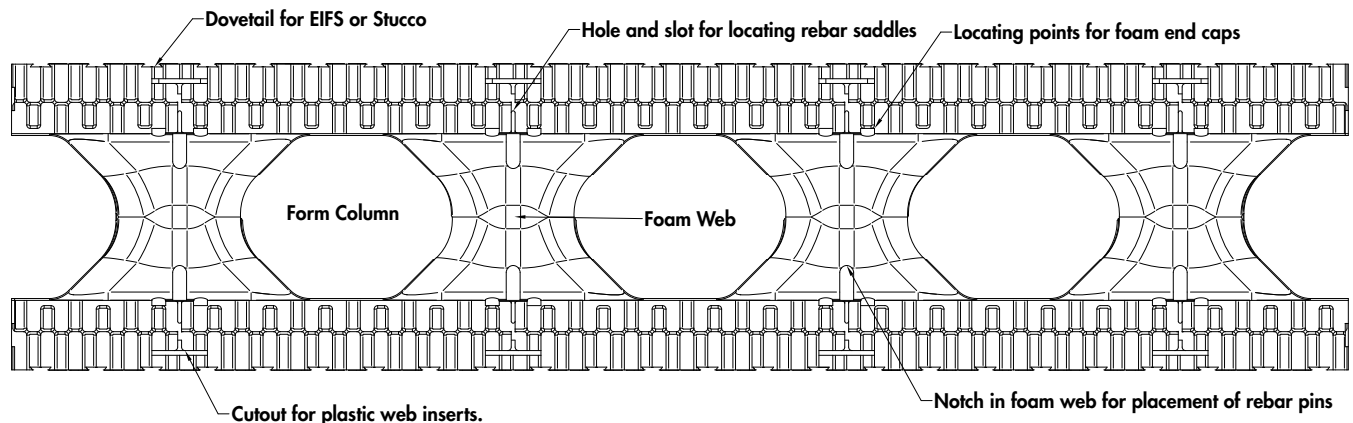

GLOBALBLOCK INSTALLATION, TECHNICAL AND ENGINEERING MANUAL

Always brace on outside of "T" and pour away from this area, allowing it to fill from main wall.

Foam wire-cut to increase concrete core size at "T".

Brace in corners with wood strapping to ensure corner doesn't pull apart.

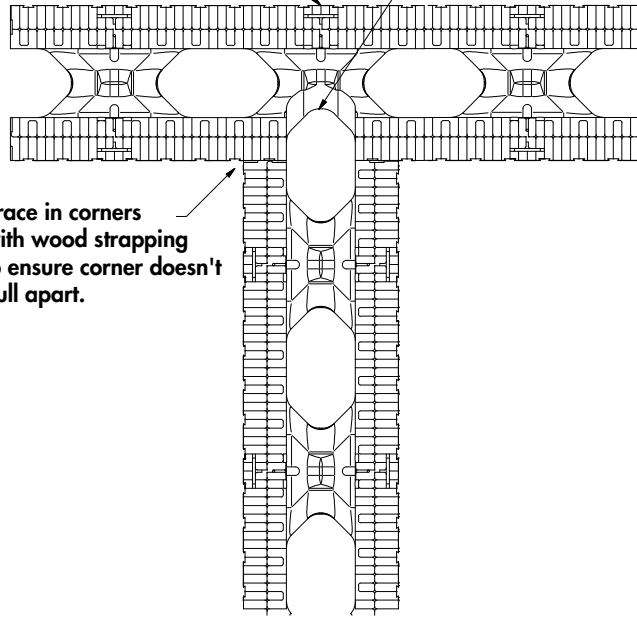

"T" WALL JOINING AT FOAM WEB

Foam Panel removed to join concrete cores at "T"

Foam cut out to inset "T" into main wall.

Alternating courses with these two cuts will create a stronger "T" joint during the pour.

"T" wall set at face of main wall. (Note: the form was cut short to maintain spacing of webs when "lacing" the "T" by inseting 1 block and setting the next course at the face. This can help to reinforce the "T" wall joint.)

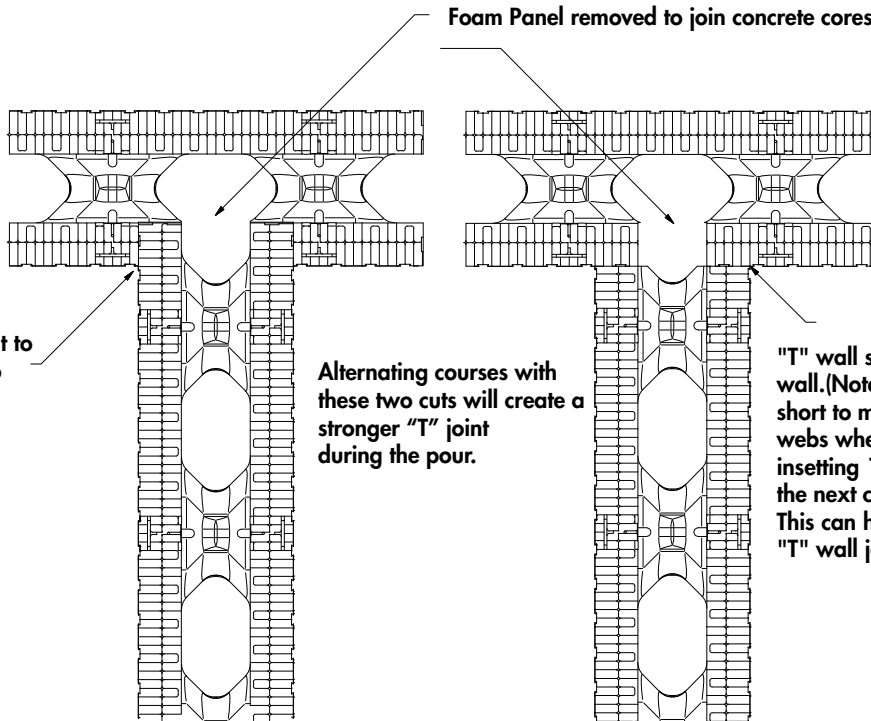

"T" WALL JOINING AT CONCRETE CORE

GLOBALBLOCK INSTALLATION, TECHNICAL AND ENGINEERING MANUAL

REINFORCEMENT

A NOTE ABOUT REBAR

When placing steel in an ICF wall, a good practice is to “lace” the horizontal rod as you go up the wall, alternating from the 1st position to the third position on the rebar fingers of the webs. This allows your vertical rebar to be placed in between the horizontal rod and is effectively “Non-Contact” tied.

SETTING REBAR

There are 3 ways of adding the horizontal reinforcement to GlobalBlock. Horizontal reinforcement should always be offset where possible from one course to the next, in order to capture and restrain the vertical rebar between the horizontal bars. Keep the bars close together (spaced by one rebar finger). Typically steel is offset either side of center, allowing vertical rebar to be centered.

If engineering requires rebar to be to the outside or inside of the wall, offset horizontal rebar to one side or the other as required by engineering. This adds to the strength of the finished wall, by allowing the bars to transfer loads between the horizontal and vertical reinforcement.

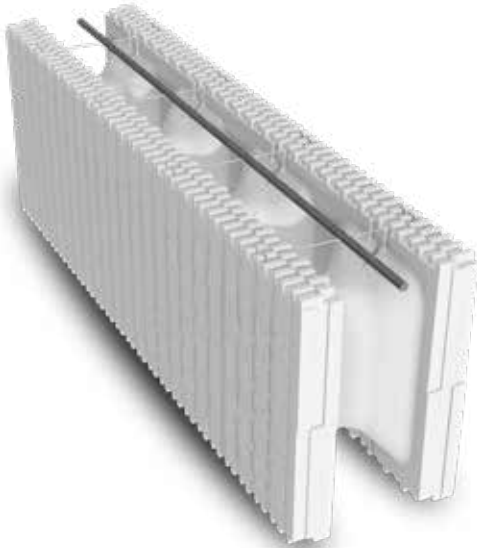

REBAR CROSS-PINS

Using the rebar cross-pins for setting rebar is recommended for applications which do not require attachment points throughout the wall. The pins rest in the molded slots in the foam webs, and align the horizontal rebar below the centerline of the horizontal concrete beams.

The cross-pins are also used at the top course to ensure that the rebar rests in the top block course to provide reinforcement, and also has adequate concrete cover. Use 1/2" rebar pins. This may require tying horizontal bar with wire to insure vertical and horizontal steel locations meet the minimum 3/4" concrete coverage.

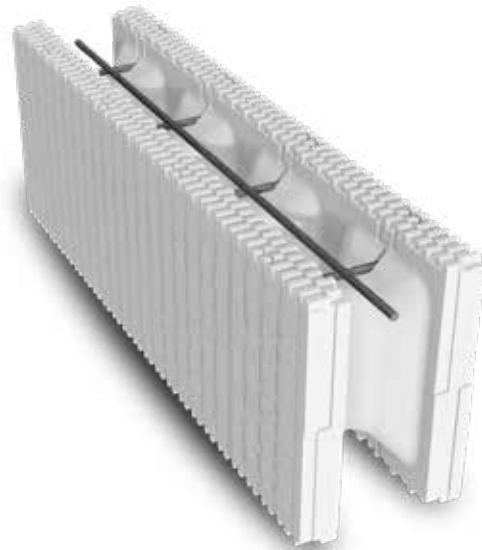

REBAR SADDLES

The Saddles are thin wire parts, which rest in molded slots, to accurately locate the rebar, and allow for variable placement of the horizontal rebar offset from the center of the cavity to surround the vertical rebar. The saddles do not offer any attachment points and offer a low cost alternative to the plastic webs when using stucco and plaster finishes. The saddles are deep enough to allow for rebar to be lap spliced.

The bar resting on top of a finished wall may need to be bent downward (on the top course) to maintain adequate cover on the steel to meet ACI requirements. The top course of saddles should be pressed further into the foam, lowering the center of the reinforcement and providing the minimum 3/4 inch concrete cover from the rebar to the top of the wall.

GLOBALBLOCK INSTALLATION, TECHNICAL AND ENGINEERING MANUAL

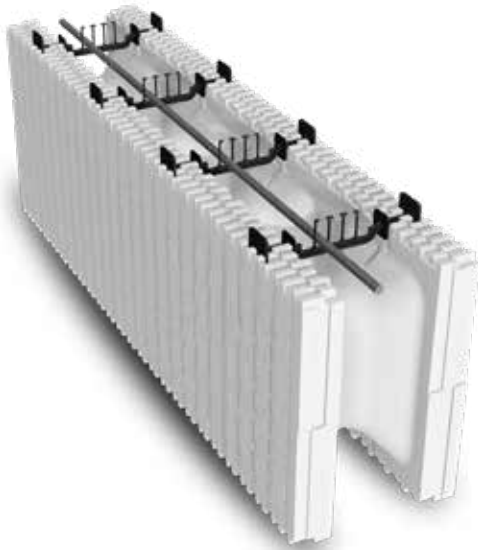

PLASTIC WEBS

GlobalBlock has an optional plastic web that can be inserted into the block while stacking. The webs feature Rebar fingers to align the horizontal courses of reinforcement. The webs lower the rebar into the horizontal core and will hold two pieces of rebar to simplify splicing.

There are multiple rebar locations available for alternating the horizontal reinforcement, and effectively caging the vertical reinforcement between them. The webs also increase the overall strength of the block during pour, and allow for simpler attachment of bracing. The plastic webs are used when you need mechanical attachment points on the inside or outside of the wall.

The webs offer a 2-1/2" x 2" attachment point, on 12" centers horizontally and 16" centers vertically. They are marked by an outline on the face of the block for easy identification prior to drywall or other finish applications. These attachment

points are suitable for siding and drywall; attaching metal lath sheets for traditional stucco applications as well as attaching a bracing/alignment system.

CUTTING BLOCK

Cutting Block - Vertical cut lines are shown every inch, and are labeled every two inches. The horizontal cutlines are shown every 2-inches (51mm) from the center of the nubs.

Half course block – Cutting a GlobalBlock form in half is a simple procedure. There are no hard plastic webs to cut around when using a hot knife. The block can be cut easily with a number of tools. The best cutting method is a hot wire table or a small handheld shark-tooth saw designed for cutting wood.

It may be necessary at times to use a hot knife with a loop bent to match the profile of the beams for creating horizontal beams and lintels. This is recommended around openings to ensure at least a half post or beam on all sides.

It is necessary to reinforce or mark this area and take extra care depending on how much foam was removed from the web prior to pouring concrete as this will create a stress point during the concrete pour.

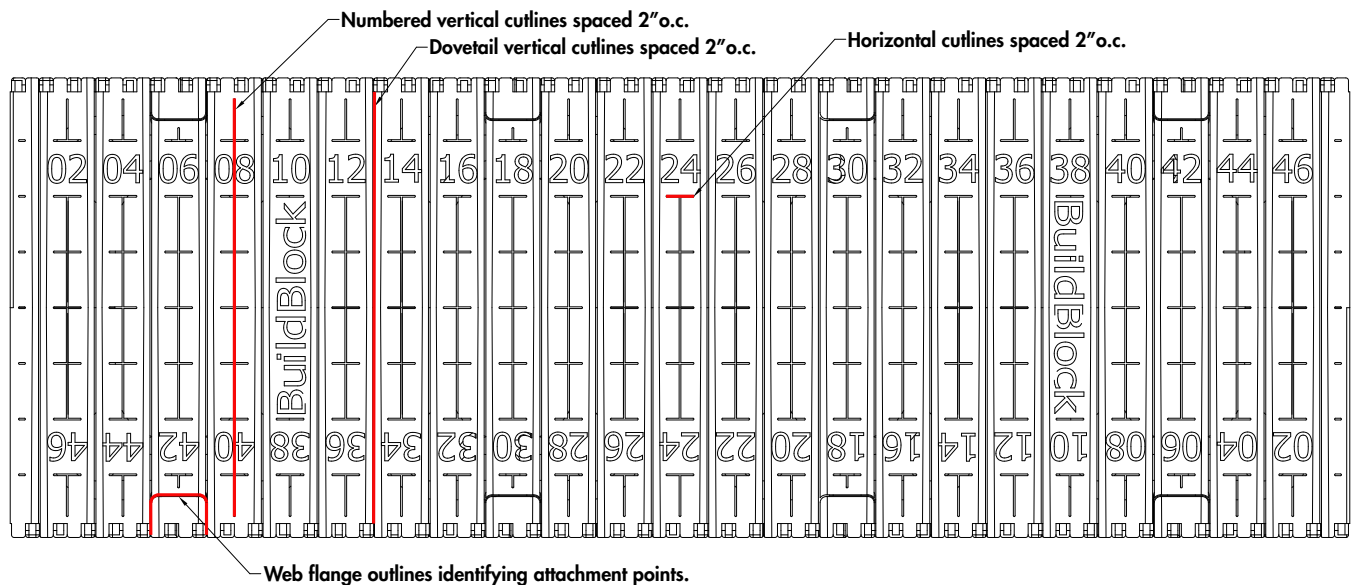

GLOBALBLOCK INSTALLATION, TECHNICAL AND ENGINEERING MANUAL

USE OF END CAPS

GlobalBlock end caps are used to terminate walls, as bucks at openings, and anywhere else a smooth foam or concrete face is desired. The end caps are 8" thick, and can be left in place or trimmed to any desired dimension after the concrete is hardened. The foam will create a smooth, flat end for the walls, and if removed will leave a similar face in the concrete.

Foam Glue is recommended for the end caps, but is not required. There may be some concrete fluid pushed through at the joints without foam glue, but this should be a minimal amount.

The fully reversible end caps are connected at the centerline of each course with a pair of nubs. These help to align the end caps to provide a smooth flat concrete face along the full height of the wall.

To cut an end cap for use on the bottom course, you will follow one cutline, and use the larger piece. The end caps are designed so when they are cut at the cut lines, they provide a top and bottom course cap. The smaller piece should be saved and used at the top of the wall. The cutlines are off center to allow for the nub depth on the top and bottom of each form. The top half of the end cap (smaller piece) allows for the nubs to be removed at the top of the wall to flush the wall for the top plate if desired.

Once the concrete has been poured and set, the end caps can be trimmed or removed completely by rasping, sawing, or with a hot knife. Full removal will leave a smooth flat concrete edge to attach framing or jambs to. Leaving a thickness of foam in that area, and fastening through it will provide an insulated buck between the jamb and the concrete core.

The end caps may also be cut in half vertically, at the center of the saddle for the foam web, and placed so that the concrete pressure is against the non-cut face. It is held in place by the foam web of the block. It is recommended to use the expanding foam adhesive when using the end caps in this manner.

GLOBALBLOCK ANGLES

When cutting GlobalBlock at angles other than 90 degrees, be sure to measure carefully. The cut will be half of the desired angle. For instance, if you need a 45 degree angle, it will be necessary to cut a 22.5 degree angle and rotate the pieces so that they align into the proper angle. It is also critical to adjust the layout of the angle to ensure that there is a concrete core

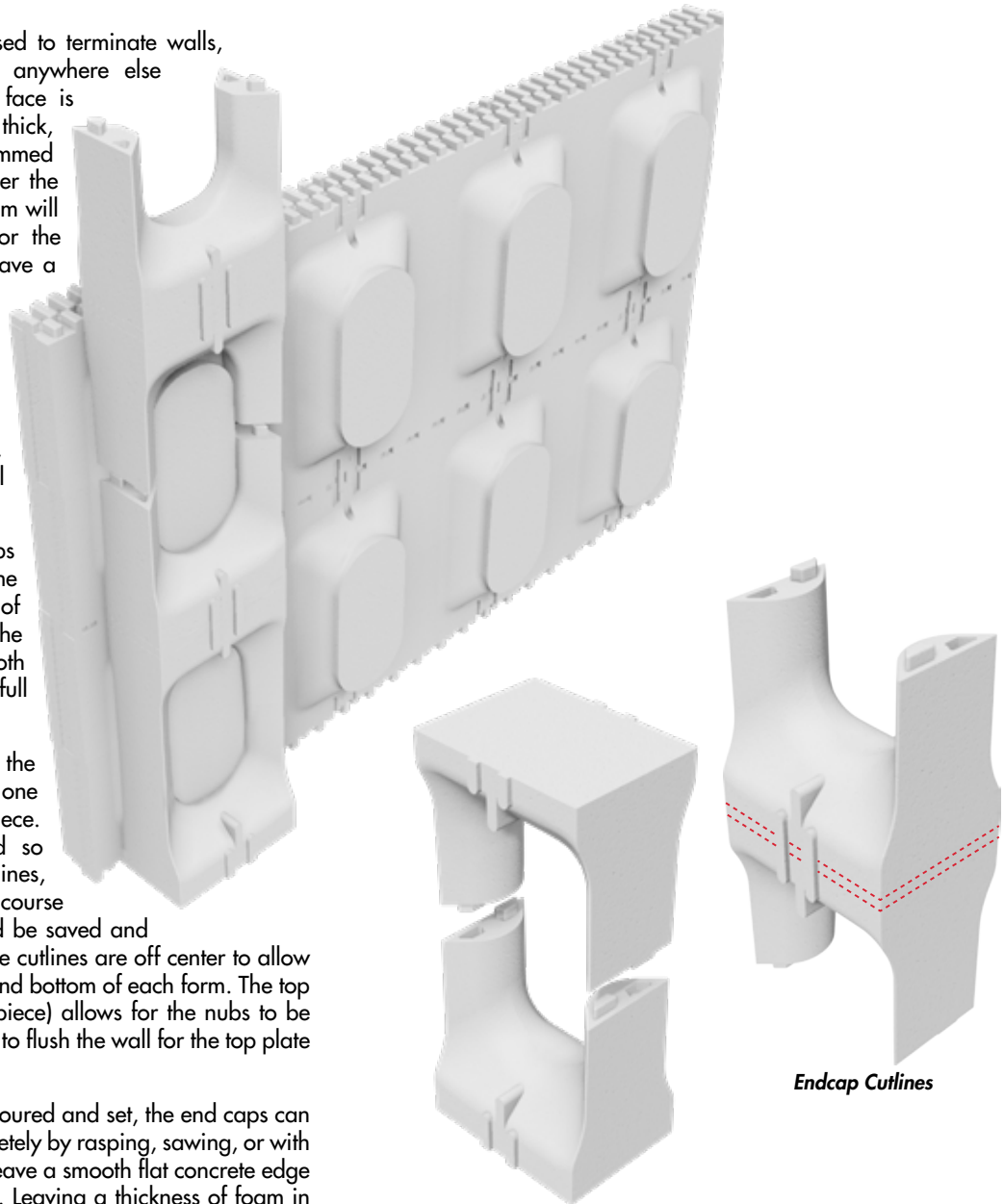

Endcaps after cutting. Note the alignment of the nubs.

at the corner, and not only foam. You can cut out some of the foam web to enlarge this area if necessary, but be sure to provide additional reinforcement anytime you are modifying the web or cutting angle blocks.

GLOBALBLOCK INSTALLATION, TECHNICAL AND ENGINEERING MANUAL

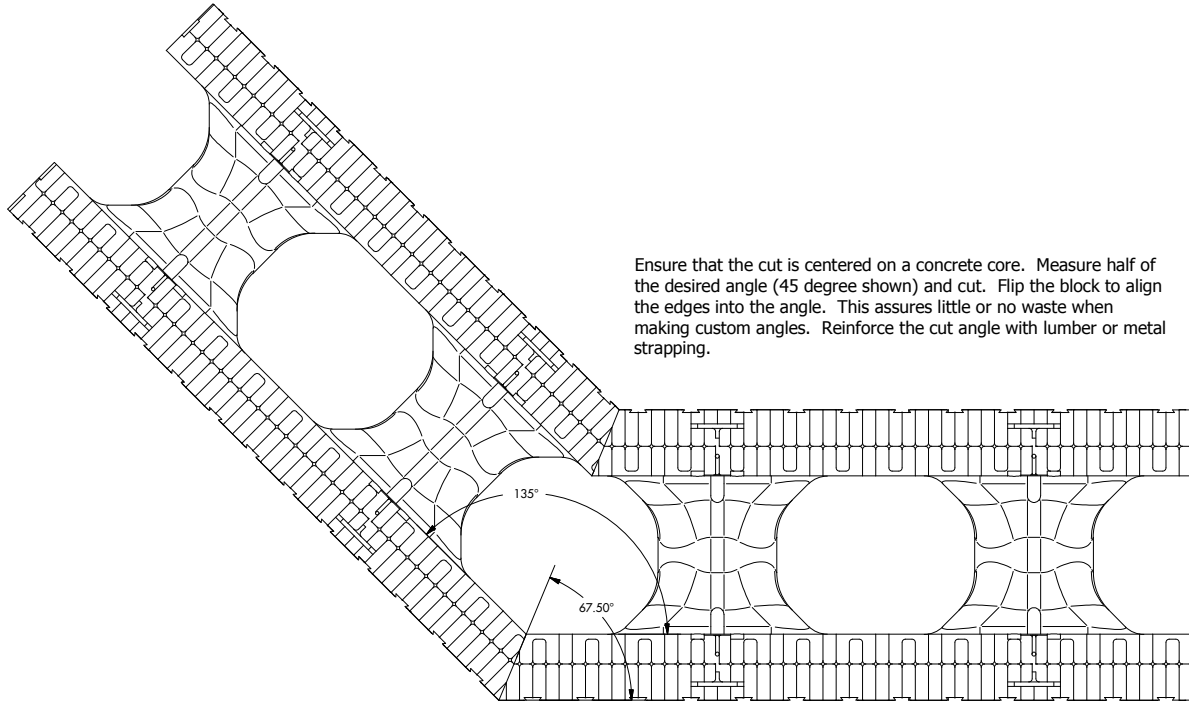

Ensure that the cut is centered on a concrete core. Measure half of the desired angle (45 degree shown) and cut. Flip the block to align the edges into the angle. This assures little or no waste when making custom angles. Reinforce the cut angle with lumber or metal strapping.

PENETRATIONS

One of the simplest and most effective methods of adding service penetrations to an ICF wall is to cut a piece of PVC pipe into a saw tooth pattern at one end. Use this to drill the hole (which will be perfectly round and the same diameter as the PVC) through the ICF, and extend to the other side. You can use this as a cutter if you have several holes to make, or leave it in place if you only have one.

Sealing service penetrations through GlobalBlock is done much the same as with standard blocks. Once the hole is cut, and the PVC pipe is inserted through it, seal around it with expanding foam adhesive. It is a good practice to reinforce this area prior to pouring concrete. Once the pour is complete you can trim the PVC pipe to be flush with the wall. Seal it with foam adhesive after services have been installed. You may also need to add waterproofing to this area if it is below grade, or screening to prevent pests from tunneling through it.

Adding penetrations after the pour is much easier with GlobalBlock than with the standard flat wall form. Locate the foam area of the web (look for the outlines of the plastic web inserts embossed onto the face) and cut out a hole with a hole-saw or hot knife to add the PVC pipe in this area. Foam glue around it as before. There is no need to cut the concrete, as with traditional ICFs. Electrical boxes and plumbing connections of almost any depth can be located in the foam web areas as well.



GLOBALBLOCK INSTALLATION, TECHNICAL AND ENGINEERING MANUAL

WINDOW AND DOOR OPENINGS

When placing windows and doors, it is imperative that there is at least a half core along each side of the opening, as well as the top and bottom. Rebar must be placed within 6" of each side of the opening as well as above for lintel strength. (See the lintel table and details for additional information.) The concrete can be isolated from the window or door frame by foam, or wood, vinyl or other buck systems. Bucking Options for use with GlobalBlock are essentially the same as with standard ICFs, with one notable exception. Using the end caps and then trimming them back to one inch thickness will create an integral insulated buck. See Cutting Block for more details about using the end caps. Other commonly used bucks are Gorilla Buck, V-Buck, Insul-Buck, Pre-Buck, and treated lumber.

Sometimes it will be necessary to modify the foam web to place a concrete core where it is needed around openings or at corners. See detail below showing the preferred dimensions to cut to maintain the shape of the cores. Remember to always reinforce any area that has been modified this way.

LINTELS

Lintels are built into GlobalBlock similarly to how they are built into a flat wall system. It may be necessary to open up the horizontal and vertical cores to ensure adequate concrete cover. See the profile shown in the detail sheets at the back of this manual. It is important that when the top course is stacked that it is glued down to prevent any lifting.

GlobalBlock should have one stirrup in every vertical core across any lintel over 2' long. (See engineering) .

It is important to ensure that you have an adequate beam at the top of the wall to ensure proper concrete cover of the reinforcing steel. This is especially important above an opening. It is also prudent to check for point loads over any openings. If there is any concern, it is advisable to use a standard flat wall form for the lintel, to ensure that the wall will perform as intended. GlobalBlock can also be converted into a flat wall form or waffle grid form by cutting out portions of the webs and bracing in place with lumber.

The minimum beam size above openings is half of a beam. The minimum post size for each side of an opening is one-half of a vertical post. It may be necessary to modify the blocks to achieve this. Remember to reinforce all modified blocks.

Using BuildBlock Flat-Wall forms as bond beams or lintels provides a much simpler layout for the lintels. Ensure that the standard form rests over a full GlobalBlock column on each side of the opening, and 2 columns on wider openings. (It is advisable to extend the flat wall forms at least 2' on either side of the opening to fully embed the lintel rebar.) Optionally BuildBlock standard flat wall forms may be used as a bond beam at the top of a wall or in the corners helping lock the entire structure together and providing additional strength to headers, lintels, and roof attachments.

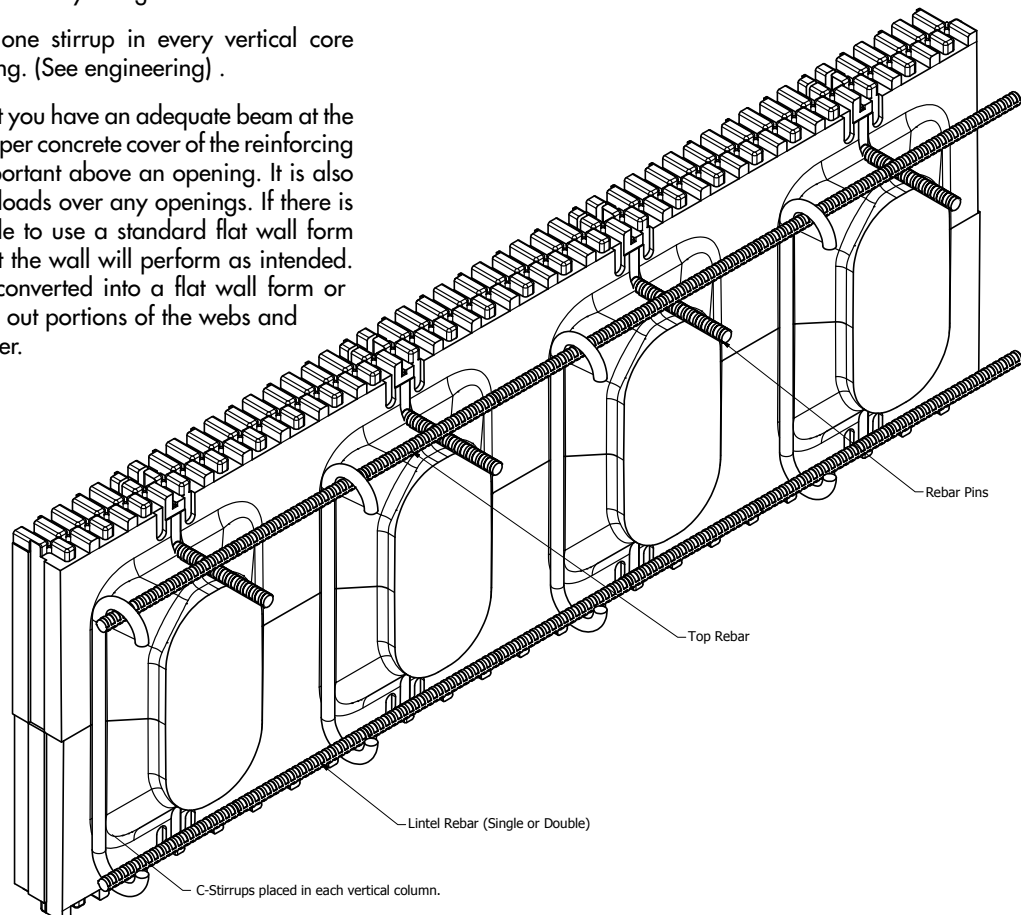

GLOBALBLOCK INSTALLATION, TECHNICAL AND ENGINEERING MANUAL

BRACING

As with any ICF, adequate bracing is a critical part of ensuring a quality job. With GlobalBlock, there are several different options for attaching the bracing to the wall. When using the plastic web inserts, you can just screw into these as you would with any standard ICF.

When not using the inserts, loop a short piece of tie wire, bent in half, and spaced approximately 3 1/2" wide, through the wall between the courses. Leave ample room to slide a 2x4 through the loop outside of the wall.

As you set the bracing system on the inside of the wall, simply pull the wire tight to secure the 2x4 and twist the wire around the inside brace. Attach outriggers to these vertical studs to plumb and align the wall for the pour.

SIP SCREWS

An alternative method without the plastic webs is to use SIP screws and attach the bracing through the foam webs into lumber on the back.

This allows the SIP screw to be removed with the bracing and reused. When using these screws make sure they go through the foam web and stay clear of the concrete cores.

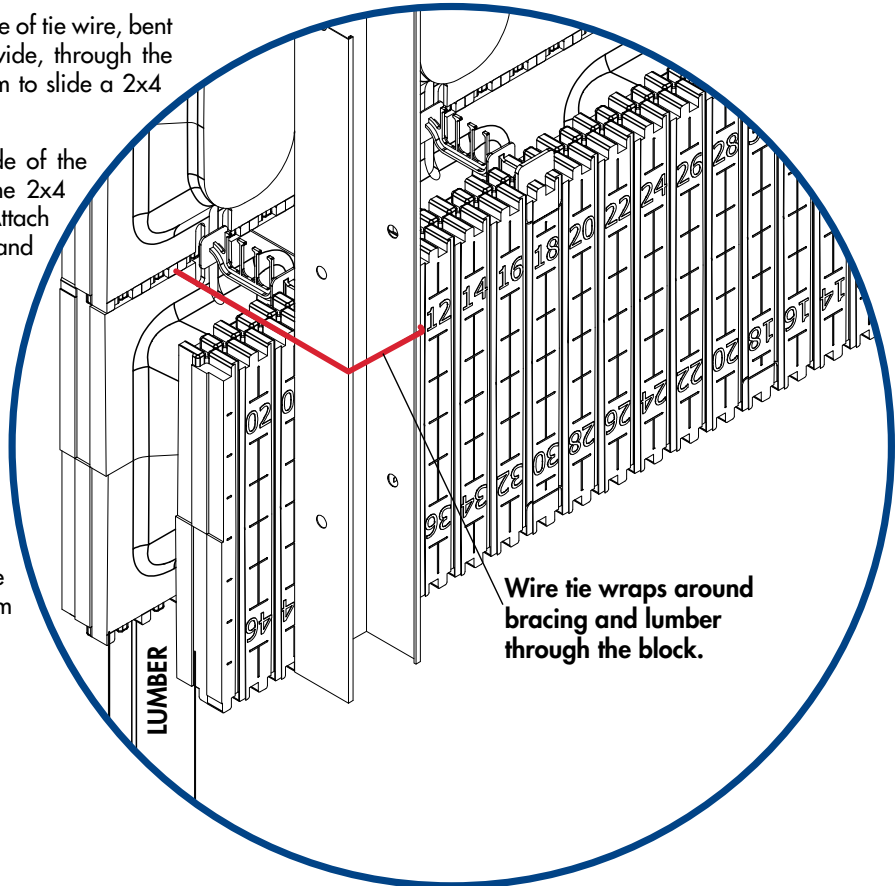

SIP Screw

GLOBALBLOCK INSTALLATION, TECHNICAL AND ENGINEERING MANUAL

CONCRETE DESIGN

ABOUT CONCRETE MIXES

BuildBlock recommends the use of a 3/8" chip or rock mix 3000 PSI or stronger concrete mix for your walls. Your ready-mix plant will most likely have a mix design for a 3/8" chip mix and will refer to it as a pump mix. There are several alterations you can make to the recipe of concrete to combat weather occurrences, such as fly ash and air entrainment. But do avoid adding calcium to your mixes as it has a negative impact on the rebar reinforcement. If pouring in cold weather, have hot water added to formulate the mix.

Depending on the type of material and individual gradation, these ratios may have to be adjusted. Consult with your local

ready-mix supplier. The pump may be the controlling factor (for example, new pump vs. old pump, boom pump vs. trailer pump, etc.).

You may want to make some test cylinders as the concrete comes out of the pump. Take a 5-gallon sample and make five 4" diameter by 8" high cylinders for testing. Your mix design should yield 3000 PSI at a designed slump of 5 1/2" to 6" to pour properly. If not conveyed properly to your concrete company, they may bring out a 3000 PSI mix with a 4" slump design. If you wet it to pour, your concrete will not be 3000 PSI strength. Note: Most common mixes are designed to be wetted to a 6" slump maximum to obtain the mix designed strength. If you have any concerns, just order a stronger mix design (ex: 3500 psi).

TYPICAL 3000 PSI 3/8" CHIP MIX DESIGN			
		WITH FLY ASH	WITHOUT FLY ASH
1.	Cement Content	5.5 bags (517lbs.) 234.5 kg	6.5 bags (611 lbs.) 277.1 kg
2.	Fly Ash* (Class C)	1.5 bags (141lbs.) 310.2 kg	0
3.	Coarse Aggregate** ASTM C-33 #8 100% passing the 1/2 inch screen 85-100% passing the 3/8 inch screen	1270 lbs. 576.06 kg	1270 lbs. 576.06 kg
4.	Fine Aggregate ASTM C-33 (Sand - FM*** 3.70)	1620 lbs. 734.8 kg	1620 lbs. 734.8 kb
5.	Water to make a 5-inch slump to 6-inch slump	40-46 gallons 151.4 liters - 174.1 liters	40-46 gallons 151.4 liters - 174.1 liters
6.	Entrained Air**** (for workability)	4% to 6% or 1 oz. per bag cement/fly ash	4% to 6% or 1 oz. per bag cement
7.	Water Reducer	Encouraged	Encouraged
8.	Recommended Slump	4-inch to 5.5-inch (102 mm to 140 mm) out of the pump	4-inch to 5.5-inch (102 mm to 140 mm) out of the pump

Notes:

*The use of Fly Ash improves the flow ability of the concrete and reduces the amount of Portland cement required. This saves you money and results in a concrete mix which is more "green" in terms of LEED points.

**The maximum aggregate size for 6" block is 1/2" (3/8" is recommended). The maximum aggregated size for 8" block is 3/4" (3/8" is recommended.) The larger the aggregate, the more problems you will have with concrete flow.

***FM = Fineness Modulus for sand.

****6% Entrained Air results in better flowing concrete.

POURING

CONCRETE SLUMP

Proper slump is very important. Do not use less than 4" slump concrete out of the pump hose. Voids could be an issue. Note: We always measure the concrete slump before it ever goes into the pump. A 1/2 inch extra slump will be absorbed by the aggregate during the pumping process so wetting the concrete to a 6" slump will usually give you a 5-1/2 inch slump concrete at the hose end most of the time. Occasionally, sand and aggregate has received recent rain and this may not apply.

Depending on the type of material and individual gradation, these ratios may have to be adjusted. Consult with your local ready-mix supplier. The pump may be the controlling factor (for example, new pump vs. old pump, boom pump vs. trailer pump, etc.).



Concrete Slump cone

GLOBALBLOCK INSTALLATION, TECHNICAL AND ENGINEERING MANUAL

Proper procedures must be followed when taking test cylinders or validation may be compromised.

The required slump should be mixed at the redi-mix plant to avoid “watering down” the mix on site. The use of admixtures as a water reducer is recommended as it will provide the desired slump without losing concrete strength. Admixtures make it possible to adjust slump on site with less water. Note: Most common mixes are designed to be wetted to a 6” slump maximum to obtain the mix designed strength.

Note: Typically adding water at the ratio of 1 gallon per yard of concrete raises the concrete slump by 1”. Be very careful, adding too much water above a 6” slump will greatly weaken the mix design and could cause a failure or wall bulge.

GlobalBlock works best with a lower slump concrete and a slower pour rate. Pouring GlobalBlock will require a slump in the range of 4” – 5-1/2”. It is important to perform a slump test prior to pouring or pumping the concrete to ensure that it will not overstress the system. Lift heights should be limited to 2’ for the first lift and 4’ for the remaining lifts. The pressures generated on the inside of the form increase dramatically with pour rate and higher slump (thinner) concrete.

CONCRETE CONSOLIDATION

IRC 2012: R611.5.1.5 Consolidation of concrete:

Concrete shall be consolidated by suitable means during placement and shall be worked around embedded items and reinforcement and into corners of forms. Where stay-in-place forms are used, concrete shall be consolidated by internal vibration. All walls must be internally vibrated with a 3/4” to 1” powered vibrator.

POURING NOTES

1. Flow concrete to corners when pouring. Stay at least 3-feet from a corner when pouring until close to the top and topping off the wall.
2. When pumping, push the concrete flow at a 45 degree angle so it flows smoothly. Let the concrete flow naturally.
3. Anchor doors and windows with a small amount of concrete on each side before pouring the first lift around these openings.
4. Work closely with pump operator to pour smoothly.
5. Do not **over** vibrate above or along the sides of doors or windows. This will cause the block or bucking to lift and could blow out a block.
6. Do not over vibrate a wall. Over vibration can cause large aggregate to settle to the bottom of the wall.
7. When vibrating the concrete, it is recommended you use a low impact pencil vibrator with a 3/4” or 1” head maximum size. The technique used is fast in slow out with the average pull out rate of 4” to 6” per second. Do not over vibrate screen grid ICFs.
8. Spot glue top course.
9. Pour top course slightly high as it will settle during vibration.
10. Utilize a restrictor end (such as a LL, Double L nozzle) on your boom hose to your boom hose with a 3” max end size to reduce concrete surge. Discuss this with your pumper when ordering your pump. BuildBlock recommends boom pumps for full wall pours.

GLOBALBLOCK INSTALLATION, TECHNICAL AND ENGINEERING MANUAL



CONCRETE DELIVERY SYSTEMS

BOOM PUMPS

Boom pumps work the best because they have full job site access from one place. There is no "hose factor," and it can move a tremendous volume quickly.

HOSE TYPE

BuildBlock recommends a 3-inch "Double L" or a 3-inch Flat Hose (Mud Snake). These provide additional concrete flow control and make it safer for the person directing the pour.

TRAILER PUMPS

Typically used for smaller applications, trailer pumps are sometimes used for big jobs. The down side is hose management (heavy hose across ICF walls) and pumping lesser concrete volumes which results in a slower, longer pour time. A 2" hose for the last 25' feet is required. A 3" hose will be too heavy to handle.

TRUCK CHUTE

Right off the truck chute is done sometimes when the conditions are perfect (like a basement with minimal over dig) and where you are confident you can direct the chute around the job site. However, chute filling can be messy and wasteful and you are more tempted to water down your mix which will decrease its strength.

BUCKET SYSTEM

A bucket system with attached funnel whereby a large container of concrete is hoisted around the site via forklift or other means requires more labor and time.

CONVEYOR DELIVERY

Conveyor delivery is another possibility but only if you have a trunk hose to direct concrete into the wall cavities. Check with local suppliers. Note: Trying to save money by settling for a less efficient concrete delivery system will cost you extra time and labor and will result in a messy job site and probably wasted concrete that will require later clean up.

GLOBALBLOCK INSTALLATION, TECHNICAL AND ENGINEERING MANUAL



BUILDBLOCK EXTERIOR WALL

COMPLETING YOUR GLOBALBLOCK PROJECT

FINISHING

When stacking GlobalBlock for use with siding, drywall or other finishes requiring a mechanical fastener, it is necessary to use the plastic web inserts. These will be located every 12" horizontally and every 16" vertically. This meets the IRC code for drywall screw placement. It is also advisable to add a 3/4-inch schedule-40 PVC pipe into the vertical hole in the corner forms. The holes are designed so that you can use only the splice connectors, at the joints of the block (in the same area as the plastic webs) or a full length pipe.

When attaching 4x8 siding panels, simply screw it into the webs, and add any trim work needed. For lap siding, you must first strip all walls with furring strips before attaching the siding.

Attaching drywall will require the use of drywall screws, and screwing them into the plastic webs. The webs are spaced within the maximum spacing for drywall. You can also apply small amounts of foam adhesive or a foam compatible tube adhesive to the back of the drywall where no attachment is provided around doors, corners and windows.

Stucco with metal lath should be attached with coated deck screws to the plastic webs. It is not necessary to add house-wrap over the foam. The stucco should be pressed into the dovetails as well to assist in mechanically fastening the finish to the wall.

Brick and stone are laid on a ledge or footing, and attached to the walls with brick ties or straps. The webs are spaced well within the code requirements for brick ties. Other types of thin stone and brick may be attached directly to the foam.

For interior or exterior Stucco, Plaster, or EIFS application without wire mesh use the dovetails molded into the face of the block as a means of retaining the finish. Put on a thin scratch coat, pressing it into the dovetails, and apply the mesh into the wet stucco or plaster. It is still recommended to use a fiberglass or similar mesh to reduce cracking in the finish. It is important to apply the scratch coat fully into the dovetails filling them completely to ensure the finish will stay in place. Synthetic

stuccos using fiberglass mesh reinforcing should be applied per stucco manufacturer's recommendations.

WATERPROOFING

BuildBlock recommends covering all below grade EPS with an approved barrier.

Waterproofing for basements and other below grade areas is important, and falls into a couple of main categories. A waterproofing membrane, such as peel and stick sheeting or spray or roller applied liquid waterproofing are used to create a barrier between the soil and the ICF wall. "Air Gap" systems work by creating a void between the soil and the wall, eliminating hydrostatic pressure. The use of both systems is recommended in any area with high humidity, heavy rainfall, high water tables, or localized flooding. Drier areas with lower humidity and water tables can choose between the two options. Install per product instructions for EPS applications.

EXPANDED POLYSTYRENE (EPS) AND UV

It is important to cover any exposed EPS with a suitable finish to prevent UV exposure. This will prevent a gradual degradation of the material, typified by yellowing of the surface. This doesn't affect the insulative factor if covered soon, but if left unchecked, it can wear away at the foam. EPS left exposed below grade will not be affected by water or common soil chemicals but should be covered with an approved barrier to prevent moisture intrusion. EPS foam has no food value deterring pests from creating a chase to get to a food source. EPS does deteriorate in the presence of hydrocarbons such as gasoline, kerosene, or other solvents, as they will melt the foam. Do not use a solvent based coating on ICFs.

GLOBALBLOCK INSTALLATION, TECHNICAL AND ENGINEERING MANUAL

BACKFILLING

Backfilling should only be done once the floor system is in place to provide additional support for the walls. Take care to minimize sticks and large rocks that can damage waterproofing when backfilling against a basement. It is advisable to backfill with crushed gravel and clean non-expansive soil to maintain adequate drainage around the basement to a French Drain or other system.

*****Anything not covered in this document is superseded by the BuildBlock Installation Manual, the Prescriptive Method, Local or International Codes, or Project Specific Engineering.**

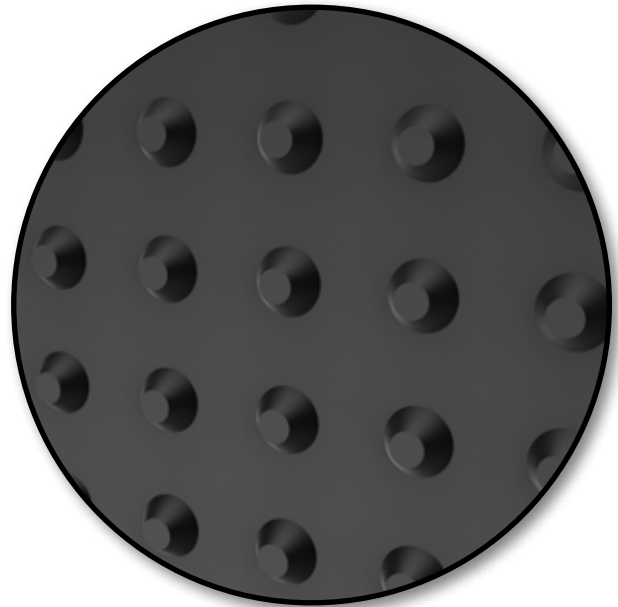

ICFs use below grade dimple or adhesive membranes for waterproofing keeping your basement warm and dry.

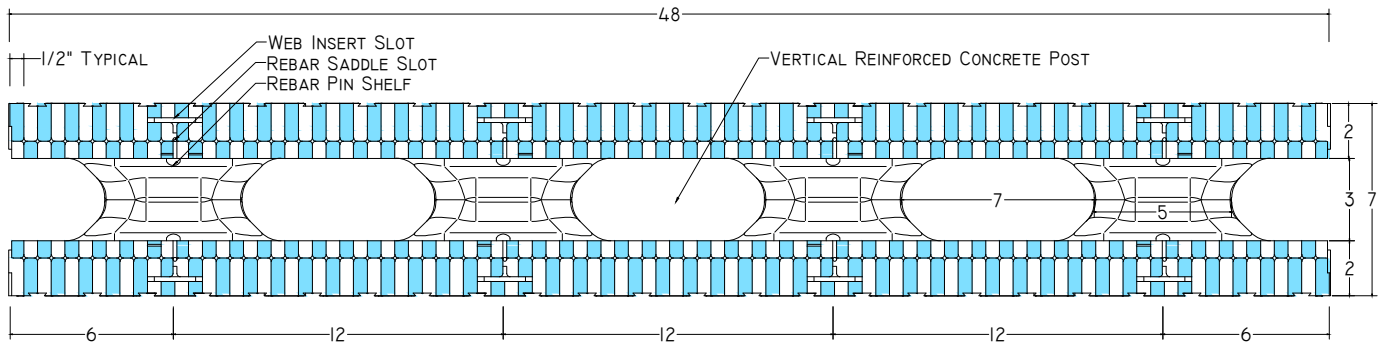

1 TOP / BOTTOM VIEW (REVERSIBLE)
SCALE: NTS

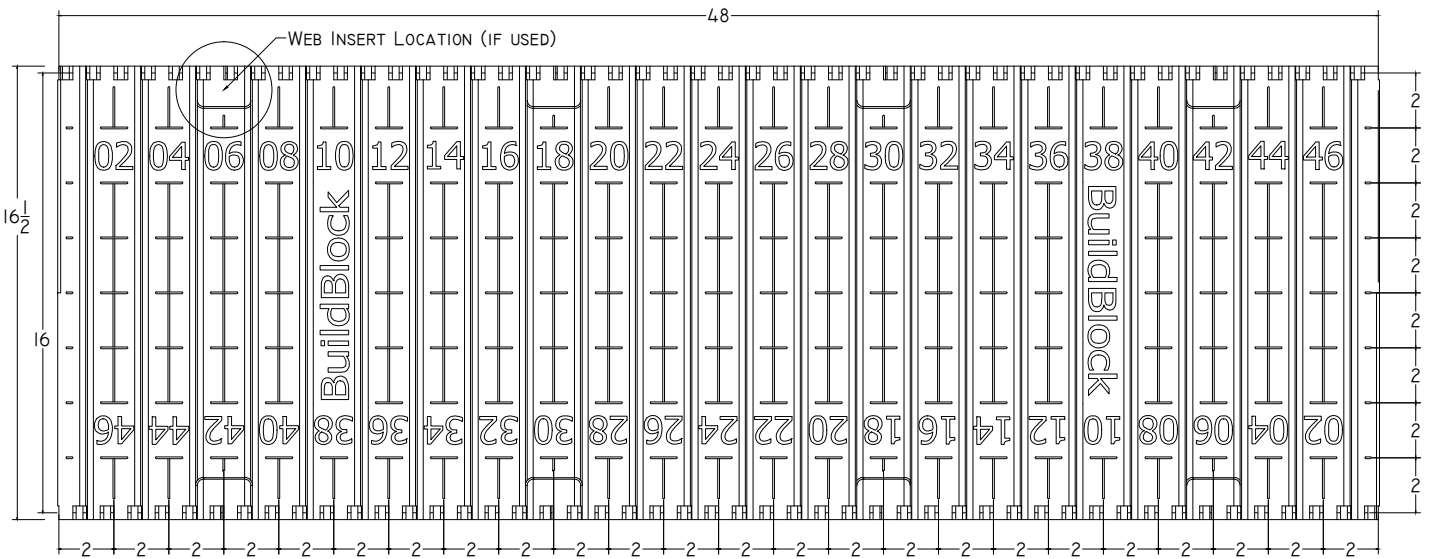

2 FRONT VIEW
SCALE: NTS

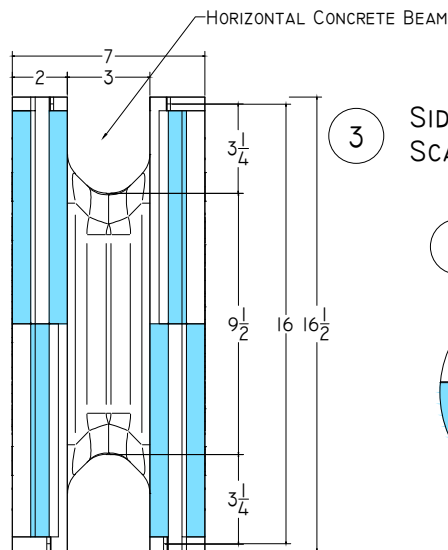

3 SIDE VIEW
SCALE: NTS

4 DOVETAIL DETAIL
SCALE: NTS

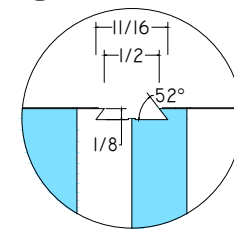

NOTE:
FORM IS REVERSIBLE, BOTH HORIZONTALLY AND VERTICALLY.
BLOCKS STACK @ 1'-4" (16") INCREMENTS.

LEGEND:
 = POSITIVE PROFILES (TONGUES)
 = NEGATIVE PROFILES (GROOVES)



GLOBALBLOCK ALL FOAM ICF 3" STRAIGHT BLOCK

DATE/REV 9/2015 SCALE NTS

DETAIL SHEET

NOTES

CONSTRUCTION SHALL BE IN ACCORDANCE WITH ALL APPLICABLE LOCAL AND NATIONAL CODES. ALL DRAWINGS ARE SUBJECT TO CHANGE WITHOUT NOTICE.

60A

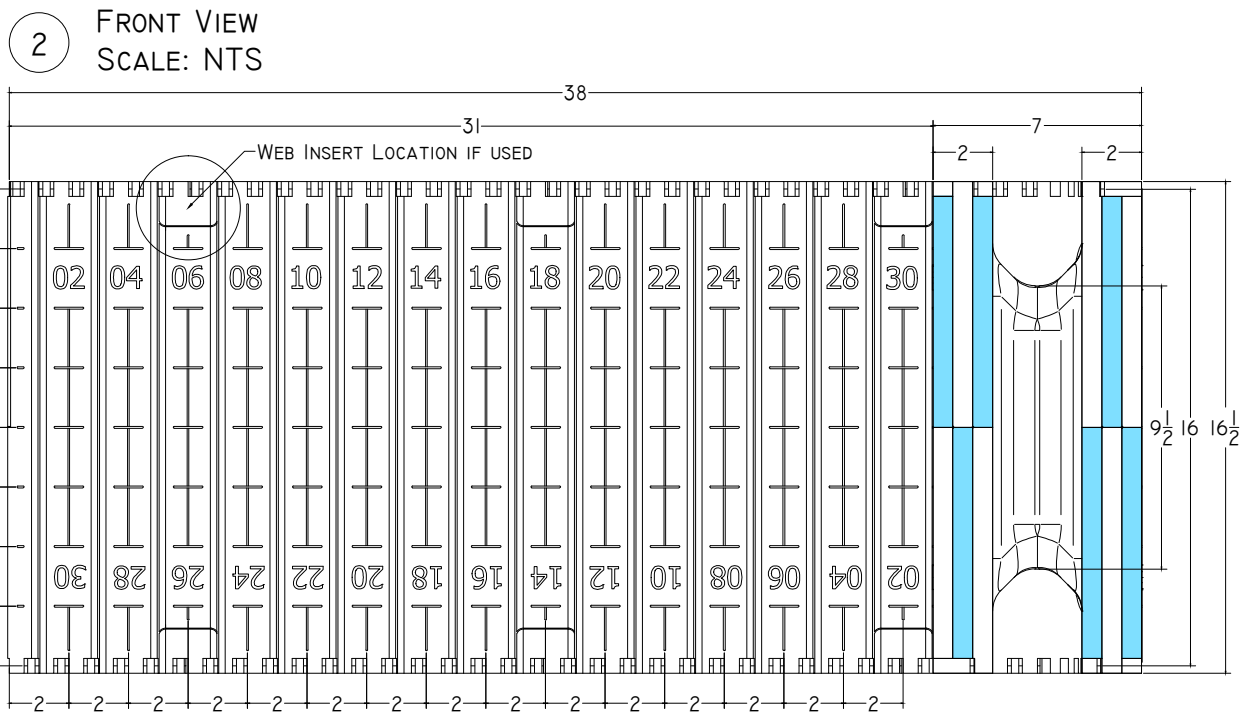
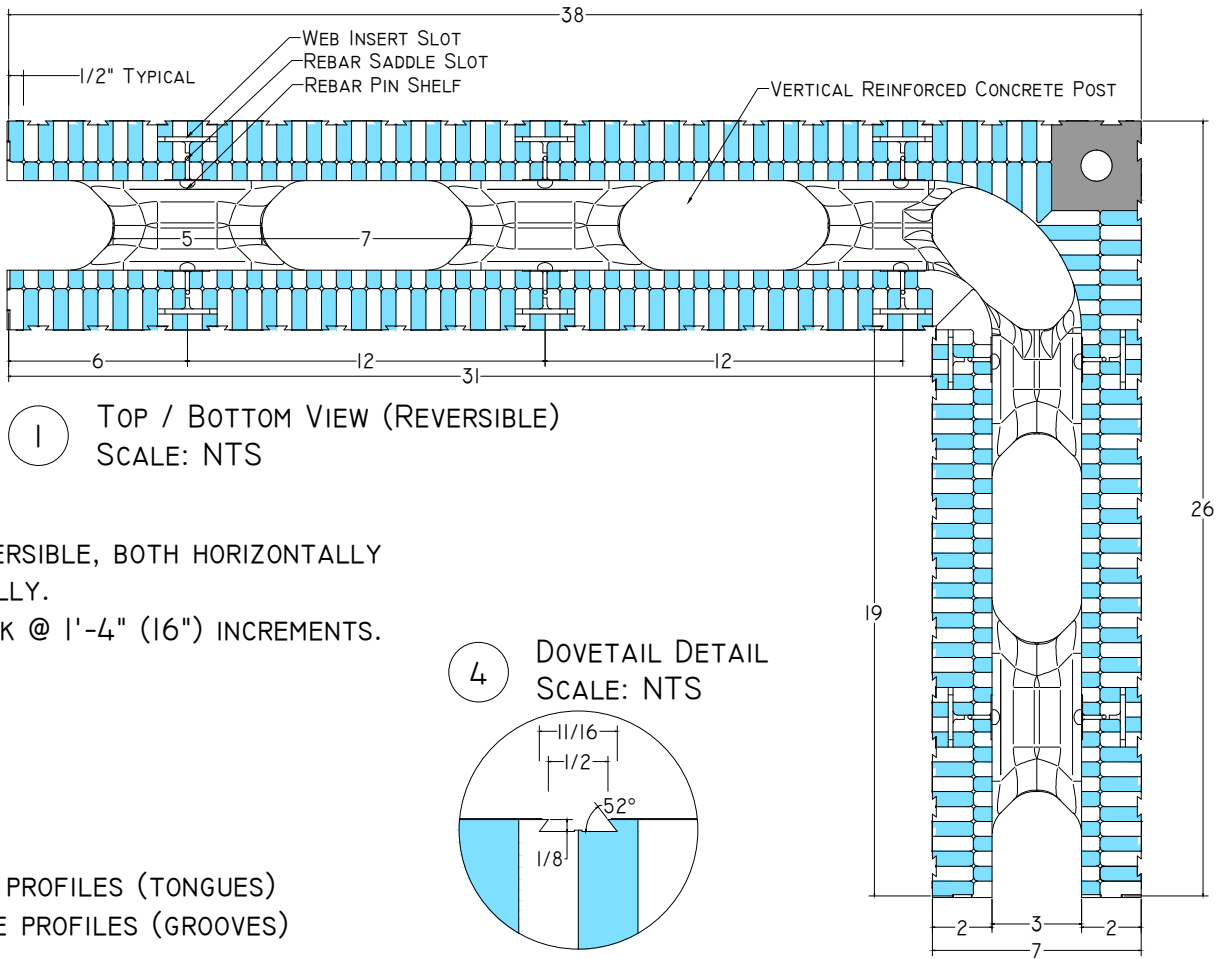

	GLOBALBLOCK ALL FOAM ICF 3" 90° CORNER BLOCK		
	DATE/REV 9/2015	SCALE NTS	DETAIL SHEET
OFFICE: 405-840-3386 TOLL FREE: 866-222-2575 FAX: 831-597-0792 BUILDBLOCK.COM			<p>CONSTRUCTION SHALL BE IN ACCORDANCE WITH ALL APPLICABLE LOCAL AND NATIONAL CODES. ALL DRAWINGS ARE SUBJECT TO CHANGE WITHOUT NOTICE.</p> <h1>60B</h1>

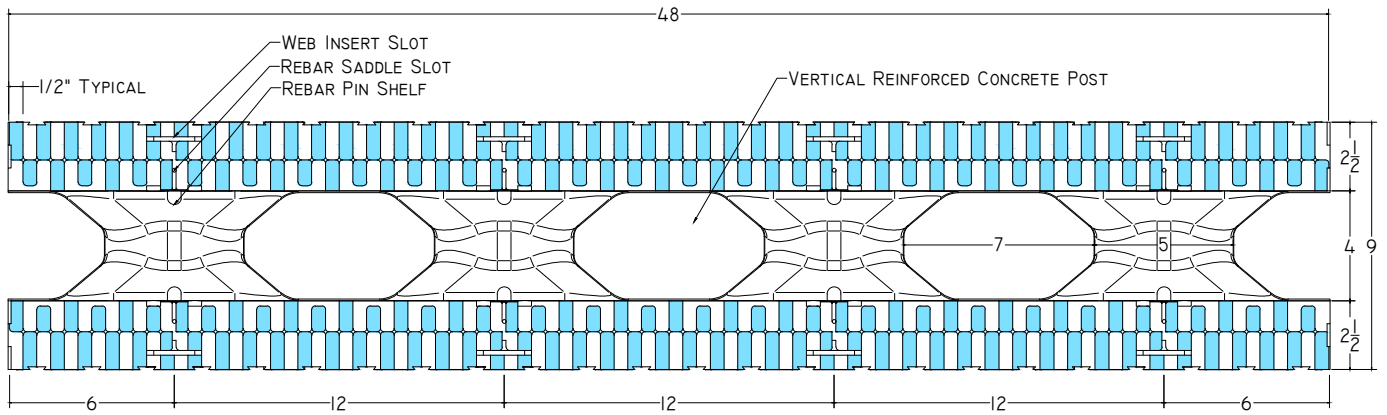

1 TOP / BOTTOM VIEW (REVERSIBLE)
SCALE: NTS

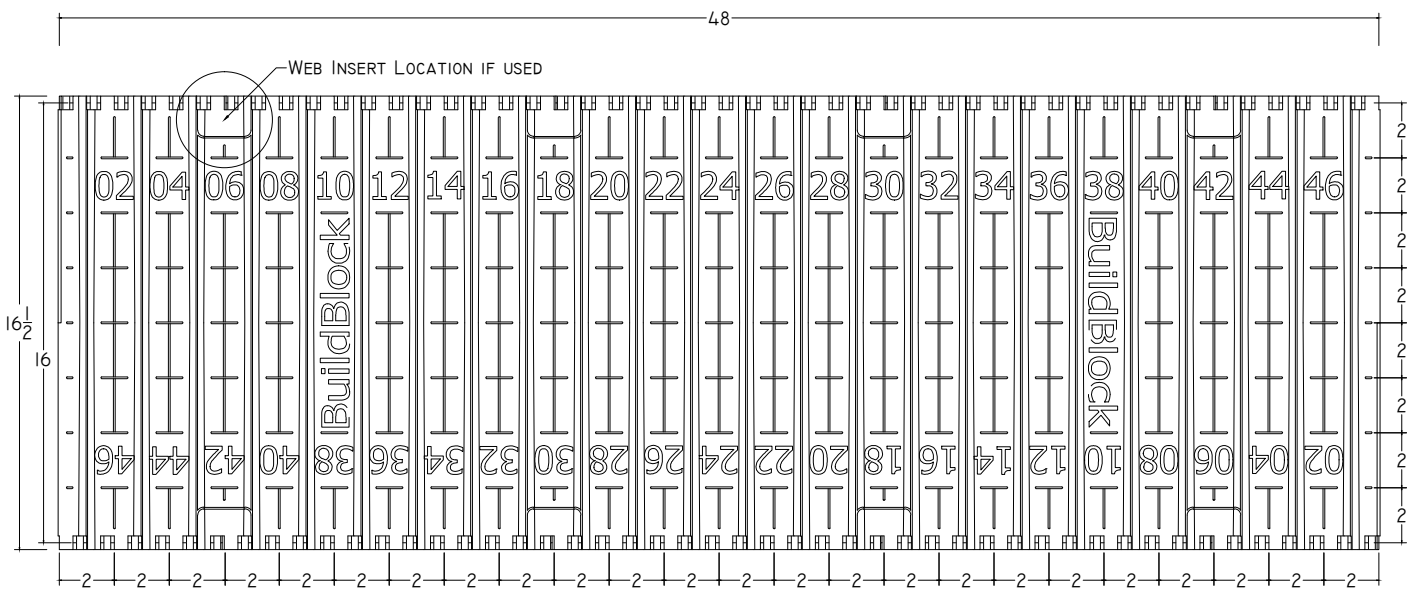

2 FRONT VIEW
SCALE: NTS

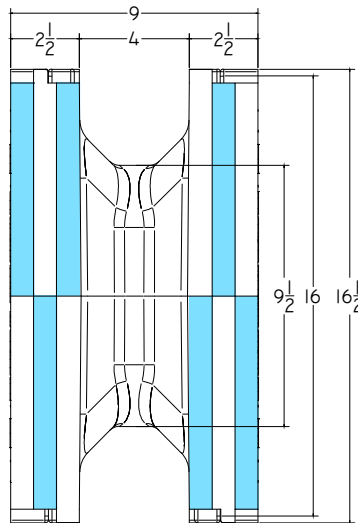

3 SIDE VIEW
SCALE: NTS

4 DOVETAIL DETAIL
SCALE: NTS

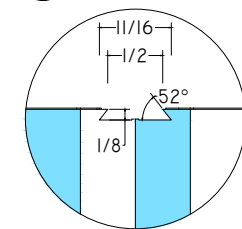

NOTE:
FORM IS REVERSIBLE, BOTH HORIZONTALLY
AND VERTICALLY.
BLOCKS STACK @ 1'-4" (16") INCREMENTS.

LEGEND:
■ = POSITIVE PROFILES (TONGUES)
□ = NEGATIVE PROFILES (GROOVES)



GLOBALBLOCK ALL FOAM ICF 4" STRAIGHT BLOCK

DATE/REV 9/2015 SCALE NTS

DETAIL SHEET

NOTES

CONSTRUCTION SHALL BE IN ACCORDANCE WITH ALL APPLICABLE
LOCAL AND NATIONAL CODES. ALL DRAWINGS ARE SUBJECT TO
CHANGE WITHOUT NOTICE.

60C

OFFICE: 405-840-3386 | TOLL FREE: 866-222-2575 | FAX: 831-597-0792
BUILDBLOCK.COM

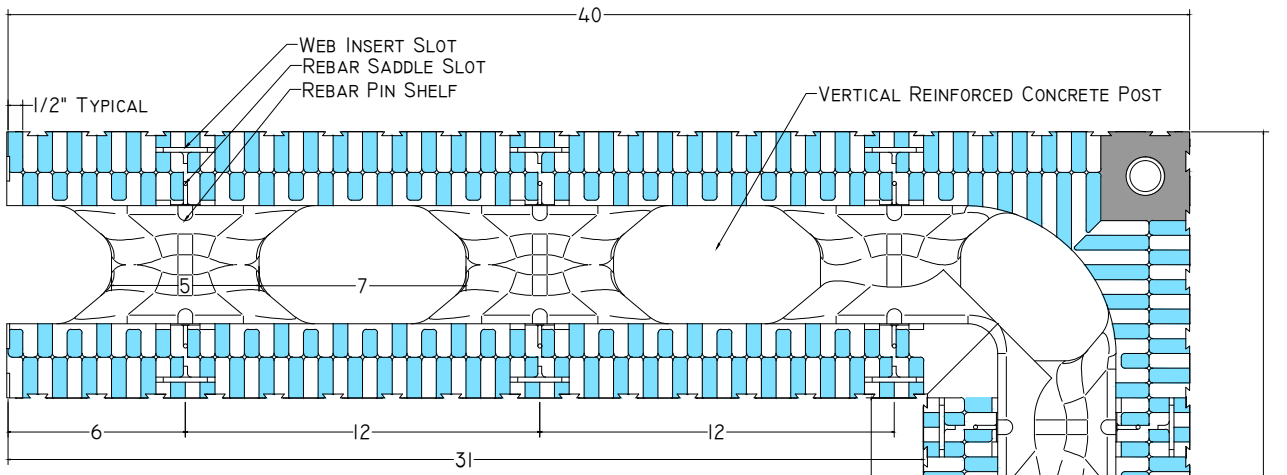

1 TOP / BOTTOM VIEW (REVERSIBLE)
SCALE: NTS

NOTE:
FORM IS REVERSIBLE, BOTH HORIZONTALLY
AND VERTICALLY.
BLOCKS STACK @ 1'-4" (16") INCREMENTS.

4 DOVETAIL DETAIL
SCALE: NTS

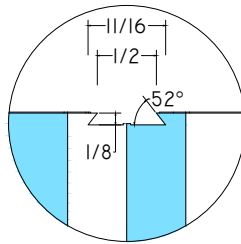

LEGEND:

- = POSITIVE PROFILES (TONGUES)
- = NEGATIVE PROFILES (GROOVES)

2 FRONT VIEW
SCALE: NTS

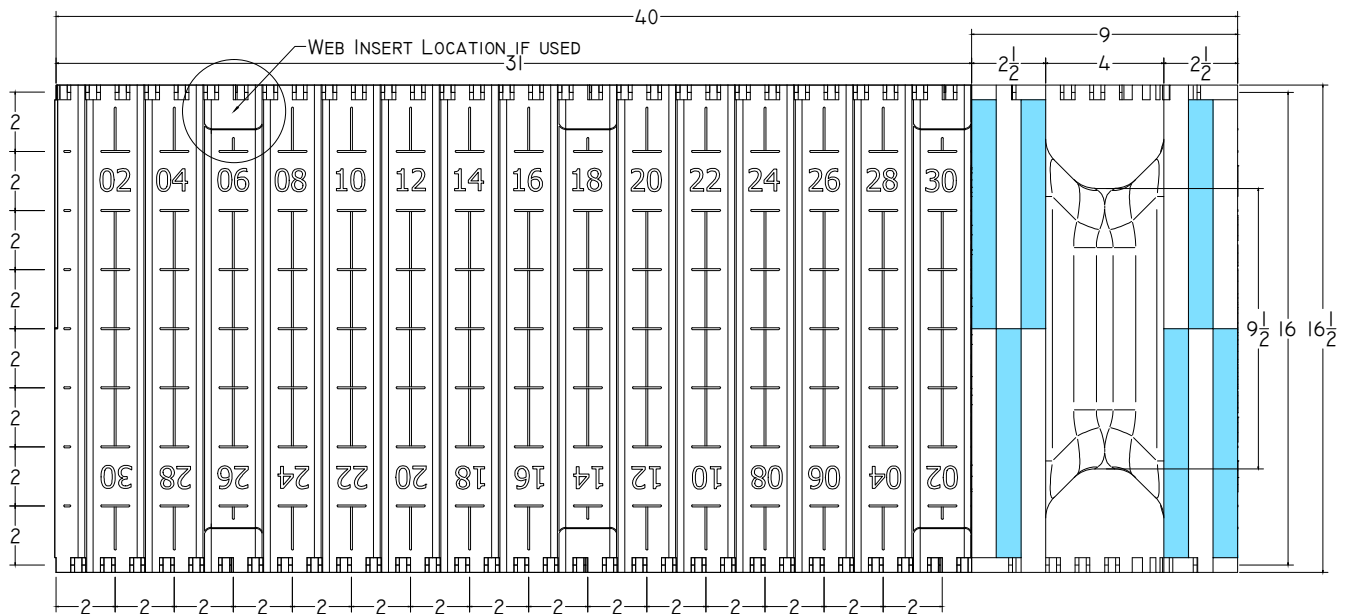

GLOBALBLOCK ALL FOAM ICF 4" 90° CORNER BLOCK

DATE/REV 9/2015

SCALE NTS

DETAIL SHEET

NOTES

CONSTRUCTION SHALL BE IN ACCORDANCE WITH ALL APPLICABLE
LOCAL AND NATIONAL CODES. ALL DRAWINGS ARE SUBJECT TO
CHANGE WITHOUT NOTICE.

60D

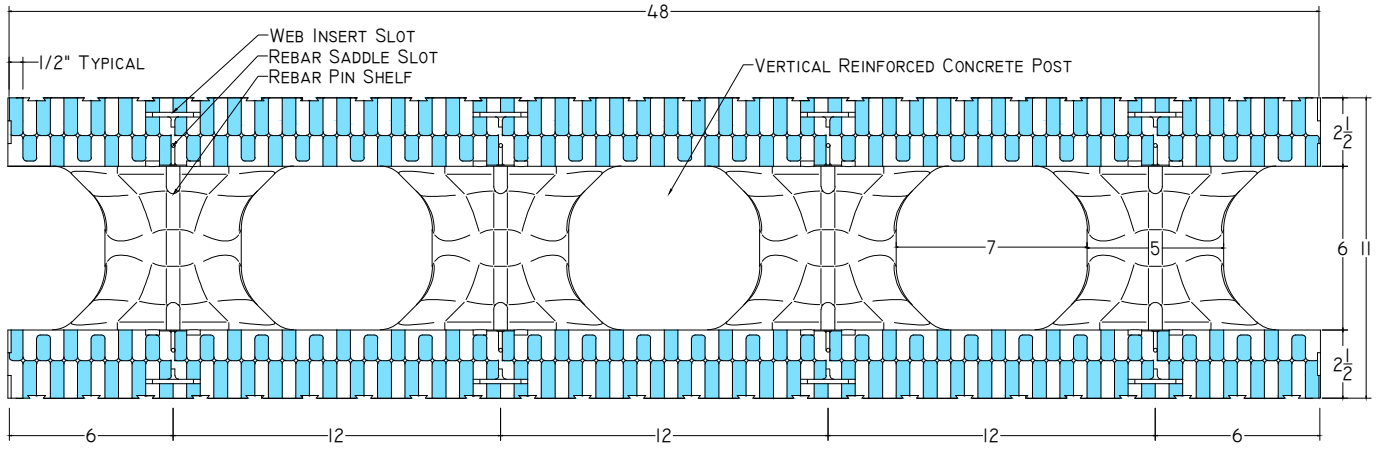

1 TOP / BOTTOM VIEW (REVERSIBLE)
SCALE: NTS

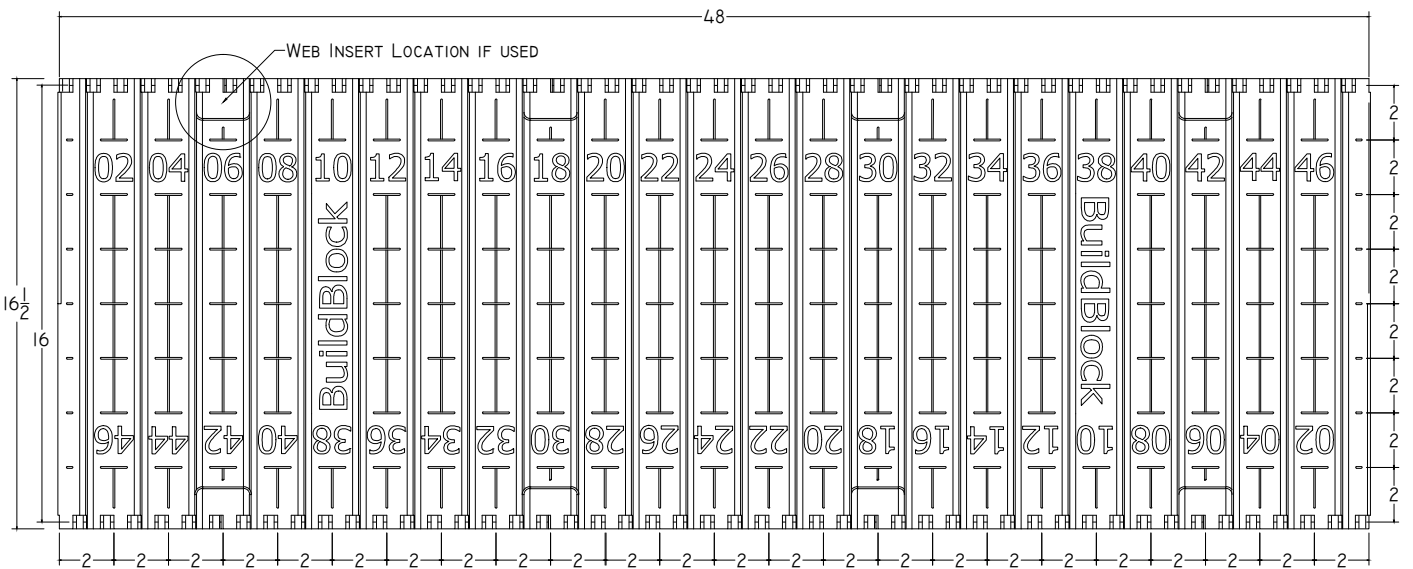

2 FRONT VIEW
SCALE: NTS

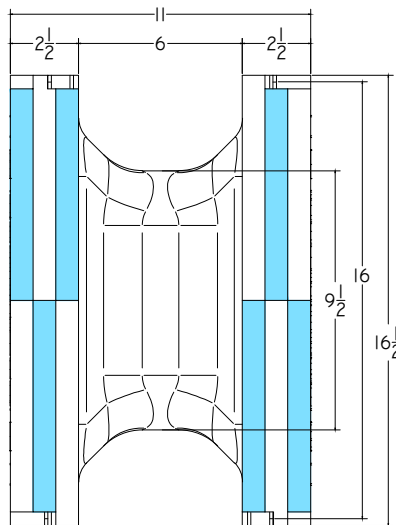

3 SIDE VIEW
SCALE: NTS

4 DOVETAIL DETAIL
SCALE: NTS

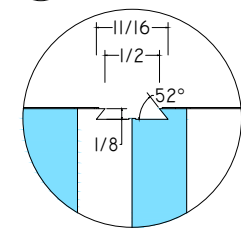

NOTE:
FORM IS REVERSIBLE, BOTH HORIZONTALLY AND VERTICALLY.
BLOCKS STACK @ 1'-4" (16") INCREMENTS.

LEGEND:
■ = POSITIVE PROFILES (TONGUES)
□ = NEGATIVE PROFILES (GROOVES)



GLOBALBLOCK ALL FOAM ICF 6" STRAIGHT BLOCK

DATE/REV 9/2015 SCALE NTS

DETAIL SHEET

NOTES

CONSTRUCTION SHALL BE IN ACCORDANCE WITH ALL APPLICABLE LOCAL AND NATIONAL CODES. ALL DRAWINGS ARE SUBJECT TO CHANGE WITHOUT NOTICE.

60E

OFFICE: 405-840-3386 | TOLL FREE: 866-222-2575 | FAX: 831-597-0792
BUILDBLOCK.COM

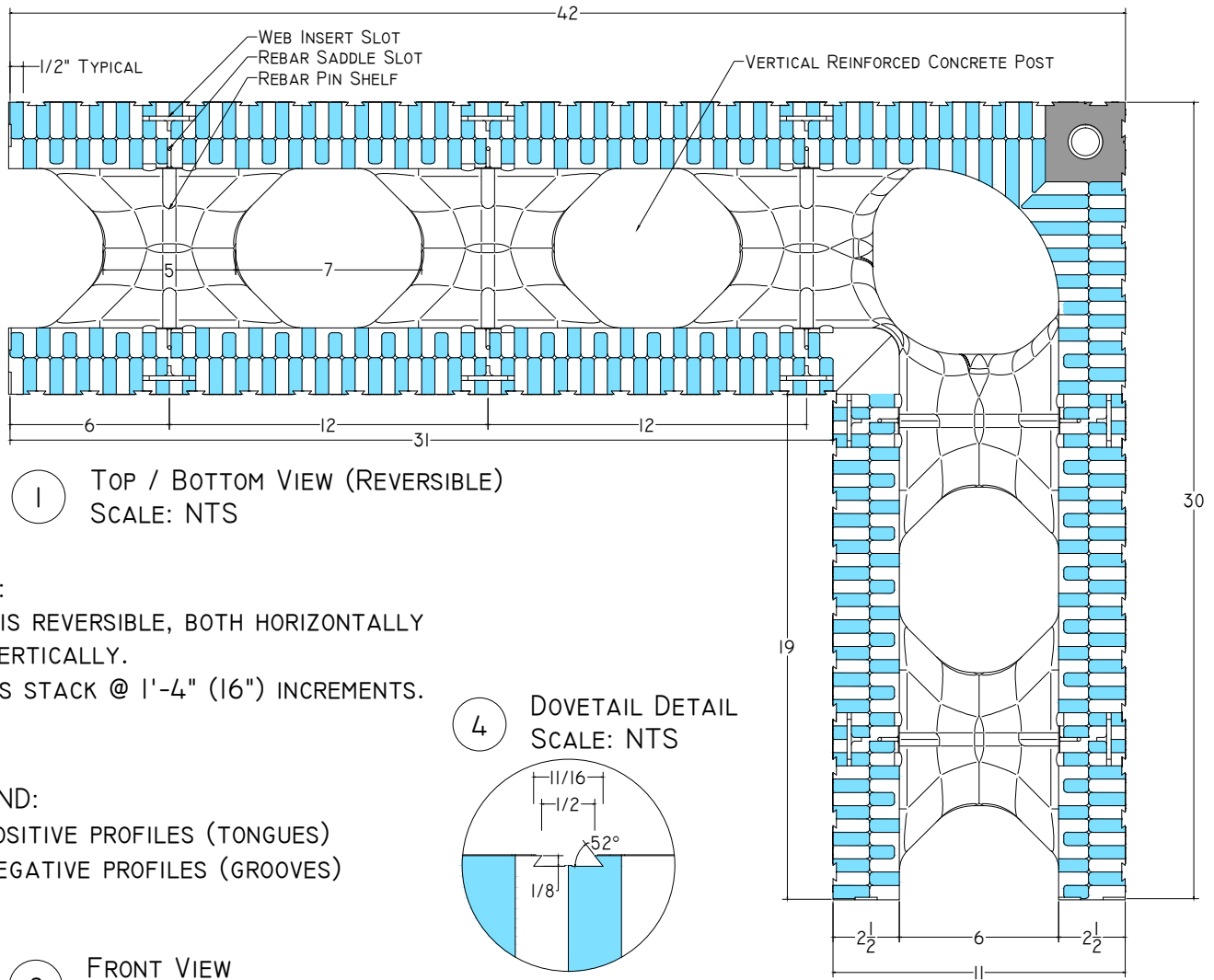

1 TOP / BOTTOM VIEW (REVERSIBLE)
SCALE: NTS

NOTE:
FORM IS REVERSIBLE, BOTH HORIZONTALLY
AND VERTICALLY.
BLOCKS STACK @ 1'-4" (16") INCREMENTS.

4 DOVETAIL DETAIL
SCALE: NTS

LEGEND:

- = POSITIVE PROFILES (TONGUES)
- = NEGATIVE PROFILES (GROOVES)

2 FRONT VIEW
SCALE: NTS

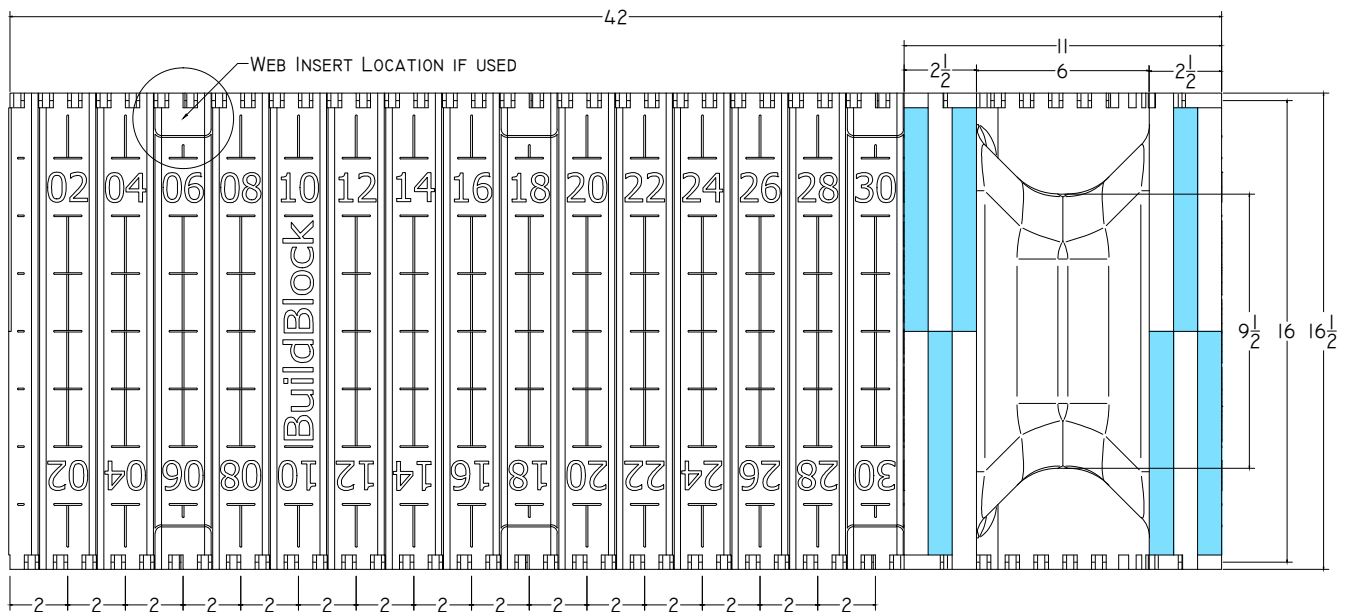

<p>BuildBlock BUILDING SYSTEMS</p>	GLOBALBLOCK ALL FOAM ICF 6" 90° CORNER BLOCK		DETAIL SHEET
	DATE/REV	9/2015	SCALE
NOTES		60F	
<p>CONSTRUCTION SHALL BE IN ACCORDANCE WITH ALL APPLICABLE LOCAL AND NATIONAL CODES. ALL DRAWINGS ARE SUBJECT TO CHANGE WITHOUT NOTICE.</p>			
<p>OFFICE: 405-840-3386 TOLL FREE: 866-222-2575 FAX: 831-597-0792 BUILDBLOCK.COM</p>			

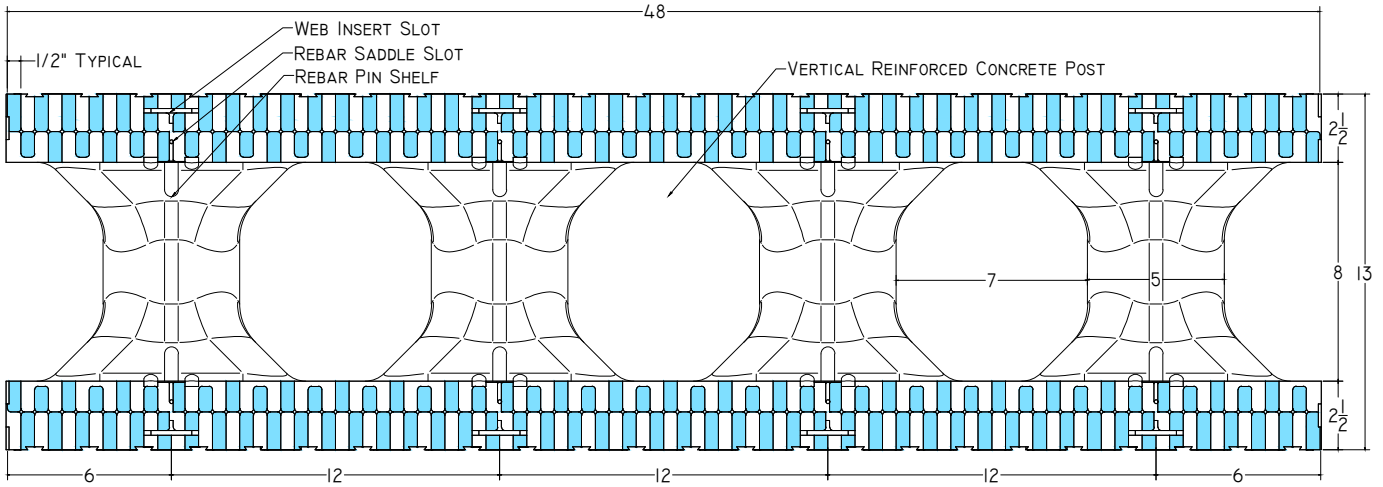

1 TOP / BOTTOM VIEW (REVERSIBLE)
SCALE: NTS

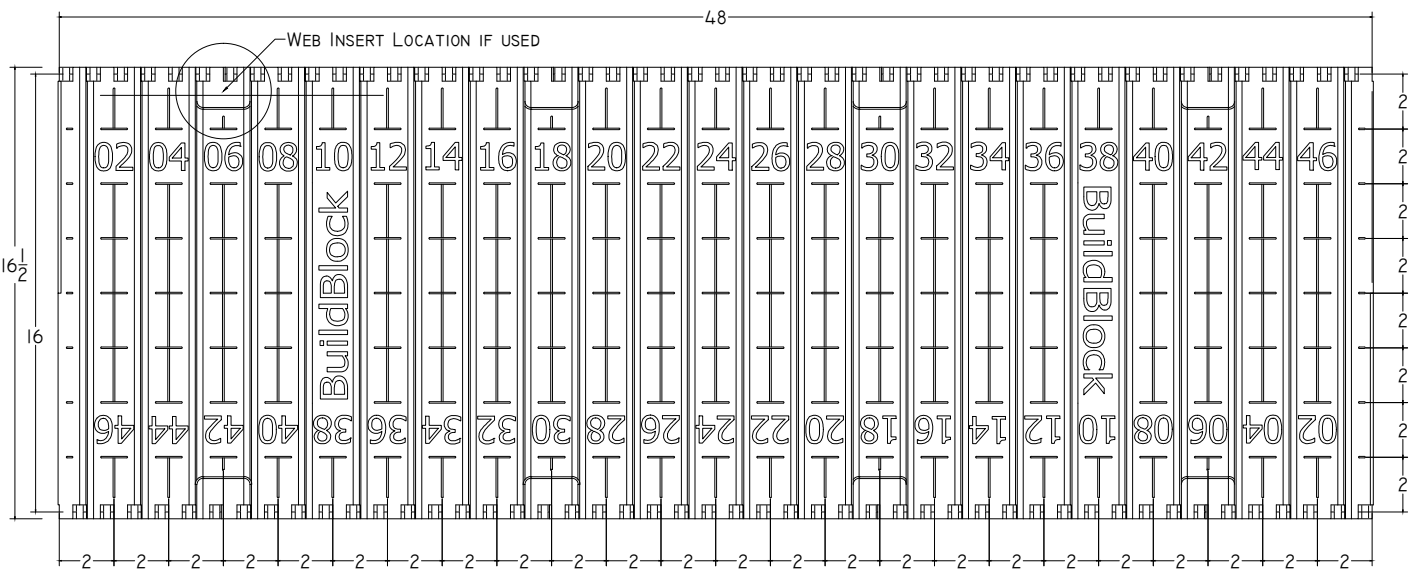

2 FRONT VIEW
SCALE: NTS

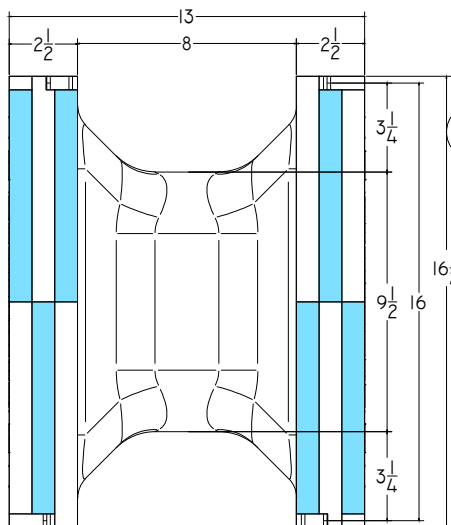

3 SIDE VIEW
SCALE: NTS

4 DOVETAIL DETAIL
SCALE: NTS

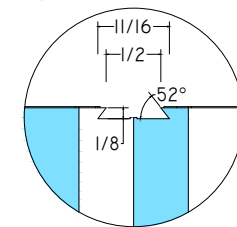

NOTE:
FORM IS REVERSIBLE, BOTH HORIZONTALLY AND VERTICALLY.
BLOCKS STACK @ 1'-4" (16") INCREMENTS.

LEGEND:
 = POSITIVE PROFILES (TONGUES)
 = NEGATIVE PROFILES (GROOVES)



GLOBALBLOCK ALL FOAM ICF 8" STRAIGHT BLOCK

DATE/REV 9/2015 SCALE NTS

DETAIL SHEET

NOTES

OFFICE: 405-840-3386 | TOLL FREE: 866-222-2575 | FAX: 831-597-0792
BUILDBLOCK.COM

CONSTRUCTION SHALL BE IN ACCORDANCE WITH ALL APPLICABLE LOCAL AND NATIONAL CODES. ALL DRAWINGS ARE SUBJECT TO CHANGE WITHOUT NOTICE.

60G

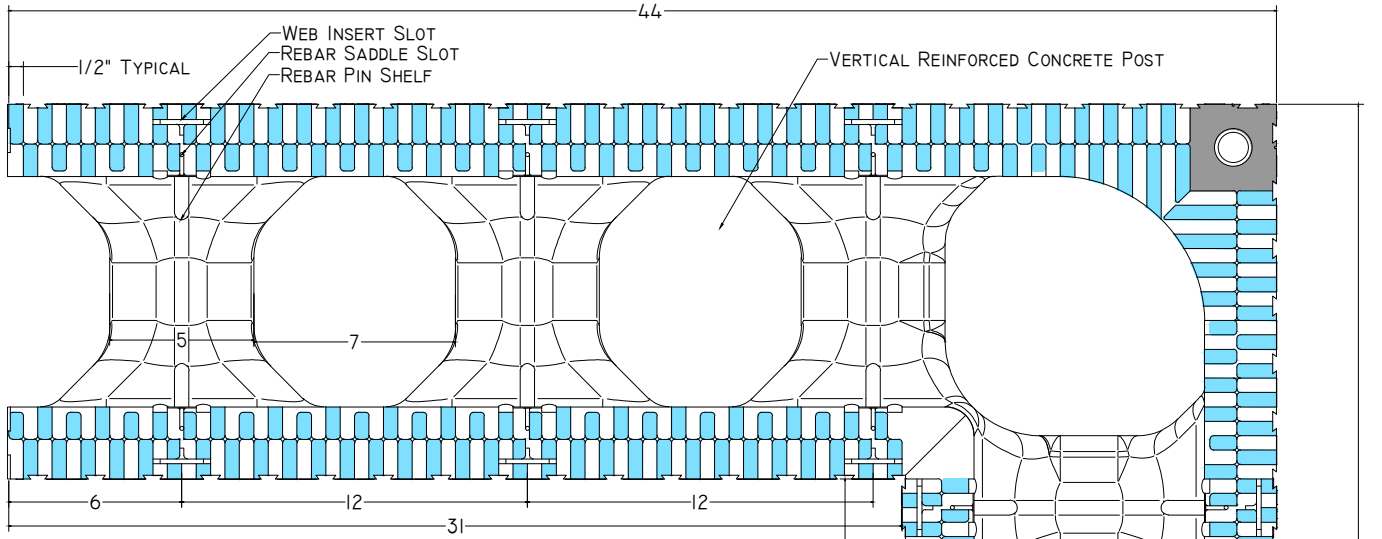

1 TOP / BOTTOM VIEW (REVERSIBLE)
SCALE: NTS

NOTE:
FORM IS REVERSIBLE, BOTH HORIZONTALLY
AND VERTICALLY.
BLOCKS STACK @ 1'-4" (16") INCREMENTS.

4 DOVETAIL DETAIL
SCALE: NTS

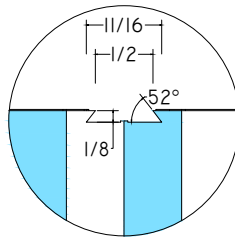

LEGEND:

- = POSITIVE PROFILES (TONGUES)
- = NEGATIVE PROFILES (GROOVES)

2 FRONT VIEW
SCALE: NTS

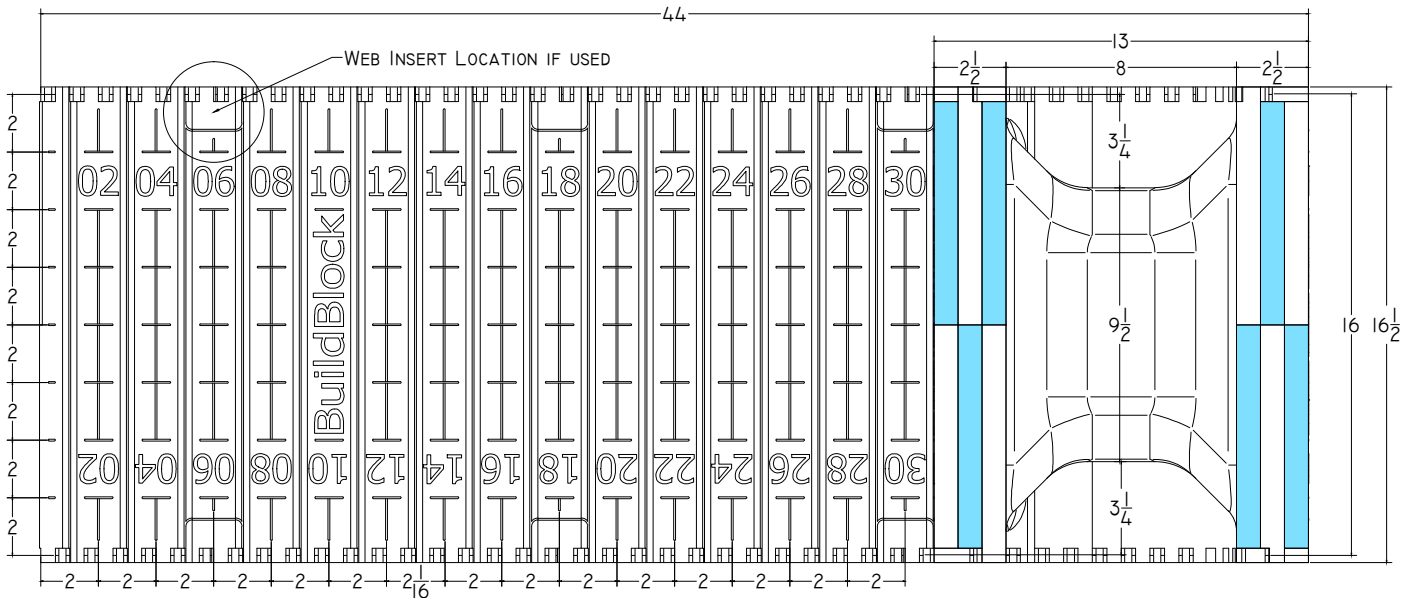

GLOBALBLOCK ALL FOAM ICF 8" 90° CORNER BLOCK

DATE/REV	9/2015	SCALE	NTS
----------	--------	-------	-----

NOTES	DETAIL SHEET
-------	--------------

OFFICE: 405-840-3386 | TOLL FREE: 866-222-2575 | FAX: 831-597-0792
BUILDBLOCK.COM

CONSTRUCTION SHALL BE IN ACCORDANCE WITH ALL APPLICABLE
LOCAL AND NATIONAL CODES. ALL DRAWINGS ARE SUBJECT TO
CHANGE WITHOUT NOTICE.

60H

GLOBALBLOCK WEB INSERTS

GLOBALBLOCK STARTER INSERTS

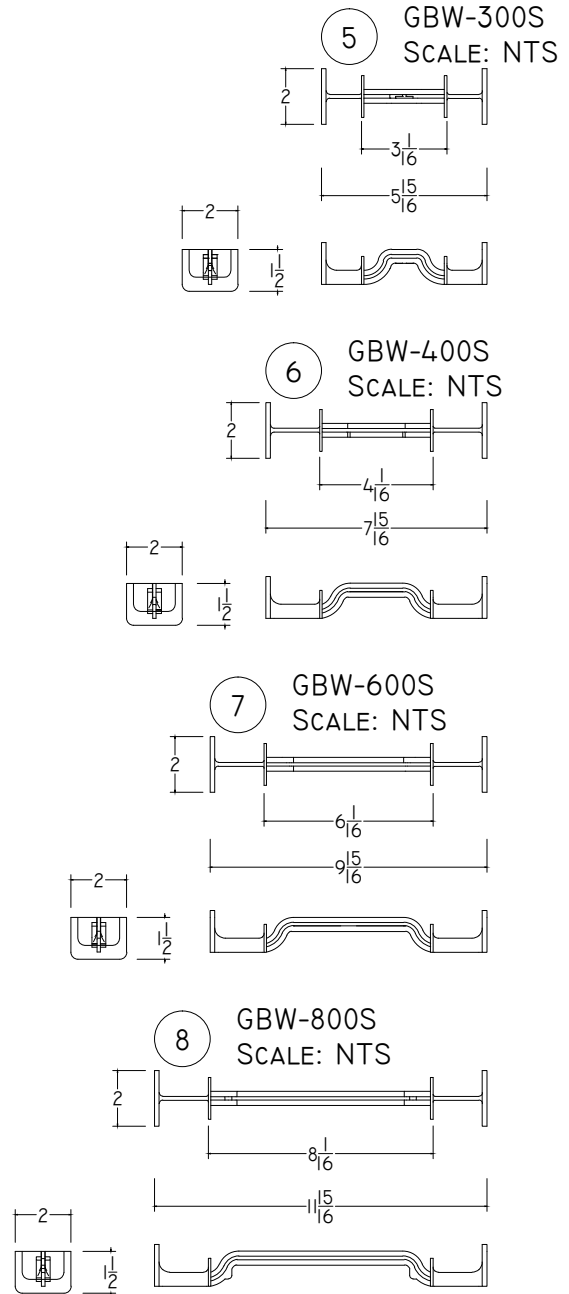
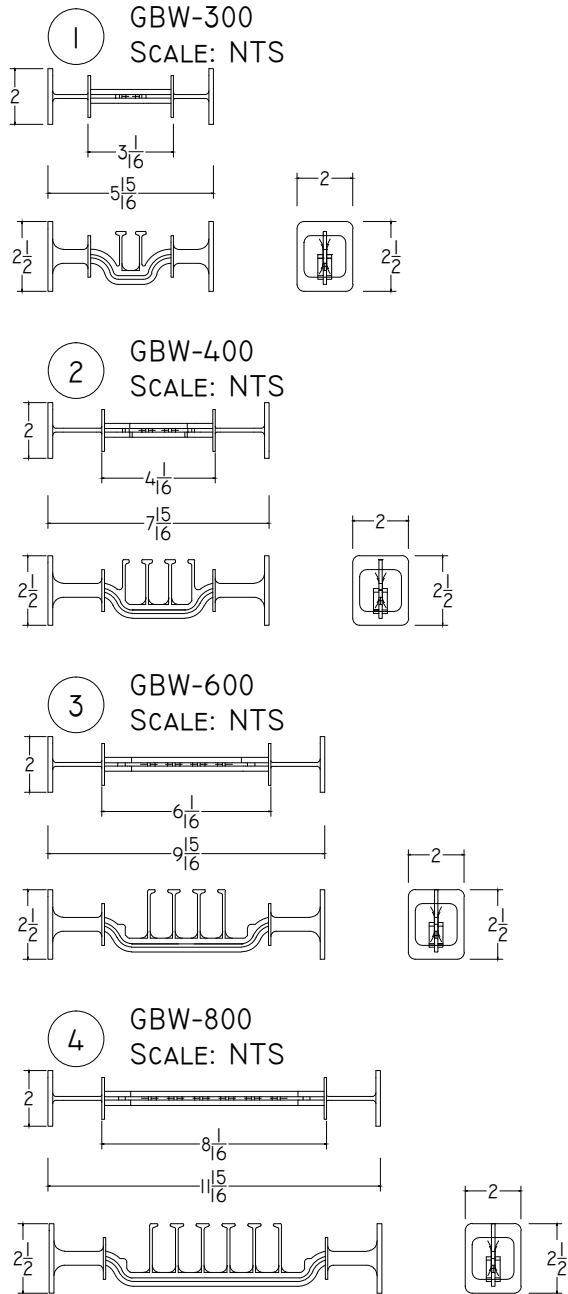

	GLOBALBLOCK WEB INSERTS DETAIL			DETAIL SHEET
	DATE/REV	9/2015	SCALE	NTS
NOTES	CONSTRUCTION SHALL BE IN ACCORDANCE WITH ALL APPLICABLE LOCAL AND NATIONAL CODES. ALL DRAWINGS ARE SUBJECT TO CHANGE WITHOUT NOTICE.			<h1>601</h1>
OFFICE: 405-840-3386 TOLL FREE: 866-222-2575 FAX: 831-597-0792 BUILDBLOCK.COM				

GLOBALBLOCK REBAR SADDLES

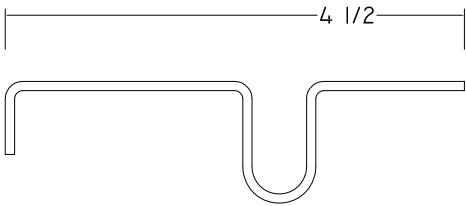

SLOT TO HOLD UP TO
(2) #4 BARS

① GB-300RS
SCALE: NTS

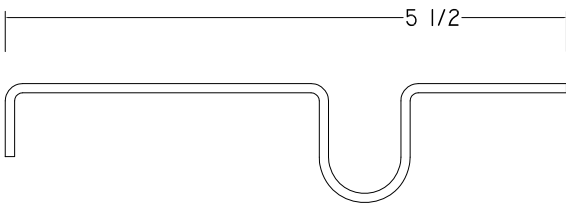

SLOT TO HOLD UP TO
(2) #5 BARS

② GBW-400RS
SCALE: NTS

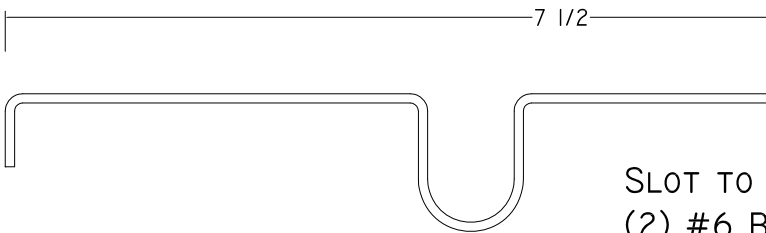

SLOT TO HOLD UP TO
(2) #6 BARS

③ GBW-600RS
SCALE: NTS

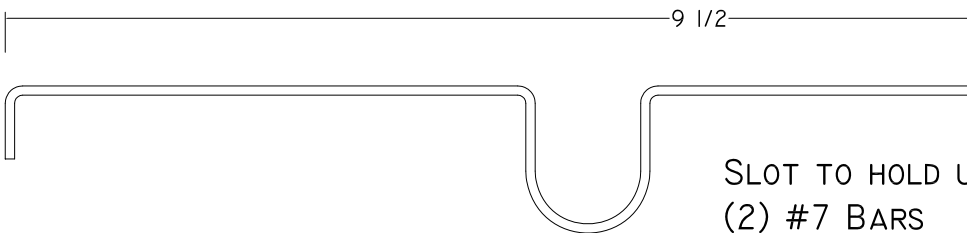

SLOT TO HOLD UP TO
(2) #7 BARS

④ GBW-800RS
SCALE: NTS

 <p>OFFICE: 405-840-3386 TOLL FREE: 866-222-2575 FAX: 831-597-0792 BUILDBLOCK.COM</p>	GLOBALBLOCK REBAR SADDLE DETAIL			DETAIL SHEET
	DATE/REV	9/2015	SCALE	NTS
	NOTES	CONSTRUCTION SHALL BE IN ACCORDANCE WITH ALL APPLICABLE LOCAL AND NATIONAL CODES. ALL DRAWINGS ARE SUBJECT TO CHANGE WITHOUT NOTICE.		
				60J

M REBAR PINS
SCALE: NTS

N REBAR SADDLES
SCALE: NTS

L WEB INSERTS
SCALE: NTS

GLOBALBLOCK REINFORCEMENT OPTIONS:
SEE INDIVIDUAL DETAILS FOR PLACEMENT AND
NOTES.

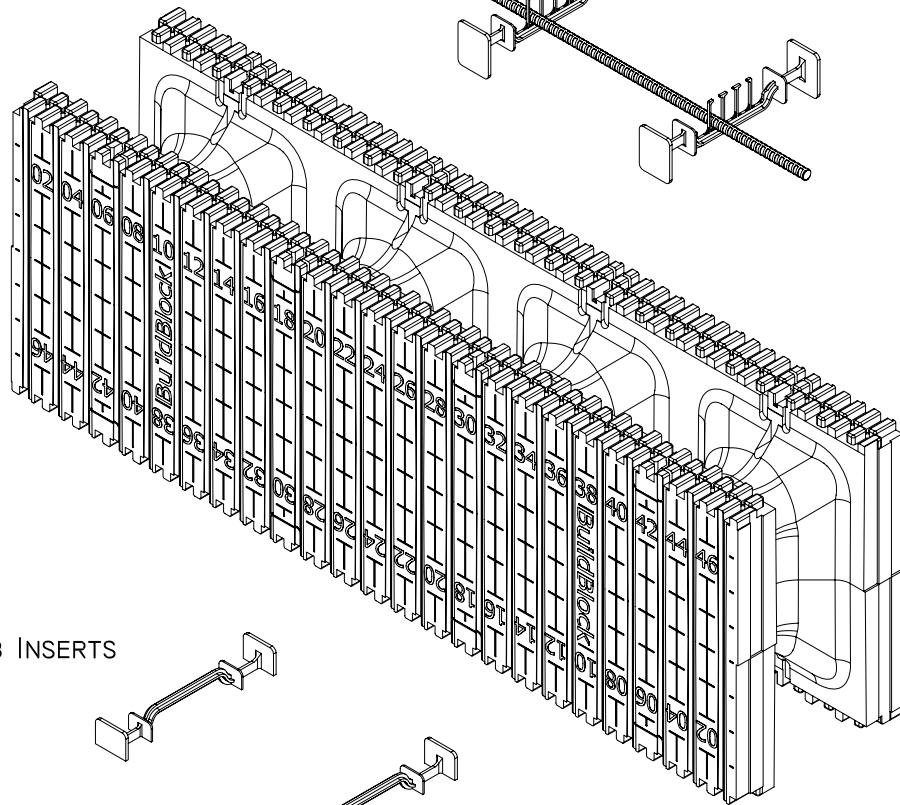

L STARTER WEB INSERTS
SCALE: NTS

REBAR PINS ARE REQUIRED FOR THE TOP COURSE TO ENSURE ADEQUATE CONCRETE COVER FOR TOP HORIZONTAL REINFORCEMENT. WIRE TIES ARE REQUIRED ON THIS COURSE TO MAINTAIN PLACEMENT OF HORIZONTAL AND VERTICAL REINFORCEMENT.

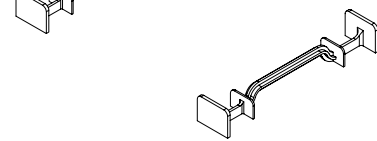

	GLOBALBLOCK COMBINED REINFORCEMENT OPTIONS				
	DATE/REV	9/2015	SCALE	NTS	DETAIL SHEET
	NOTES				60K
OFFICE: 405-840-3386 TOLL FREE: 866-222-2575 FAX: 831-597-0792 BUILDBLOCK.COM	CONSTRUCTION SHALL BE IN ACCORDANCE WITH ALL APPLICABLE LOCAL AND NATIONAL CODES. ALL DRAWINGS ARE SUBJECT TO CHANGE WITHOUT NOTICE.				

WEB INSERTS PROVIDE REBAR SUPPORT AND WALL FINISH ATTACHMENT POINTS FOR GLOBALBLOCK ICF WALLS.
 WEB INSERTS ARE PLACED INTO THE MOLDED SLOTS DURING STACKING. ALTERNATE REBAR POSITIONS EACH COURSE TO CREATE A CHASE FOR VERTICAL STEEL REINFORCEMENT, PLACED AFTER STACKING, PER ENGINEERING GUIDELINES.

OPTIONAL:
 WHEN NOT USING WEB INSERTS AS ATTACHMENT POINTS, IT IS PERMISSABLE TO USE ONLY 2 INSERTS PER FORM FOR STEEL REINFORCEMENT.
 IT IS RECOMMENDED TO SPACE EVENLY, EVERY OTHER SLOT.

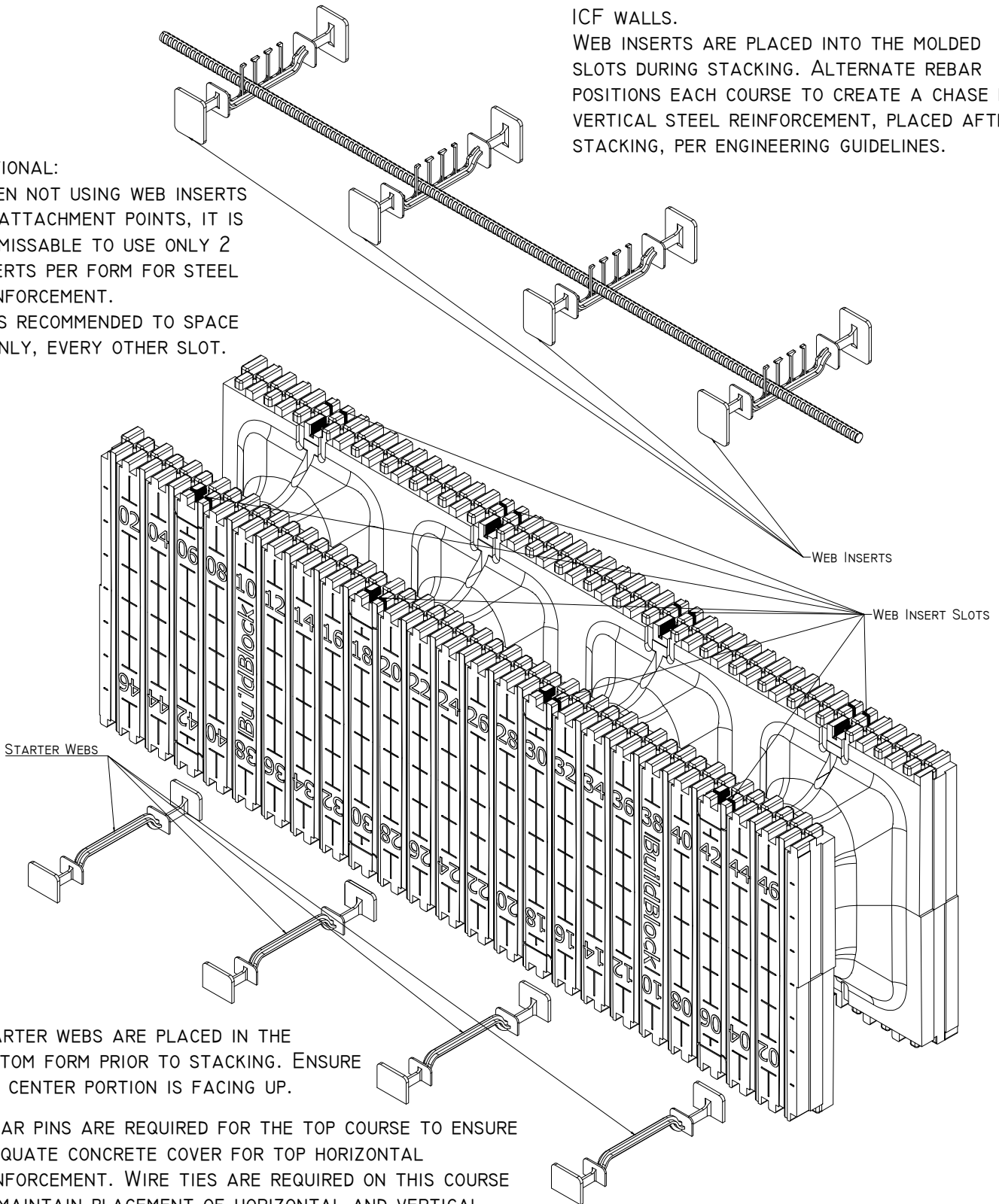

STARTER WEBS ARE PLACED IN THE BOTTOM FORM PRIOR TO STACKING. ENSURE THE CENTER PORTION IS FACING UP.

REBAR PINS ARE REQUIRED FOR THE TOP COURSE TO ENSURE ADEQUATE CONCRETE COVER FOR TOP HORIZONTAL REINFORCEMENT. WIRE TIES ARE REQUIRED ON THIS COURSE TO MAINTAIN PLACEMENT OF HORIZONTAL AND VERTICAL REINFORCEMENT.



GLOBALBLOCK USING PLASTIC WEB INSERTS

DATE/REV	9/2015	SCALE	NTS	DETAIL SHEET
----------	--------	-------	-----	--------------

NOTES	
-------	--

OFFICE: 405-840-3386 | TOLL FREE: 866-222-2575 | FAX: 831-597-0792
 BUILDBLOCK.COM

CONSTRUCTION SHALL BE IN ACCORDANCE WITH ALL APPLICABLE LOCAL AND NATIONAL CODES. ALL DRAWINGS ARE SUBJECT TO CHANGE WITHOUT NOTICE.

60L

REBAR PINS ARE THE SIMPLEST MEANS OF SUPPORTING HORIZONTAL REBAR IN GLOBALBLOCK ICFs. #3 OR #4 PINS ARE CUT TO LENGTH (1/4" LESS THAN NOMINAL FORM WIDTH) AND PLACED INTO THE MOLDED SLOTS. THE HORIZONTAL BARS ARE THEN PLACED DIRECTLY ONTO THE PINS. WIRE TIES ARE REQUIRED TO MAINTAIN PLACEMENT OF HORIZONTAL AND VERTICAL REINFORCEMENT.

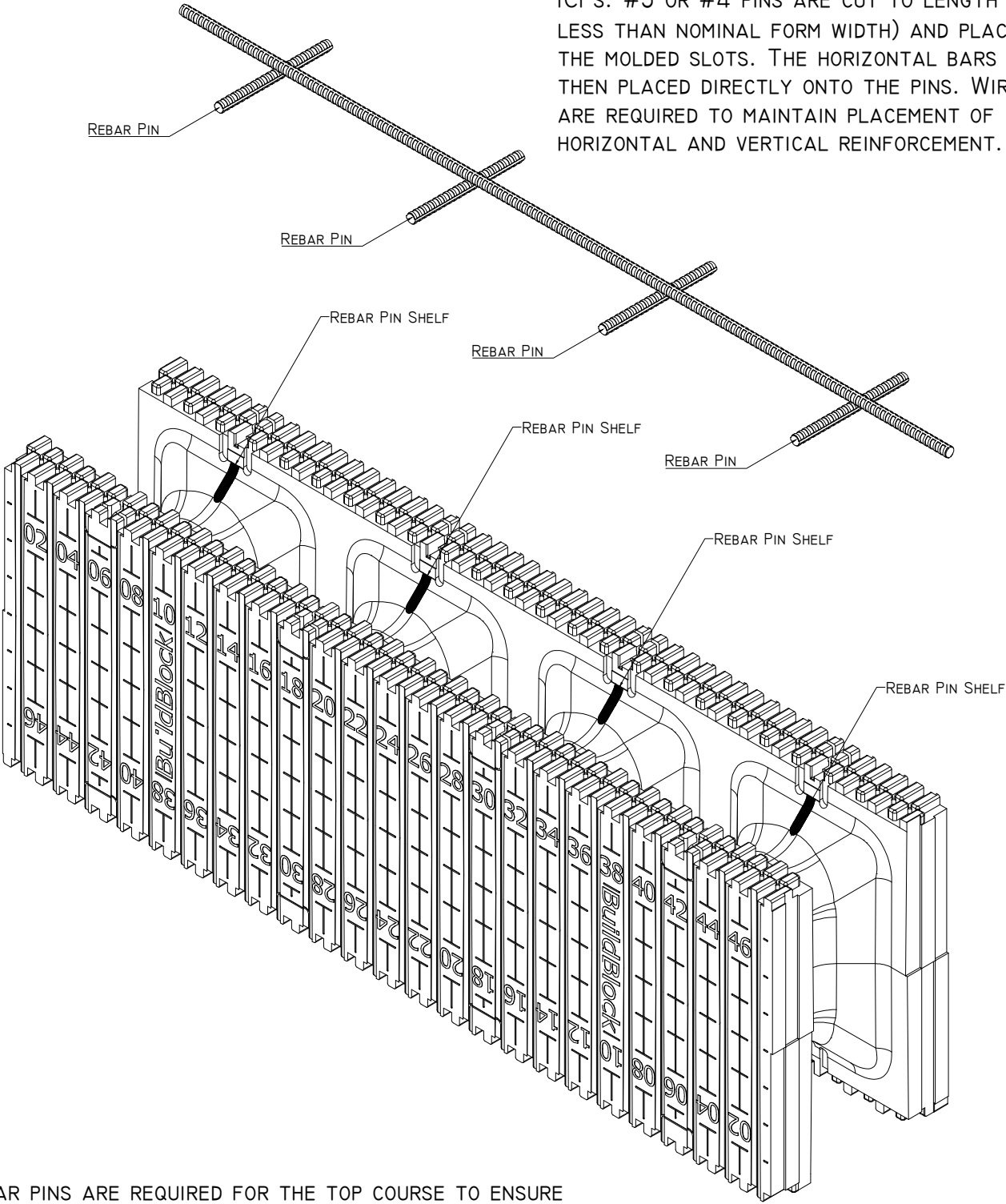

REBAR PINS ARE REQUIRED FOR THE TOP COURSE TO ENSURE ADEQUATE CONCRETE COVER FOR TOP HORIZONTAL REINFORCEMENT. WIRE TIES ARE REQUIRED ON THIS COURSE TO MAINTAIN PLACEMENT OF HORIZONTAL AND VERTICAL REINFORCEMENT.

	GLOBALBLOCK USING REBAR PINS			DETAIL SHEET
	DATE/REV	9/2015	SCALE	NTS
	NOTES			
OFFICE: 405-840-3386 TOLL FREE: 866-222-2575 FAX: 831-597-0792 BUILDBLOCK.COM	CONSTRUCTION SHALL BE IN ACCORDANCE WITH ALL APPLICABLE LOCAL AND NATIONAL CODES. ALL DRAWINGS ARE SUBJECT TO CHANGE WITHOUT NOTICE.			60M

GLOBALBLOCK REBAR SADDLES PROVIDE A SIMPLE MEANS OF SUPPORTING REBAR, WITHOUT TIES, NEAR THE CENTER OF THE BEAM, WHILE ALSO PERMITTING THE BARS TO BE OFFSET STACKED TO CREATE A CHASE FOR VERTICAL STEEL. USE SADDLES WHEN FINISHING THE WALL WITH BUILDCRETE STUCCO OR PLASTER, OR WHERE MECHANICAL ATTACHMENT IS NOT REQUIRED FOR THE FINISH.

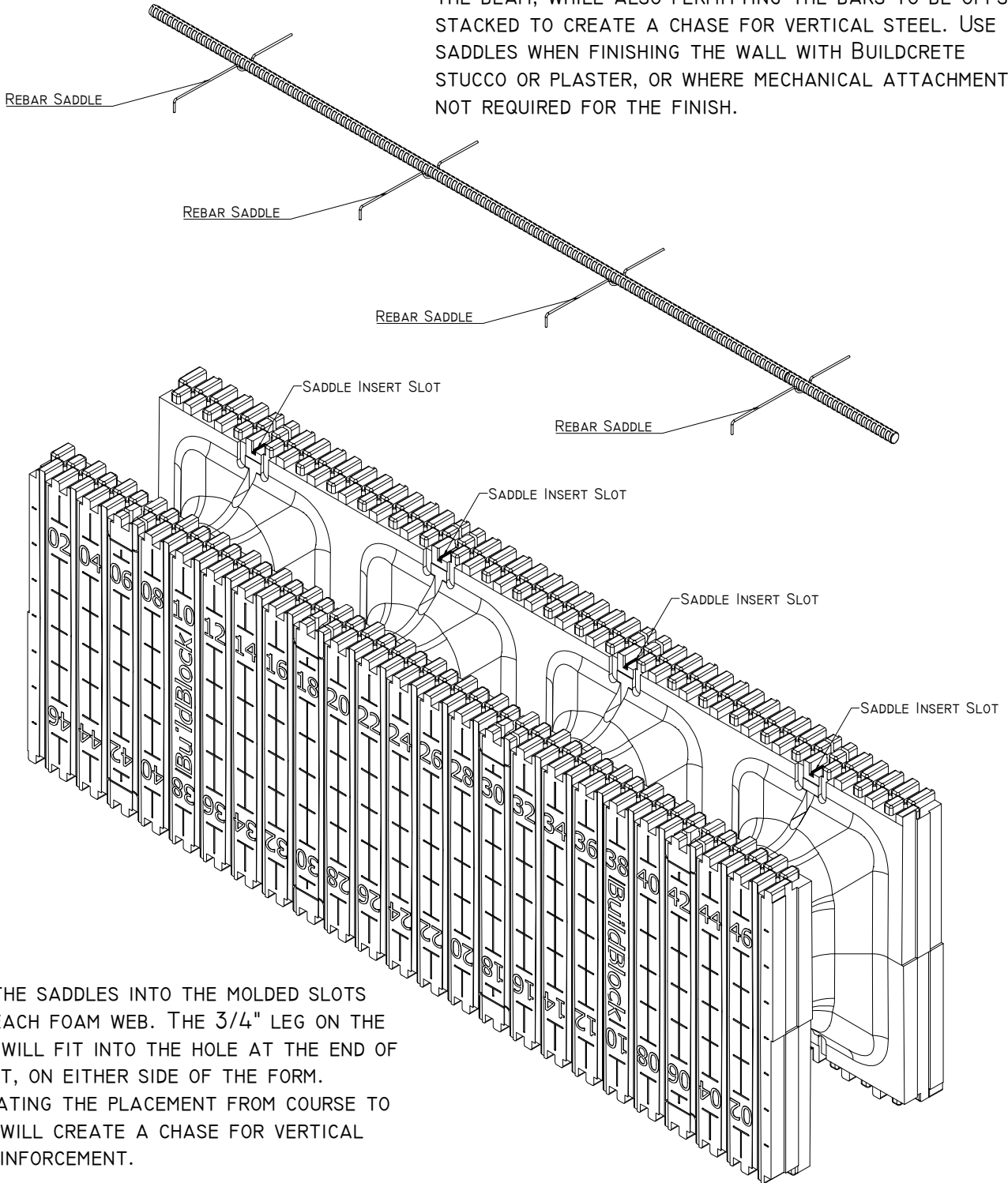

PLACE THE SADDLES INTO THE MOLDED SLOTS ABOVE EACH FOAM WEB. THE 3/4" LEG ON THE SADDLE WILL FIT INTO THE HOLE AT THE END OF THE SLOT, ON EITHER SIDE OF THE FORM. ALTERNATING THE PLACEMENT FROM COURSE TO COURSE WILL CREATE A CHASE FOR VERTICAL POST REINFORCEMENT.

REBAR PINS ARE REQUIRED FOR THE TOP COURSE TO ENSURE ADEQUATE CONCRETE COVER FOR TOP HORIZONTAL REINFORCEMENT. WIRE TIES ARE REQUIRED ON THIS COURSE TO MAINTAIN PLACEMENT OF HORIZONTAL AND VERTICAL REINFORCEMENT.

	GLOBALBLOCK USING REBAR SADDLES				
	DATE/REV	9/2015	SCALE	NTS	DETAIL SHEET
	NOTES				60N
OFFICE: 405-840-3386 TOLL FREE: 866-222-2575 FAX: 831-597-0792 BUILDBLOCK.COM	CONSTRUCTION SHALL BE IN ACCORDANCE WITH ALL APPLICABLE LOCAL AND NATIONAL CODES. ALL DRAWINGS ARE SUBJECT TO CHANGE WITHOUT NOTICE.				



GLOBALBLOCK ENGINEERING TABLES



NOTICE: This manual is a supplement to the BuildBlock Installation Manual and covers particular aspects of a GlobalBlock installation which differ from a standard ICF installation. Anything not covered in this manual is superseded by the BuildBlock Installation Manual, the Prescriptive Method, Local or International Codes, or Project Specific Engineering.

BUILDBLOCK BUILDING SYSTEMS GLOBALBLOCK ENGINEERING TABLES

GlobalBlock 300 High Wind Load Reinforcement Requirements 1 Story Structure

Wall Height	Wind Speed - Exposure Category B											
	100 mph		120 mph		140 mph		160 mph		180 mph		200 mph	
	Vasd = 77 mph		Vasd = 93 mph		Vasd = 108 mph		Vasd = 124 mph		Vasd = 139 mph		Vasd = 155 mph	
	Vertical	Horizontal	Vertical	Horizontal	Vertical	Horizontal	Vertical	Horizontal	Vertical	Horizontal	Vertical	Horizontal
8'	#4 @ 12"	#3 @ 16"	#4 @ 12"	#3 @ 16"	#4 @ 12"	#3 @ 16"	-	-	-	-	-	-
10'	-	-	-	-	-	-	-	-	-	-	-	-
12'	-	-	-	-	-	-	-	-	-	-	-	-

Wall Height	WIND SPEED - EXPOSURE CATEGORY C											
	100 mph		120 mph		140 mph		160 mph		180 mph		200 mph	
	Vasd = 77 mph		Vasd = 93 mph		Vasd = 108 mph		Vasd = 124 mph		Vasd = 139 mph		Vasd = 155 mph	
	Vertical	Horizontal	Vertical	Horizontal	Vertical	Horizontal	Vertical	Horizontal	Vertical	Horizontal	Vertical	Horizontal
8'	#4 @ 12"	#3 @ 16"	#4 @ 12"	#3 @ 16"	#4 @ 12"	#3 @ 16"	-	-	-	-	-	-
10'	-	-	-	-	-	-	-	-	-	-	-	-
12'	-	-	-	-	-	-	-	-	-	-	-	-

ASSUMPTIONS:

- Dead load = 25 psf.
- Live floor load = 40 psf.
- Live roof load = 20 psf.
- No snow load.
- No seismic load.
- Maximum clear span for floor trusses is 24'-0".
- Maximum clear span for roof trusses is 40'-0".
- Maximum mean roof height is 30'-0".
- Maximum (1) stories.
- Concrete strength: $f'_c = 3,000$ psi
- Reinforcement steel strength: $f_y = 60,000$ psi

	 <p>BUILDBLOCK BUILDING SYSTEMS, LLC Office: 405-840-3386 Toll Free: 866-222-2575 Fax: 831-597-0792 buildblock.com store.buildblock.com</p>	<p>TABLE NUMBER 10-A</p>
---	--	--

BUILDBLOCK BUILDING SYSTEMS GLOBALBLOCK ENGINEERING TABLES

GLOBALBLOCK 400 High Wind Load Reinforcement Requirements 1 Story Structure

Wall Height	WIND SPEED - EXPOSURE CATEGORY B											
	100 mph		120 mph		140 mph		160 mph		180 mph		200 mph	
	Vasd = 77 mph		Vasd = 93 mph		Vasd = 108 mph		Vasd = 124 mph		Vasd = 139 mph		Vasd = 155 mph	
	Vertical	Horizontal	Vertical	Horizontal	Vertical	Horizontal	Vertical	Horizontal	Vertical	Horizontal	Vertical	Horizontal
8'	#4 @ 24"	#3 @ 16"	#4 @ 24"	#3 @ 16"	#4 @ 24"	#3 @ 16"	#4 @ 24"	#3 @ 16"	#4 @ 24"	#3 @ 16"	#4 @ 24"	#3 @ 16"
10'	#4 @ 12"	#3 @ 16"	#4 @ 12"	#3 @ 16"	#4 @ 12"	#3 @ 16"	#4 @ 12"	#3 @ 16"	#4 @ 12"	#3 @ 16"	#4 @ 12"	#3 @ 16"
12'	-	-	-	-	-	-	-	-	-	-	-	-

Wall Height	WIND SPEED - EXPOSURE CATEGORY C											
	100 mph		120 mph		140 mph		160 mph		180 mph		200 mph	
	Vasd = 77 mph		Vasd = 93 mph		Vasd = 108 mph		Vasd = 124 mph		Vasd = 139 mph		Vasd = 155 mph	
	Vertical	Horizontal	Vertical	Horizontal	Vertical	Horizontal	Vertical	Horizontal	Vertical	Horizontal	Vertical	Horizontal
8'	#4 @ 24"	#3 @ 16"	#4 @ 24"	#3 @ 16"	#4 @ 24"	#3 @ 16"	#4 @ 24"	#3 @ 16"	#4 @ 24"	#3 @ 16"	#4 @ 24"	#3 @ 16"
10'	#4 @ 12"	#3 @ 16"	#4 @ 12"	#3 @ 16"	#4 @ 12"	#3 @ 16"	#4 @ 12"	#3 @ 16"	#4 @ 12"	#3 @ 16"	#4 @ 12"	#3 @ 16"
12'	-	-	-	-	-	-	-	-	-	-	-	-

ASSUMPTIONS:

- Dead load = 25 psf.
- Live floor load = 40 psf.
- Live roof load = 20 psf.
- No snow load.
- No seismic load.
- Maximum clear span for floor trusses is 24'-0".
- Maximum clear span for roof trusses is 40'-0".
- Maximum mean roof height is 30'-0".
- Maximum (1) stories.
- Concrete strength: $f'c = 3,000$ psi
- Reinforcement steel strength: $f_y = 60,000$ psi

 <p>MCLaren REGISTERED PROFESSIONAL ENGINEER</p>	 <p>BUILDBLOCK BUILDING SYSTEMS, LLC Office: 405-840-3386 Toll Free: 866-222-2575 Fax: 831-597-0792 buildblock.com store.buildblock.com</p>	<p>TABLE NUMBER 10-B</p>
--	--	--

BUILDBLOCK BUILDING SYSTEMS GLOBALBLOCK ENGINEERING TABLES

GLOBALBLOCK 400 High Wind Load Reinforcement Requirements 2 Story Structure

Wall Height	WIND SPEED - EXPOSURE CATEGORY B											
	100 mph		120 mph		140 mph		160 mph		180 mph		200 mph	
	Vasd = 77 mph		Vasd = 93 mph		Vasd = 108 mph		Vasd = 124 mph		Vasd = 139 mph		Vasd = 155 mph	
	Vertical	Horizontal	Vertical	Horizontal	Vertical	Horizontal	Vertical	Horizontal	Vertical	Horizontal	Vertical	Horizontal
8'	#4 @ 12"	#3 @ 16"	#4 @ 12"	#3 @ 16"	#4 @ 12"	#3 @ 16"	#4 @ 12"	#3 @ 16"	#4 @ 12"	#3 @ 16"	#4 @ 12"	#3 @ 16"
10'	-	-	-	-	-	-	-	-	-	-	-	-
12'	-	-	-	-	-	-	-	-	-	-	-	-

Wall Height	WIND SPEED - EXPOSURE CATEGORY C											
	100 mph		120 mph		140 mph		160 mph		180 mph		200 mph	
	Vasd = 77 mph		Vasd = 93 mph		Vasd = 108 mph		Vasd = 124 mph		Vasd = 139 mph		Vasd = 155 mph	
	Vertical	Horizontal	Vertical	Horizontal	Vertical	Horizontal	Vertical	Horizontal	Vertical	Horizontal	Vertical	Horizontal
8'	#4 @ 12"	#3 @ 16"	#4 @ 12"	#3 @ 16"	#4 @ 12"	#3 @ 16"	#5 @ 12"	#3 @ 16"	-	-	-	-
10'	-	-	-	-	-	-	-	-	-	-	-	-
12'	-	-	-	-	-	-	-	-	-	-	-	-

ASSUMPTIONS:

- Dead load = 25 psf.
- Live floor load = 40 psf.
- Live roof load = 20 psf.
- No snow load.
- No seismic load.
- Maximum clear span for floor trusses is 24'-0".
- Maximum clear span for roof trusses is 40'-0".
- Maximum mean roof height is 30'-0".
- Maximum (2) stories.
- Concrete strength: $f'_c = 3,000$ psi
- Reinforcement steel strength: $f_y = 60,000$ psi

 <p>MCLaren REGISTERED PROFESSIONAL ENGINEER</p>	 <p>BUILDBLOCK BUILDING SYSTEMS, LLC Office: 405-840-3386 Toll Free: 866-222-2575 Fax: 831-597-0792 buildblock.com store.buildblock.com</p>	<p>TABLE NUMBER 10-C</p>
--	--	--

BUILDBLOCK BUILDING SYSTEMS GLOBALBLOCK ENGINEERING TABLES

GLOBALBLOCK 600 High Wind Load Reinforcement Requirements 2 Story Structure

Wall Height	WIND SPEED - EXPOSURE CATEGORY C											
	100 mph		120 mph		140 mph		160 mph		180 mph		200 mph	
	Vasd = 77 mph		Vasd = 93 mph		Vasd = 108 mph		Vasd = 124 mph		Vasd = 139 mph		Vasd = 155 mph	
	Vertical	Horizontal	Vertical	Horizontal	Vertical	Horizontal	Vertical	Horizontal	Vertical	Horizontal	Vertical	Horizontal
8'	#4 @ 24"	#3 @ 16"	#4 @ 24"	#3 @ 16"	#4 @ 24"	#3 @ 16"	#4 @ 24"	#3 @ 16"	#4 @ 24"	#3 @ 16"	#4 @ 24"	#3 @ 16"
10'	#4 @ 12"	#3 @ 16"	#4 @ 12"	#3 @ 16"	#4 @ 12"	#3 @ 16"	#4 @ 12"	#3 @ 16"	#4 @ 12"	#3 @ 16"	#4 @ 12"	#3 @ 16"
12'	#4 @ 12"	#3 @ 16"	#4 @ 12"	#3 @ 16"	#4 @ 12"	#3 @ 16"	#4 @ 12"	#3 @ 16"	#4 @ 12"	#3 @ 16"	#4 @ 12"	#3 @ 16"

ASSUMPTIONS:

Dead load = 25 psf.

Live floor load = 40 psf.

Live roof load = 20 psf.

No snow load.

No seismic load.

Maximum clear span for floor trusses is 24'-0".

Maximum clear span for roof trusses is 40'-0".

Maximum mean roof height is 30'-0".

Maximum (2) stories.

Concrete strength: $f'c = 3,000$ psi

Reinforcement steel strength: $f_y = 60,000$ psi

	 <p>BUILDBLOCK BUILDING SYSTEMS, LLC Office: 405-840-3386 Toll Free: 866-222-2575 Fax: 831-597-0792 buildblock.com store.buildblock.com</p>	<p>TABLE NUMBER 10-D</p>
---	--	--

BUILDBLOCK BUILDING SYSTEMS GLOBALBLOCK ENGINEERING TABLES

GLOBALBLOCK 800 High Wind Load Reinforcement Requirements 2 Story Structure

Wall Height	WIND SPEED - EXPOSURE CATEGORY C											
	100 mph		120 mph		140 mph		160 mph		180 mph		200 mph	
	Vasd = 77 mph		Vasd = 93 mph		Vasd = 108 mph		Vasd = 124 mph		Vasd = 139 mph		Vasd = 155 mph	
	Vertical	Horizontal	Vertical	Horizontal	Vertical	Horizontal	Vertical	Horizontal	Vertical	Horizontal	Vertical	Horizontal
8'	#4 @ 48"	#3 @ 16"	#4 @ 48"	#3 @ 16"	#4 @ 48"	#3 @ 16"	#4 @ 36"	#3 @ 16"	#4 @ 36"	#3 @ 16"	#4 @ 36"	#3 @ 16"
10'	#4 @ 48"	#3 @ 16"	#4 @ 48"	#3 @ 16"	#4 @ 36"	#3 @ 16"	#4 @ 36"	#3 @ 16"	#4 @ 36"	#3 @ 16"	#4 @ 36"	#3 @ 16"
12'	#4 @ 48"	#3 @ 16"	#4 @ 36"	#3 @ 16"	#4 @ 36"	#3 @ 16"	#4 @ 24"	#3 @ 16"	#4 @ 24"	#3 @ 16"	#4 @ 24"	#3 @ 16"

ASSUMPTIONS:

Dead load = 25 psf.

Live floor load = 40 psf.

Live roof load = 20 psf.

No snow load.

No seismic load.

Maximum clear span for floor trusses is 24'-0".

Maximum clear span for roof trusses is 40'-0".

Maximum mean roof height is 30'-0".

Maximum (2) stories.

Concrete strength: $f'c = 3,000$ psi

Reinforcement steel strength: $f_y = 60,000$ psi

	 <p>BUILDBLOCK BUILDING SYSTEMS, LLC Office: 405-840-3386 Toll Free: 866-222-2575 Fax: 831-597-0792 buildblock.com store.buildblock.com</p>	<p>TABLE NUMBER 10-E</p>
---	--	--

BUILDBLOCK BUILDING SYSTEMS GLOBALBLOCK ENGINEERING TABLES

6" GLOBALBLOCK SCREEN GRID FORM

8-Foot High Basement Wall

Vertical (Grade 60) Rebar Requirements*

UNBALANCED BACKFILL DEPTH	BACKFILL EQUIVALENT FLUID DENSITY		
	30 PCF	45 PCF	60 PCF
5 ft.	#3@12";#4@36"; #5@48"	#3@12";#4@24"; #5@36';#6@48"	#4@12";#5@24" ;#6@24"
5.5 ft.	#3@12"; #4@24"; #5@36';#6@48"	#3@12";#4@24"; #5@36';#6@48"	#4@12";#5@12" ;#6@24"
6 ft.	#3@12"; #4@24"; #5@24";#6@36"	#4@12';@5@24" ;#6@36"	#4@12';#5@12" ;#6@12"
6.5 ft.	#3@12"; #4@12"; #5@24";#6@24"	#4@12';@5@12" ;#6@24"	#5@12" ;#6@12"
7 ft.	#4@12"; #5@24";#6@24"	#5@12" ;#6@12"	#5@12" ;#6@12"
7.5 ft.	#4@12"; #5@12";#6@24"	#5@12" ;#6@12"	#6 @ 12" (fc=3,000 psi)
8 ft.	#4@12"; #5@12";#6@24"	#5@12" ;#6@12"	#6 @ 12" (fc=3,000 psi)

*MINIMUM REBAR REQUIREMENTS

- If the basement wall is NOT supporting an above grade wall in Seismic Design areas: Vertical rebar size and spacing per table above. Minimum horizontal rebar is #4@32" o.c.
- Vertical rebar size and spacing shall match the above grade all reinforcement if more restrictive.

NOTES

1. This table is based on the design criteria of ACI 318-08 "Building Code Requirements for Structural Concrete"
2. The reinforcement requirements listed in this table are based on Grade 60 (ASTM A 615 or ASTM A 996) rebar and 2,500 psi concrete
3. This table assumes the vertical rebar is placed in the center of the 11" thick GlobalBlock wall (D=4.625), unless otherwise noted with an offset dimension ("d") measured from the outside edge of form (backfill side of the wall.)
4. The basement floor must be poured and the first floor in place before the backfilling.
5. The floor or roof system supporting the top of the basement wall and the connection to the top of the basement wall, must be specifically designed to provide the necessary strength to resist the horizontal reaction or force developed at the top of the basement wall by the lateral loads exerted on the wall by the backfill.
6. Concrete must cure a minimum of 7 days before backfilling.
7. Backfill should be well drained.
8. Refer to the BuildBlock Installation Manual for proper basement drainage and waterproofing systems.

	 <p>BUILDBLOCK BUILDING SYSTEMS, LLC Office: 405-840-3386 Toll Free: 866-222-2575 Fax: 831-597-0792 buildblock.com store.buildblock.com</p>	<p>TABLE NUMBER 11-A</p>
---	--	--

BUILDBLOCK BUILDING SYSTEMS GLOBALBLOCK ENGINEERING TABLES

6" GLOBALBLOCK SCREEN GRID FORM

9-Foot High Basement Wall

Vertical (Grade 60) Rebar Requirements*

UNBALANCED BACKFILL DEPTH	BACKFILL EQUIVALENT FLUID DENSITY		
	30 PCF	45 PCF	60 PCF
5 ft.	#3@12";#4@24"; #5@36"; #6@48"	#4@12"; #5@24";#6@36"	#4@12";#5@24" ;#6@24"
5.5 ft.	#3@12";#4@24"; #5@36"; #6@48"	#4@12"; #5@24";#6@36"	#4@12";#5@12" ;#6@24"
6 ft.	#3@12"; #4@12"; #5@24";#6@36"	#4@12";@5@24" ;#6@24"	#5@12" ;#6@12"
6.5 ft.	#4@12"; #5@24";#6@24"	#4@12";@5@12" ;#6@24"	#5@12" ;#6@12"
7 ft.	#4@12"; #5@12";#6@24"	#5@12" ;#6@12"	#6 @ 12" (fc=3,000 psi)
7.5 ft.	#4@12"; #5@12";#6@24"	#5@12" ;#6@12"	#6 @ 12" (fc=3,000 psi)
8 ft.	#5@12";#6@12"	#6 @ 12" (fc=3,000 psi)	#5@12"(d=6.25") (fc=3,000 psi)
8.5 ft.	#5@12";#6@12"	#6 @ 12" (fc=3,000 psi)	#5@12"(d=6.25") (fc=3,000 psi)
9 ft.	#5@12";#6@12"	#5@12" (d=6.25") (fc=3,000 psi)	#5@12"(d=6.25") (fc=3,000 psi)

*MINIMUM REBAR REQUIREMENTS

- If the basement wall is NOT supporting an above grade wall in Seismic Design areas: Vertical rebar size and spacing per table above. Minimum horizontal rebar is #4@32" o.c.
- Vertical rebar size and spacing shall match the above grade all reinforcement if more restrictive.

NOTES

- This table is based on the design criteria of ACI 318-08 "Building Code Requirements for Structural Concrete"
- The reinforcement requirements listed in this table are based on Grade 60 (ASTM A 615 or ASTM A 996) rebar and 2,500 psi concrete
- This table assumes the vertical rebar is placed in the center of the 11" thick GlobalBlock wall (D=4.625), unless otherwise noted with an offset dimension ("d") measured from the outside edge of form (backfill side of the wall.)
- The basement floor must be poured and the first floor in place before the backfilling.
- The floor or roof system supporting the top of the basement wall and the connection to the top of the basement wall, must be specifically designed to provide the necessary strength to resist the horizontal reaction or force developed at the top of the basement wall by the lateral loads exerted on the wall by the backfill.
- Concrete must cure a minimum of 7 days before backfilling.
- Backfill should be well drained.
- Refer to the BuildBlock Installation Manual for proper basement drainage and waterproofing systems.

	 <p>BUILDBLOCK BUILDING SYSTEMS, LLC Office: 405-840-3386 Toll Free: 866-222-2575 Fax: 831-597-0792 buildblock.com store.buildblock.com</p>	<p>TABLE NUMBER 11-B</p>
---	--	--

BUILDBLOCK BUILDING SYSTEMS GLOBALBLOCK ENGINEERING TABLES

6" GLOBALBLOCK SCREEN GRID FORM

10-Foot High Basement Wall

Vertical (Grade 60) Rebar Requirements*

UNBALANCED BACKFILL DEPTH	BACKFILL EQUIVALENT FLUID DENSITY		
	30 PCF	45 PCF	60 PCF
5 ft.	#3@12"; #4@24"; #5@36"; #6@48"	#3@12"; #4@24"; #5@36"; #6@48"	#4@12"; #5@12"; #6@24"
5.5 ft.	#3@12"; #4@24"; #5@36"; #6@48"	#4@12"; #5@24"; #6@36"	#4@12"; #5@12"; #6@24"
6 ft.	#3@12"; #4@12"; #5@24"; #6@36"	#4@12"; #5@12"; #6@24"	#5@12"; #6@12"
6.5 ft.	#4@12"; #5@24"; #6@24"	#5@12"; #6@12"	#5@12"; #6@12"
7 ft.	#4@12"; #5@12"; #6@24"	#5@12"; #6@12"	#6 @ 12" (fc=3,000 psi)
7.5 ft.	#4@12"; #5@12"; #6@12"	#5@12"; #6@12" (fc=3,000 psi)	#5@12"(d=6.25") (fc=3,000 psi)
8 ft.	#5@12"; #6@12"	#6 @ 12" (fc=3,000 psi)	#5@12"(d=6.25") (fc=3,000 psi)
8.5 ft.	#5@12"; #6@12"	#5@12" (d=6.25") (fc=3,000 psi)	#5@12"(d=6.25") (fc=3,000 psi)
9 ft.	#6@12"	#5@12" (d=6.25") (fc=3,000 psi)	#6@12"(d=6.25") (fc=3,000 psi)
9.5 ft.	#6@12"	#5@12" (d=6.25") (fc=3,000 psi)	#6@12"(d=6.25") (fc=3,000 psi)
10 ft.	#6@12"	#5@12" (d=6.25") (fc=3,000 psi)	#6@12"(d=6.25") (fc=3,000 psi)

*MINIMUM REBAR REQUIREMENTS

- If the basement wall is NOT supporting an above grade wall in Seismic Design areas: Vertical rebar size and spacing per table above. Minimum horizontal rebar is #4@32" o.c.
- Vertical rebar size and spacing shall match the above grade all reinforcement if more restrictive.

NOTES

1. This table is based on the design criteria of ACI 318-08 "Building Code Requirements for Structural Concrete"
2. The reinforcement requirements listed in this table are based on Grade 60 (ASTM A 615 or ASTM A 996) rebar and 2,500 psi concrete
3. This table assumes the vertical rebar is placed in the center of the 11" thick GlobalBlock wall (D=4.625), unless otherwise noted with an offset dimension ("d") measured from the outside edge of form (backfill side of the wall.)
4. The basement floor must be poured and the first floor in place before the backfilling.
5. The floor or roof system supporting the top of the basement wall and the connection to the top of the basement wall, must be specifically designed to provide the necessary strength to resist the horizontal reaction or force developed at the top of the basement wall by the lateral loads exerted on the wall by the backfill.
6. Concrete must cure a minimum of 7 days before backfilling.
7. Backfill should be well drained.
8. Refer to the BuildBlock Installation Manual for proper basement drainage and waterproofing systems.

	 <p style="text-align: center;">BUILDBLOCK BUILDING SYSTEMS, LLC Office: 405-840-3386 Toll Free: 866-222-2575 Fax: 831-597-0792 buildblock.com store.buildblock.com</p>	<p style="text-align: center;">TABLE NUMBER 11-C</p>
---	--	--

BUILDBLOCK BUILDING SYSTEMS GLOBALBLOCK ENGINEERING TABLES

8" GLOBALBLOCK SCREEN GRID FORM

8-Foot High Basement Wall

Vertical (Grade 60) Rebar Requirements*

UNBALANCED BACKFILL DEPTH	BACKFILL EQUIVALENT FLUID DENSITY		
	30 PCF	45 PCF	60 PCF
5 ft.	#3@24"; #4@36"; #5@48"	#3@12";#4@24"; #5@36";#6@48"	#4@12";#5@24" ;#6@36"
5.5 ft.	#3@12"; #4@24"; #5@36";#6@48"	#3@12";#4@24"; #5@36";#6@48"	#4@12";#5@24" ;#6@24"
6 ft.	#3@12"; #4@24"; #5@36";#6@48"	#4@12";@5@24" ;#6@36"	#4@12";#5@12" ;#6@24"
6.5 ft.	#3@12"; #4@12"; #5@24";#6@36"	#4@12";@5@24" ;#6@24"	#5@12" ;#6@12"
7 ft.	#4@12"; #5@24";#6@36"	#4@12";@5@12" ;#6@24"	#5@12" ;#6@12"
7.5 ft.	#4@12"; #5@24";#6@24"	#5@12" ;#6@24"	#5@12" ;#6@12"
8 ft.	#4@12"; #5@12";#6@24"	#5@12" ;#6@12"	#6@12"

***MINIMUM REBAR REQUIREMENTS**

- If the basement wall is NOT supporting an above grade wall in Seismic Design areas: Vertical rebar size and spacing per table above. Minimum horizontal rebar is #4@32" o.c.
- Vertical rebar size and spacing shall match the above grade all reinforcement if more restrictive.

NOTES

1. This table is based on the design criteria of ACI 318-08 "Building Code Requirements for Structural Concrete"
2. The reinforcement requirements listed in this table are based on Grade 60 (ASTM A 615 or ASTM A 996) rebar and 2,500 psi concrete
3. This table assumes the vertical rebar is placed in the center of the 11" thick GlobalBlock wall (D=4.625), unless otherwise noted with an offset dimension ("d") measured from the outside edge of form (backfill side of the wall.)
4. The basement floor must be poured and the first floor in place before the backfilling.
5. The floor or roof system supporting the top of the basement wall and the connection to the top of the basement wall, must be specifically designed to provide the necessary strength to resist the horizontal reaction or force developed at the top of the basement wall by the lateral loads exerted on the wall by the backfill.
6. Concrete must cure a minimum of 7 days before backfilling.
7. Backfill should be well drained.
8. Refer to the BuildBlock Installation Manual for proper basement drainage and waterproofing systems.

	 <p>BUILDBLOCK BUILDING SYSTEMS, LLC Office: 405-840-3386 Toll Free: 866-222-2575 Fax: 831-597-0792 buildblock.com store.buildblock.com</p>	<p>TABLE NUMBER 11-D</p>
---	--	--

BUILDBLOCK BUILDING SYSTEMS GLOBALBLOCK ENGINEERING TABLES

8" GLOBALBLOCK SCREEN GRID FORM

9-Foot High Basement Wall

Vertical (Grade 60) Rebar Requirements*

UNBALANCED BACKFILL DEPTH	BACKFILL EQUIVALENT FLUID DENSITY		
	30 PCF	45 PCF	60 PCF
5 ft.	#3@24"; #4@48"	#3@12"; #4@36"; #5@48"	#3@12"; #4@24"; #5@36"; #6@48"
5.5 ft.	#3@24"; #4@36"; #5@48"	#3@12"; #4@24"; #5@36"; #6@48"	#3@12"; #4@12"; #5@24"; #6@36"
6 ft.	#3@12"; #4@24"; #5@48"	#3@12"; #4@24"; #5@36"; #6@48"	#4@12"; #5@24"; #6@24"
6.5 ft.	#3@12"; #4@24"; #5@36"; #6@48"	#4@12"; #5@24"; #6@36"	#4@12"; #5@12"; #6@24"
7 ft.	#3@12"; #4@24"; #5@36"; #6@36"	#4@12"; #5@24"; #6@24"	#4@12"; #5@12"; #6@12"
7.5 ft.	#3@12"; #4@12"; #5@24"; #6@36"	#4@12"; #5@12"; #6@24"	#5@12"; #6@12"
8 ft.	#4@12"; #5@24"; #6@24"	#4@12"; #5@12"; #6@24"	#5@12"; #6@12"
8.5 ft.	#4@12"; #5@12"; #6@24"	#5@12"; #6@12"	#6@12"
9 ft.	#4@12"; #5@12"; #6@24"	#5@12"; #6@12"	#6@12"

***MINIMUM REBAR REQUIREMENTS**

- If the basement wall is NOT supporting an above grade wall in Seismic Design areas: Vertical rebar size and spacing per table above. Minimum horizontal rebar is #4@32" o.c.
- Vertical rebar size and spacing shall match the above grade all reinforcement if more restrictive.

NOTES

1. This table is based on the design criteria of ACI 318-08 "Building Code Requirements for Structural Concrete"
2. The reinforcement requirements listed in this table are based on Grade 60 (ASTM A 615 or ASTM A 996) rebar and 2,500 psi concrete
3. This table assumes the vertical rebar is placed in the center of the 11" thick GlobalBlock wall (D=4.625), unless otherwise noted with an offset dimension ("d") measured from the outside edge of form (backfill side of the wall.)
4. The basement floor must be poured and the first floor in place before the backfilling.
5. The floor or roof system supporting the top of the basement wall and the connection to the top of the basement wall, must be specifically designed to provide the necessary strength to resist the horizontal reaction or force developed at the top of the basement wall by the lateral loads exerted on the wall by the backfill.
6. Concrete must cure a minimum of 7 days before backfilling.
7. Backfill should be well drained.
8. Refer to the BuildBlock Installation Manual for proper basement drainage and waterproofing systems.

	 <p>BUILDBLOCK BUILDING SYSTEMS, LLC Office: 405-840-3386 Toll Free: 866-222-2575 Fax: 831-597-0792 buildblock.com store.buildblock.com</p>	<p>TABLE NUMBER 11-E</p>
---	--	--

BUILDBLOCK BUILDING SYSTEMS GLOBALBLOCK ENGINEERING TABLES

8" GLOBALBLOCK SCREEN GRID FORM

10-Foot High Basement Wall

Vertical (Grade 60) Rebar Requirements*

UNBALANCED BACKFILL DEPTH	BACKFILL EQUIVALENT FLUID DENSITY		
	30 PCF	45 PCF	60 PCF
5 ft.	#3@24"; #4@48"	#3@12";#4@36"; #5@48"	#3@12";#4@24"; #5@36";#6@48"
5.5 ft.	#3@24"; #4@36";#5@48"	#3@12";#4@24"; #5@36";#6@48"	#4@12";#5@24"; #6@36"
6 ft.	#3@12"; #4@24"; #5@36";#6@48"	#3@12";#4@24"; #5@36";#6@36"	#4@12";#5@24"; #6@24"
6.5 ft.	#3@12"; #4@24"; #5@36";#6@48"	#4@12"; #5@24";#6@36"	#4@12";#5@12"; #6@24"
7 ft.	#3@12"; #4@12"; #5@24";#6@36"	#4@12"; #5@24";#6@24"	#5@12";#6@12"
7.5 ft.	#4@12"; #5@24";#6@36"	#4@12"; #5@12";#6@24"	#5@12";#6@12"
8 ft.	#4@12"; #5@24";#6@24"	#5@12";#6@12"	#5@12";#6@12"
8.5 ft.	#4@12"; #5@12";#6@24"	#5@12";#6@12"	#6@12"
9 ft.	#4@12"; #5@12";#6@24"	#5@12";#6@12"	#6@12"
9.5 ft.	#5@12";#6@12"	#6@12"	#5@12" (d=8")
10 ft.	#5@12";#6@12"	#6@12"	#5@12" (d=8")

***MINIMUM REBAR REQUIREMENTS**

- If the basement wall is NOT supporting an above grade wall in Seismic Design areas: Vertical rebar size and spacing per table above. Minimum horizontal rebar is #4@32" o.c.
- Vertical rebar size and spacing shall match the above grade all reinforcement if more restrictive.

NOTES

1. This table is based on the design criteria of ACI 318-08 "Building Code Requirements for Structural Concrete"
2. The reinforcement requirements listed in this table are based on Grade 60 (ASTM A 615 or ASTM A 996) rebar and 2,500 psi concrete
3. This table assumes the vertical rebar is placed in the center of the 11" thick GlobalBlock wall (D=4.625), unless otherwise noted with an offset dimension ("d") measured from the outside edge of form (backfill side of the wall.)
4. The basement floor must be poured and the first floor in place before the backfilling.
5. The floor or roof system supporting the top of the basement wall and the connection to the top of the basement wall, must be specifically designed to provide the necessary strength to resist the horizontal reaction or force developed at the top of the basement wall by the lateral loads exerted on the wall by the backfill.
6. Concrete must cure a minimum of 7 days before backfilling.
7. Backfill should be well drained.
8. Refer to the BuildBlock Installation Manual for proper basement drainage and waterproofing systems.

 <p>MCLaren REGISTERED PROFESSIONAL ENGINEER</p>	 <p>BUILDBLOCK BUILDING SYSTEMS, LLC Office: 405-840-3386 Toll Free: 866-222-2575 Fax: 831-597-0792 buildblock.com store.buildblock.com</p>	<p>TABLE NUMBER 11-F</p>
--	--	--

BUILDBLOCK BUILDING SYSTEMS GLOBALBLOCK ENGINEERING TABLES

4" GLOBALBLOCK SCREEN GRID FORM

Table 5.10 A&B
Maximum Allowable Clear Spans (feet-inches) for
Screen Grid ICF Lintels in Load-Bearing Walls (*See Notes)

No. 4 Bottom Bar Size

Minimum Lintel Thickness, T (inches)	Minimum Lintel Depth, D (inches)	Supporting Light Frame Roof Only		Supporting Light Frame Second Story and Roof		Supporting ICF Second Story and Light Frame Roof	
		Maximum Ground Snow Load (psf)					
		30	70	30	70	30	70
4	16	2-0	1-6	1-8	1-6	N/A	N/A
	24	3-6*	2-6	2-6	2-0	2-0	2-0

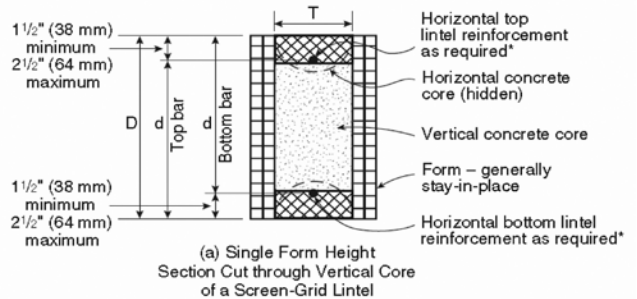

No. 5 Bottom Bar Size

Minimum Lintel Thickness, T (inches)	Minimum Lintel Depth, D (inches)	Supporting Light Frame Roof Only		Supporting Light Frame Second Story and Roof		Supporting ICF Second Story and Light Frame Roof	
		Maximum Ground Snow Load (psf)					
		30	70	30	70	30	70
4	16	2-0	1-6	1-8	1-6	N/A	N/A
	24	3-6*	2-6	2-6	2-0	2-0	2-0

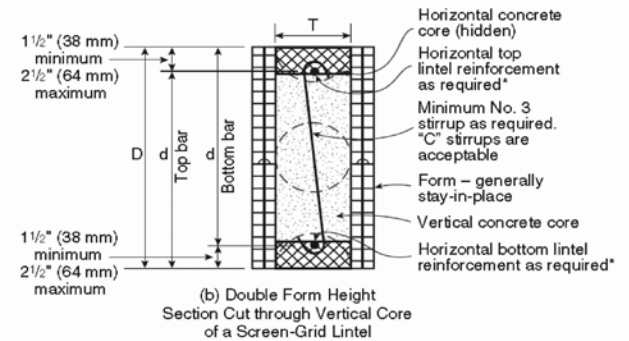

*For bundled bars, see Section 7.2.2.

Note: Cross-hatching represents the area in which form material shall be removed, if necessary, to create flanges continuous the length of the lintel. Flanges shall have a minimum thickness of 2.5" and a minimum width of 5".

- Table values are based on concrete with a minimum specified compressive strength of 2,500 psi (17.2 MPa), reinforcing steel with a minimum yield strength of 40,000 psi (276 MPa), and a building width floor clear span of 24 feet and roof clear span of 32 feet (9.8m), D/R indicates design required.
- Stirrups shall be required at a maximum spacing of 12 inches (304.8mm) on center for 16 in (406.4mm) and 32 in (812.8mm) deep screen-grid lintels.
- Deflection criterion is $l/240$, where L is the clear span of the lintel in inches.
- Linear interpolation is permitted between ground now loads and between lintel depths. Lintel depth, D, is permitted to include the available height of any ICF wall location directly above the lintel, provided that the increased lintel depth spans the entire length of the lintel.
- Flat ICF lintel may be used in lieu of screen-grid lintels.
- Lintel thickness corresponds to the nominal screen-grid IFC wall thickness. For actual wall thickness.
- Refer to PCA 100-2012 Prescriptive Design & Exterior Concrete Walls for design assumption and background information
- Supported ICF wall dead load is approximately 30 psf
- Allowable Lintel Span can be 6'-0" for load bearing walls with concrete compressive strength of 3,500 psi (or greater) and for non-load bearing walls.

	<p>BUILDBLOCK BUILDING SYSTEMS, LLC Office: 405-840-3386 Toll Free: 866-222-2575 Fax: 831-597-0792 buildblock.com store.buildblock.com</p>	<p>TABLE NUMBER 12-A</p>
--	---	--

BUILDBLOCK BUILDING SYSTEMS GLOBALBLOCK ENGINEERING TABLES

6" GLOBALBLOCK SCREEN GRID FORM

Table 5.10 A&B
Maximum Allowable Clear Spans (feet-inches) for
Screen Grid ICF Lintels in Load-Bearing Walls (*See Notes)

No. 4 Bottom Bar Size

Minimum Lintel Thickness, T (inches)	Minimum Lintel Depth, D (inches)	Supporting Light Frame Roof Only		Supporting Light Frame Second Story and Roof		Supporting ICF Second Story and Light Frame Roof	
		Maximum Ground Snow Load (psf)					
		30	70	30	70	30	70
6	16	4-5	3-6	3-8	3-5	3-3	3-1
	24	9-11	7-8	8-0	7-2	6-8	6-2

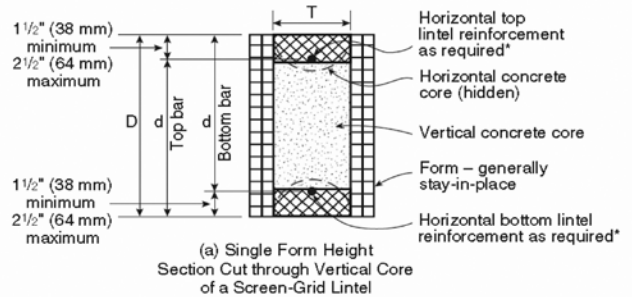

No. 5 Bottom Bar Size

Minimum Lintel Thickness, T (inches)	Minimum Lintel Depth, D (inches)	Supporting Light Frame Roof Only		Supporting Light Frame Second Story and Roof		Supporting ICF Second Story and Light Frame Roof	
		Maximum Ground Snow Load (psf)					
		30	70	30	70	30	70
6	16	4-5	3-6	3-8	3-5	3-3	3-1
	24	12-5	9-7	9-11	8-11	8-3	7-8

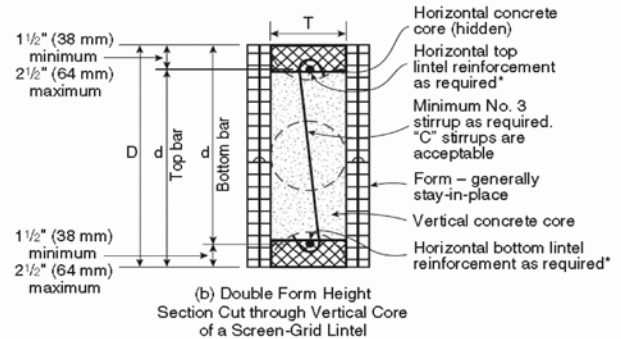

*For bundled bars, see Section 7.2.2.

Note: Cross-hatching represents the area in which form material shall be removed, if necessary, to create flanges continuous the length of the lintel. Flanges shall have a minimum thickness of 2.5" and a minimum width of 5".

- Table values are based on concrete with a minimum specified compressive strength of 2,500 psi (17.2 MPa), reinforcing steel with a minimum yield strength of 40,000 psi (276 MPa), and a building width) floor clear span of 24 feet and roof clear span of 32 feet (9.8m), D/R indicates design required.
- Stirrups shall be required at a maximum spacing of 12 inches (304.8mm) on center for 16 in (406.4mm) and 32 in (812.8mm) deep screen-grid lintels.
- Deflection criterion is $l/240$, where L is the clear span of the lintel in inches.
- Linear interpolation is permitted between ground now loads and between lintel depths. Lintel depth, D, is permitted to include the available height of any ICF wall
- Location directly above the lintel, provided that the increased lintel depth spans the entire length of the lintel.
- Flat ICF lintel may be used in lieu of screen-grid lintels.
- Lintel thickness corresponds to the nominal screen-grid IFC wall thickness. For actual wall thickness.
- Refer to PCA 100-2012 Prescriptive Design & Exterior Concrete Walls for design assumption and background information.
- Supported ICF wall dead load is 53 psf (2.5kPA).

<p>MCLaren REGISTERED PROFESSIONAL ENGINEER</p>	<p>BUILDBLOCK BUILDING SYSTEMS, LLC Office: 405-840-3386 Toll Free: 866-222-2575 Fax: 831-597-0792 buildblock.com store.buildblock.com</p>	<p>TABLE NUMBER 12-B</p>
--	---	--

BUILDBLOCK BUILDING SYSTEMS GLOBALBLOCK ENGINEERING TABLES

8" GLOBALBLOCK SCREEN GRID FORM

Table 5.10 A&B
Maximum Allowable Clear Spans (feet-inches) for
Screen Grid ICF Lintels in Load-Bearing Walls (*See Notes)

No. 4 Bottom Bar Size

Minimum Lintel Thickness, T (inches)	Minimum Lintel Depth, D (inches)	Supporting Light Frame Roof Only		Supporting Light Frame Second Story and Roof		Supporting ICF Second Story and Light Frame Roof	
		Maximum Ground Snow Load (psf)					
		30	70	30	70	30	70
8	16	7-6	5-3	5-6	5-2	4-9	4-6
	24	12-0	11-6	11-6	10-6	10-0	9-0

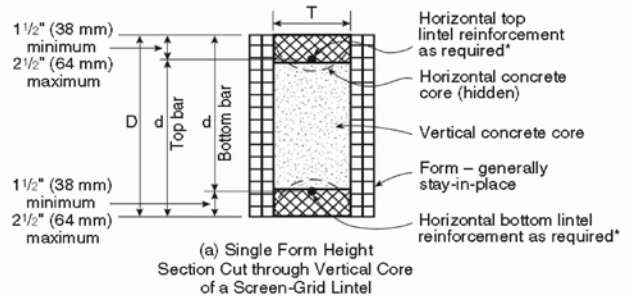

No. 5 Bottom Bar Size

Minimum Lintel Thickness, T (inches)	Minimum Lintel Depth, D (inches)	Supporting Light Frame Roof Only		Supporting Light Frame Second Story and Roof		Supporting ICF Second Story and Light Frame Roof	
		Maximum Ground Snow Load (psf)					
		30	70	30	70	30	70
8	16	7-6	5-3	5-6	5-2	4-9	4-6
	24	12-0	11-6	11-6	10-6	10-0	9-0

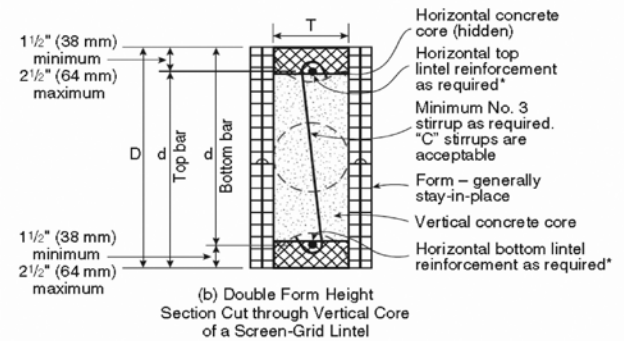

*For bundled bars, see Section 7.2.2.

Note: Cross-hatching represents the area in which form material shall be removed, if necessary, to create flanges continuous the length of the lintel. Flanges shall have a minimum thickness of 2.5" and a minimum width of 5".

- Table values are based on concrete with a minimum specified compressive strength of 2,500 psi (17.2 MPa), reinforcing steel with a minimum yield strength of 40,000 psi (276 MPa), and a building width floor clear span of 24 feet and roof clear span of 32 feet (9.8m), D/R indicates design required.
- Stirrups shall be required at a maximum spacing of 12 inches (304.8mm) on center for 16 in (406.4mm) and 32 in (812.8mm) deep screen-grid lintels.
- Deflection criterion is $l/240$, where L is the clear span of the lintel in inches.
- Linear interpolation is permitted between ground now loads and between lintel depths. Lintel depth, D, is permitted to include the available height of any ICF wall location directly above the lintel, provided that the increased lintel depth spans the entire length of the lintel.
- Flat ICF lintel may be used in lieu of screen-grid lintels.
- Lintel thickness corresponds to the nominal screen-grid IFC wall thickness. For actual wall thickness.
- Refer to PCA 100-2012 Prescriptive Design & Exterior Concrete Walls for design assumption and background information.
- Supported ICF wall dead load is approximately 75 psf.



BUILDBLOCK BUILDING SYSTEMS, LLC
Office: 405-840-3386 | Toll Free: 866-222-2575 | Fax: 831-597-0792
buildblock.com | store.buildblock.com



TABLE NUMBER
12-C

BUILDBLOCK BUILDING SYSTEMS GLOBALBLOCK ENGINEERING TABLES

MAXIMUM ALLOWABLE CLEAR SPANS FOR 6-INCH THICK SCREEN-GRID LINTELS IN LOAD-BEARING WALLS 1,2,3,4,5,6,16 ROOF CLEAR SPAN 32 FEET AND FLOOR CLEAR SPAN 24 FEET

Lintel Depth 7, <i>D</i> (in.)	Number of bars and bar size in top and bottom of lintel	Steel yield strength 8, <i>f_y</i> (psi)	Loading condition determined from Table 7.2								
			1	2		3		4		5	
			Maximum ground snow load (psf)								
			30	70	30	70	30	70	30	70	
Maximum clear span of lintel (ft-inches)											
12 ^{9,10}	Span without stirrups 13		2-9	2-11	2-4	2-5	2-3	2-3	2-2	2-0	2-0
16 ^{9,10}	Span without stirrups 13		3-9	4-0	3-4	3-5	3-2	3-1	3-0	2-9	2-9
20 ^{9,10}	Span without stirrups 13		4-9	5-1	4-3	4-4	4-1	4-0	3-10	3-7	3-7
24 ¹¹	Span without stirrups 12,13		5-8	6-3	5-2	5-3	5-0	4-10	4-8	4-4	4-4
	1 - #4	40,000	7-11	9-0	6-11	7-2	6-5	6-1	5-8	4-9	4-7
		60,000	9-9	11-0	8-5	8-9	7-10	7-5	6-10	5-9	5-7
	1 - #5	40,000	9-11	11-2	8-7	8-1	8-0	7-7	7-0	5-11	5-9
		60,000	12-1	13-8	10-6	10-10	9-9	9-3	8-6	7-2	7-0
	2 - #4 1 - #6	40,000	11-2	12-8	9-9	10-1	9-1	8-7	7-11	6-8	6-6
		60,000	15-7	17-7	12-8	13-4	11-6	10-8	9-8	7-11	7-8
	2 - #5	40,000	14-11	18-0	12-2	12-10	11-1	10-3	9-4	7-8	7-5
60,000		DR	DR	DR	DR	DR	DR	DR	DR	DR	
Center distance <i>A</i> ^{14,15}			2-0	2-6	1-6	1-7	1-4	1-2	1-0	STL	STL

1. For SI: 1 inch = 25.4 mm; 1 psf = 0.0479 kN/m²; 1 ft. = 0.3048 m; Grade 40 = 280 MPa; Grade 60 = 420 MPa. Where lintels are formed with screen-grid forms, form material shall be removed if necessary to create top and bottom flanges of the lintel that are not less than 5 inches (127 mm) in width and not less than 2.5 inches (64 mm) in depth (in the vertical direction). See Figure 7.5. Flat stay-in-place form lintels shall be permitted to be used in lieu of screen-grid lintels. See Tables 7.3 through 7.10.
2. See Table 2.1 for tolerances permitted from nominal thickness and minimum dimensions and spacings of cores.
3. Table values are based on concrete with a minimum specified compressive strength of 2,500 psi (17.2 MPa). See notes 13 and 15. Table values are based on uniform loading. See Section 7.2 for lintels supporting concentrated loads.
4. Deflection criterion is L/240, where L is the clear span of the lintel in inches, or 1/2-inch (13 mm), whichever is less.
5. Linear interpolation is permitted between ground snow loads.
6. DR indicates design required STL indicates stirrups required throughout lintel
7. Lintel depth, *D*, is permitted to include the available height of wall located directly above the lintel, provided that the increased lintel depth spans the entire length of the lintel.
8. Stirrups shall be fabricated from reinforcing bars with the same yield strength as that used for the main longitudinal reinforcement.
9. Stirrups are not required for lintels less than 24 inches (610 mm) in depth fabricated from screen-grid forms. Top and bottom reinforcement shall consist of a No. 4 bar having a yield strength of 40,000 psi (280 MPa) or 60,000 psi (420 MPa).
10. Lintels between 12 (305) and 24 inches (610 mm) in depth with stirrups shall be formed from flat-walls forms (see Tables 7.3 through 7.10), or form material shall be removed from screen-grid forms so as to provide a concrete section comparable to that required for a flat wall. Allowable spans for flat lintels with stirrups shall be determined from Tables 7.3 through 7.10.
11. Where stirrups are required for 24-inch (610 mm) deep lintels, the spacing shall not exceed 12 inches (305 mm) on center.
12. Allowable clear span without stirrups applicable to all lintels of the same depth, *D*. Top and bottom reinforcement for lintels without stirrups shall not be less than the least amount of reinforcement required for a lintel of the same depth and loading condition with stirrups. All other spans require stirrups spaced at not more than 12 inches (305 mm).
13. Where concrete with a minimum specified compressive strength of 3,000 psi (20.7 MPa) is used, clear spans for lintels without stirrups shall be permitted to be multiplied by 1.05. If the increased span exceeds the allowable clear span for a lintel of the same depth and loading condition with stirrups, the top and bottom reinforcement shall be equal to or greater than that required for a lintel of the same depth and loading condition that has an allowable clear span that is equal to or greater than that of the lintel without stirrups that has been increased.
14. Center distance, *A*, is the center portion of the span where stirrups are not required. This is applicable to all longitudinal bar sizes and steel yield strengths.
15. Where concrete with a minimum specified compressive strength of 3,000 psi (20.7 MPa) is used, center distance, *A*, shall be permitted to be multiplied by 1.10.
16. The maximum clear opening width between two solid wall segments shall be 18 feet (5.5 m). See Section 5.2.1. Lintel spans in table greater than 18 feet (5.5 m) are shown for interpolation and information purposes only.

	 <p>BUILDBLOCK BUILDING SYSTEMS, LLC Office: 405-840-3386 Toll Free: 866-222-2575 Fax: 831-597-0792 buildblock.com store.buildblock.com</p>	<p>TABLE NUMBER 12-D</p>
---	--	--

BUILDBLOCK BUILDING SYSTEMS GLOBALBLOCK ENGINEERING TABLES

MAXIMUM ALLOWABLE CLEAR SPANS FOR 6-INCH THICK SCREEN-GRID LINTELS IN LOAD-BEARING WALLS 1,2,3,4,5,6,16 ROOF CLEAR SPAN 40 FEET AND FLOOR CLEAR SPAN 32 FEET

Lintel Depth 7, <i>D</i> (in.)	Number of bars and bar size in top and bottom of lintel	Steel yield strength 8, <i>f_y</i> (psi)	Loading condition determined from Table 7.2								
			1	2		3		4		5	
			Maximum ground snow load (psf)								
			30	70	30	70	30	70	30	70	
Maximum clear span of lintel (ft-inches)											
12 ^{9,10}	Span without stirrups 13		3-0	3-2	2-6	2-7	2-5	2-4	2-3	2-1	2-0
16 ^{9,10}	Span without stirrups 13		4-1	4-5	3-6	3-8	3-5	3-3	3-1	2-11	2-10
20 ^{9,10}	Span without stirrups 13		5-1	5-7	4-6	4-8	4-4	4-2	4-0	3-8	3-8
24 ¹¹	Span without stirrups 12,13		6-1	6-9	5-6	5-8	5-3	5-1	4-10	4-6	4-6
	1 - #4	40,000	8-9	9-11	7-8	8-0	7-2	6-8	6-2	5-2	5-0
		60,000	10-9	12-2	9-4	9-9	8-9	8-1	7-6	6-4	6-2
	1 - #5	40,000	10-11	12-5	9-7	9-11	8-11	8-3	7-8	6-6	6-3
		60,000	13-4	15-1	11-8	12-1	10-10	10-1	9-4	7-10	7-8
	2 - #4 1 - #6	40,000	12-4	14-0	10-9	11-3	10-0	9-4	8-8	7-3	7-1
		60,000	16-7	18-0	14-10	15-8	13-4	12-0	10-10	8-9	8-6
	2 - #5	40,000	16-7	18-0	14-2	15-0	12-9	11-7	10-5	8-5	8-2
60,000		DR	DR	DR	DR	DR	DR	DR	DR	DR	
Center distance <i>A</i> ^{14,15}			2-5	3-1	1-10	2-0	1-7	1-5	1-2	STL	STL

1. For SI: 1 inch = 25.4 mm; 1 psf = 0.0479 kN/m²; 1 ft. = 0.3048 m; Grade 40 = 280 MPa; Grade 60 = 420 MPa. Where lintels are formed with screen-grid forms, form material shall be removed if necessary to create top and bottom flanges of the lintel that are not less than 5 inches (127 mm) in width and not less than 2.5 inches (64 mm) in depth (in the vertical direction). See Figure 7.5. Flat stay-in-place form lintels shall be permitted to be used in lieu of screen-grid lintels. See Tables 7.3 through 7.10.
2. See Table 2.1 for tolerances permitted from nominal thickness and minimum dimensions and spacings of cores.
3. Table values are based on concrete with a minimum specified compressive strength of 2,500 psi (17.2 MPa). See notes 13 and 15. Table values are based on uniform loading. See Section 7.2 for lintels supporting concentrated loads.
4. Deflection criterion is L/240, where L is the clear span of the lintel in inches, or 1/2-inch (13 mm), whichever is less.
5. Linear interpolation is permitted between ground snow loads.
6. DR indicates design required STL indicates stirrups required throughout lintel
7. Lintel depth, *D*, is permitted to include the available height of wall located directly above the lintel, provided that the increased lintel depth spans the entire length of the lintel.
8. Stirrups shall be fabricated from reinforcing bars with the same yield strength as that used for the main longitudinal reinforcement.
9. Stirrups are not required for lintels less than 24 inches (610 mm) in depth fabricated from screen-grid forms. Top and bottom reinforcement shall consist of a No. 4 bar having a yield strength of 40,000 psi (280 MPa) or 60,000 psi (420 MPa).
10. Lintels between 12 (305) and 24 inches (610 mm) in depth with stirrups shall be formed from flat-walls forms (see Tables 7.3 through 7.10), or form material shall be removed from screen-grid forms so as to provide a concrete section comparable to that required for a flat wall. Allowable spans for flat lintels with stirrups shall be determined from Tables 7.3 through 7.10.
11. Where stirrups are required for 24-inch (610 mm) deep lintels, the spacing shall not exceed 12 inches (305 mm) on center.
12. Allowable clear span without stirrups applicable to all lintels of the same depth, *D*. Top and bottom reinforcement for lintels without stirrups shall not be less than the least amount of reinforcement required for a lintel of the same depth and loading condition with stirrups. All other spans require stirrups spaced at not more than 12 inches (305 mm).
13. Where concrete with a minimum specified compressive strength of 3,000 psi (20.7 MPa) is used, clear spans for lintels without stirrups shall be permitted to be multiplied by 1.05. If the increased span exceeds the allowable clear span for a lintel of the same depth and loading condition with stirrups, the top and bottom reinforcement shall be equal to or greater than that required for a lintel of the same depth and loading condition that has an allowable clear span that is equal to or greater than that of the lintel without stirrups that has been increased.
14. Center distance, *A*, is the center portion of the span where stirrups are not required. This is applicable to all longitudinal bar sizes and steel yield strengths.
15. Where concrete with a minimum specified compressive strength of 3,000 psi (20.7 MPa) is used, center distance, *A*, shall be permitted to be multiplied by 1.10.
16. The maximum clear opening width between two solid wall segments shall be 18 feet (5.5 m). See Section 5.2.1. Lintel spans in table greater than 18 feet (5.5 m) are shown for interpolation and information purposes only.

	 <p>BUILDBLOCK BUILDING SYSTEMS, LLC Office: 405-840-3386 Toll Free: 866-222-2575 Fax: 831-597-0792 buildblock.com store.buildblock.com</p>	<p>TABLE NUMBER 12-E</p>
---	--	--



NORTH AMERICAN MANUFACTURING FACILITIES

BuildBlock Building Systems has fourteen manufacturing facilities across North America and plans to add locations for the next several years. This means we have the manufacturing capacity to meet your ICF needs now and in the future. Shorter shipping distances mean lower freight costs for you and your customers.

BuildBlock continually develops new products and technologies solving problems and meeting needs in residential, commercial, industrial, and institutional construction. We innovate with the goal of creating cost-effective techniques and products for our customers.

BuildBlock partners have facilities around the world to meet your needs including the Philippines, Cyprus, and Egypt and continue to expand. Choosing BuildBlock isn't just about choosing the best ICF block on the market, it's about finding a partner with a strong commitment to our customers, our business partners, and our industry.

CONTACT BUILDBLOCK

- ☎
866-222-2575 Toll free
🌐
buildblock.com
- ☎
405-840-3386 Office
🛒
store.buildblock.com
- ☎
831-597-0792 Fax
🎓
training.buildblock.com

SOCIAL MEDIA



MISSION

To harmoniously use the extraordinary gifts and talents of our distributors and dealers to fulfill the goals and dreams of millions of people who want to build better structures as reflected by our motto: "Build it once. Build it for life."

To manufacture one of the most affordable and highest quality Insulating Concrete Forms available in the world today.

To build greatness by providing the resources and services needed for building successful ICF businesses and sustainable ICF structures.

To build an enduring, profitable company while conducting business with Godly character, fairness and integrity.

VISION

We envision a world where BuildBlock ICF technology delivers energy-efficient, safe, healthy, comfortable and sustainable ICF homes and buildings to millions of people worldwide through the uncompromising integrity of BuildBlock's team of distributors, dealers and customers.

VALUES

INTEGRITY – We strive to balance the best interests of our distributors, dealers, customers, employees, and investors in an environment of Godly character and honesty.

EDUCATION – We seek to educate the public on the valuable benefits of ICF structures while recognizing that in order to expand the industry, we must educate installers, architects, and engineers in ICF best practices.

CUSTOMER SATISFACTION – We commit to building a team of employees that is inspired, empowered, and driven to meet the ever-changing needs of our distributors, dealers, and customers while we seek to distinguish ourselves in the marketplace by delivering exceptional customer satisfaction.

INNOVATION – We value and invest heavily in innovation while continually expanding our product line through the development of technologically advanced products.

QUALITY – We commit to producing the finest quality products. We stand by the belief that our brand embodies quality, consistency, user satisfaction, and service.

PROFITABILITY – We commit to the strong work ethic and financial prudence necessary to deliver financial results for our business partners and investors and to ensure a long-term profitable relationship.

EMPOWERMENT – We dedicate ourselves to empowering people to improve and enrich their lives and the world around them.



The day for building your walls will come, the day for extending your boundaries.