

BUILDBLOCK BUILDING SYSTEMS
BUILD SHIELD PRODUCT & INSTALLATION MANUAL
REVISED FEBRUARY 2016

BUILDSHIELD PRODUCT & INSTALLATION MANUAL

Table of Contents

Termite Limited Warranty And Disclaimer	ii
<i>Caution Sharp!</i>	<i>ii</i>
Firestop Limited Warranty And Disclaimer	ii
BuildShield Termite Barrier and BuildShield Firestop Protection	1
<i>Product Overview</i>	<i>1</i>
BuildShield Termite	3
<i>Overview</i>	<i>3</i>
Termite Installation Overview	3
<i>BuildShield Termite Components</i>	<i>3</i>
<i>Recommended Tools for Installation</i>	<i>3</i>
BuildShield Termite Installation	3
<i>Crawlspace Notes</i>	<i>7</i>
<i>Additional Installation Notes</i>	<i>7</i>
<i>BuildShield Firestop Components</i>	<i>8</i>
<i>Recommended Tools for Installation</i>	<i>8</i>
BuildShield Firestop Installation	8
<i>Additional Firestop Installation Notes</i>	<i>12</i>
<i>BuildShield Firestop Protection Installation with a Wood Joist Floor System</i>	<i>12</i>
BuildShield CAD Details	13

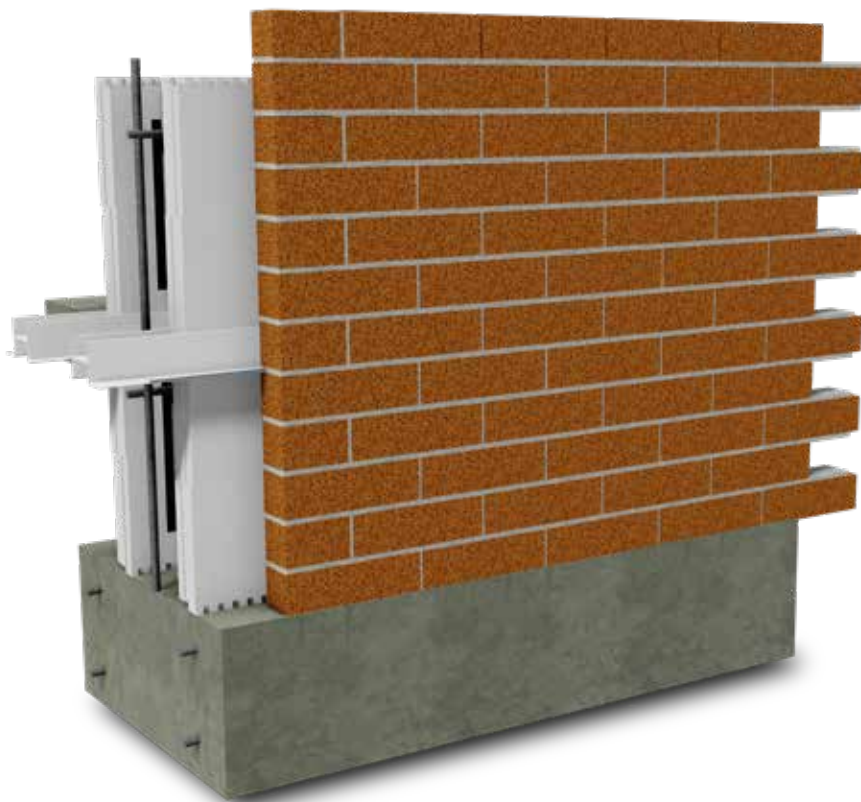

BUILDSHIELD PRODUCT & INSTALLATION MANUAL**TERMITE LIMITED WARRANTY AND DISCLAIMER**

The BuildShield barrier is intended to create a barrier to prevent termite travel vertically in an ICF wall. For a period of 5 years from installation of the BuildShield barrier, BuildBlock guarantees that termites cannot vertically pass through the BuildShield barrier when the BuildShield is properly installed by an approved contractor in accordance with prescribed installation guidelines. This limited warranty is non-transferable. In the event of a breach of this guarantee, BuildBlock agrees to repair or replace the defective BuildShield barrier. THIS STATES BUILDBLOCK'S ENTIRE LIABILITY FOR A BREACH OF THIS GUARANTEE. UNDER NO CIRCUMSTANCES SHALL BUILDBLOCK BE LIABLE FOR ANY INDIRECT, SPECIAL, PUNITIVE, INCIDENTAL OR CONSEQUENTIAL DAMAGES (INCLUDING DAMAGES CAUSED BY TERMITES OR OTHER PESTS, DAMAGES FOR LOSS OF BUSINESS PROFITS, BUSINESS INTERRUPTION, LOSS OF BUSINESS INFORMATION, AND THE LIKE) OF THE PURCHASER OR ANY OTHER THIRD PARTY, EVEN IF A PARTY HAD PREVIOUSLY BEEN ADVISED OF, OR OTHERWISE SHOULD HAVE BEEN AWARE OF, THE POSSIBILITY OF SUCH DAMAGES, AND REGARDLESS OF THE LEGAL THEORY OR BASIS FOR SUCH CLAIM. BUILDBLOCK EXPRESSLY DISCLAIMS ANY IMPLIED WARRANTIES OF MERCHANTABILITY OF THE BUILDSHIELD BARRIER PRODUCT OR FITNESS FOR A PARTICULAR PURPOSE, AND PROVIDES NO OTHER WARRANTIES OR GUARANTIES, EXPRESSED OR IMPLIED.

CAUTION SHARP!

The adhesive stainless steel barrier of the BuildShield barrier product is very thin and sharp, and will easily cut through skin and clothing if mishandled. It is imperative that installers wear proper protective clothing and gloves when installing the BuildShield barrier product. **DO NOT SLIDE HANDS ALONG THE EDGE OF THE ADHESIVE STAINLESS STEEL BARRIER OF THE BUILDSHIELD BARRIER PRODUCT.** Failure to give proper attention to these warnings or to observe these safety precautions will result in injuries. Treat all edges of the BuildShield barrier product (including scrap and cut ends) as razor-sharp, and wear proper protective clothing and gloves when handling. Extra caution must be taken when peeling the paper backing from the steel, as it is difficult to start when wearing gloves. Ensure all ends and seams are fully pressed down against the track or layers below to prevent injury when stacking the next course of ICF. All ends should be terminated at or on the vertical sides of the track, and well away from the exterior finish extension, leaving a smooth, rolled surface for other trades to encounter.

FIRESTOP LIMITED WARRANTY AND DISCLAIMER

BuildShield is intended to create a barrier to prevent hot gases and flames from travelling vertically in an ICF wall during a fire, propagating the fire from floor to floor and bypassing the designed fire resistance of floor systems. Due to the high melting point of stainless steel, flames and hot gases are blocked at the BuildShield barrier, unable to pass through the properly installed barrier. The continuity of this barrier is greatly dependent on proper installation and visual inspection throughout the installation process. There are multiple opportunities during the installation for mis handling, misapplication, and misuse, that BuildBlock has no control over. Improper installation of the adhesive stainless steel barrier, inadequate embedment of the flanges into the concrete core or incomplete termination at the floor system will enable the barrier to fall out of position, leading to a potential failure. Additionally, BuildBlock is not inspecting the installations and cannot verify proper usage. Installers should inspect the adhesive stainless steel barrier for penetrations, wrinkles or loose ends. Due to the variety of possible interpretations of the installation of this product, and the variety of local conditions, as well as application within the ICF wall system, BuildBlock provides no warranty, expressed or implied beyond the products to be free of defects in material and workmanship. Remediation is limited to replacement of the product.

**For additional information, please contact BuildBlock
Technical Support at 866-222-2575 or
email technical@buildblock.com.**

BUILDSHIELD PRODUCT & INSTALLATION MANUAL

BUILDSHIELD TERMITE BARRIER AND BUILDSHIELD FIRESTOP PROTECTION

PRODUCT OVERVIEW

BuildShield Termite and BuildShield Firestop Protection are a 2 part system consisting of a PVC extrusion and an adhesive stainless steel barrier. The combination of inedible plastic and high strength puncture resistant stainless steel creates an impenetrable barrier to termite intrusion into your home or structure.

BuildShield Firestop protection creates a barrier bridging the EPS foam at the top of a wall and between floors in ICF structures, ensuring that hot gases from a fire do not travel up the wall, preventing faster spread of the flames through the structure.



Figure 1.1 BuildShield PVC Extrusion



Figure 1.2 BuildShield Adhesive Stainless Steel

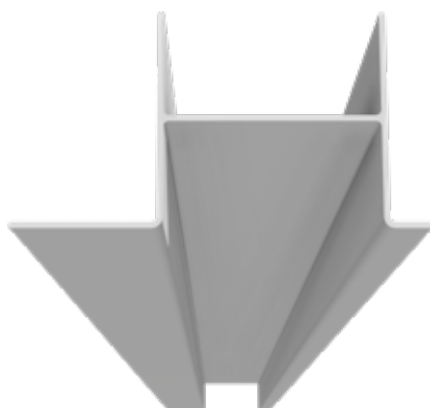

Figure 1.3 BuildShield Stainless Steel Barrier



Figure 1.4 BuildShield Stainless Steel Barrier

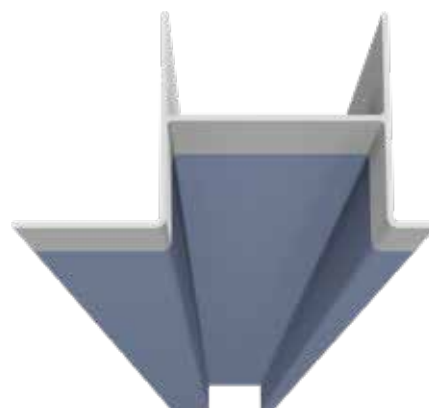

Figure 1.5 BuildShield PVC Extrusion and Stainless Steel Barrier assembled.

BUILDSHIELD PRODUCT & INSTALLATION MANUAL

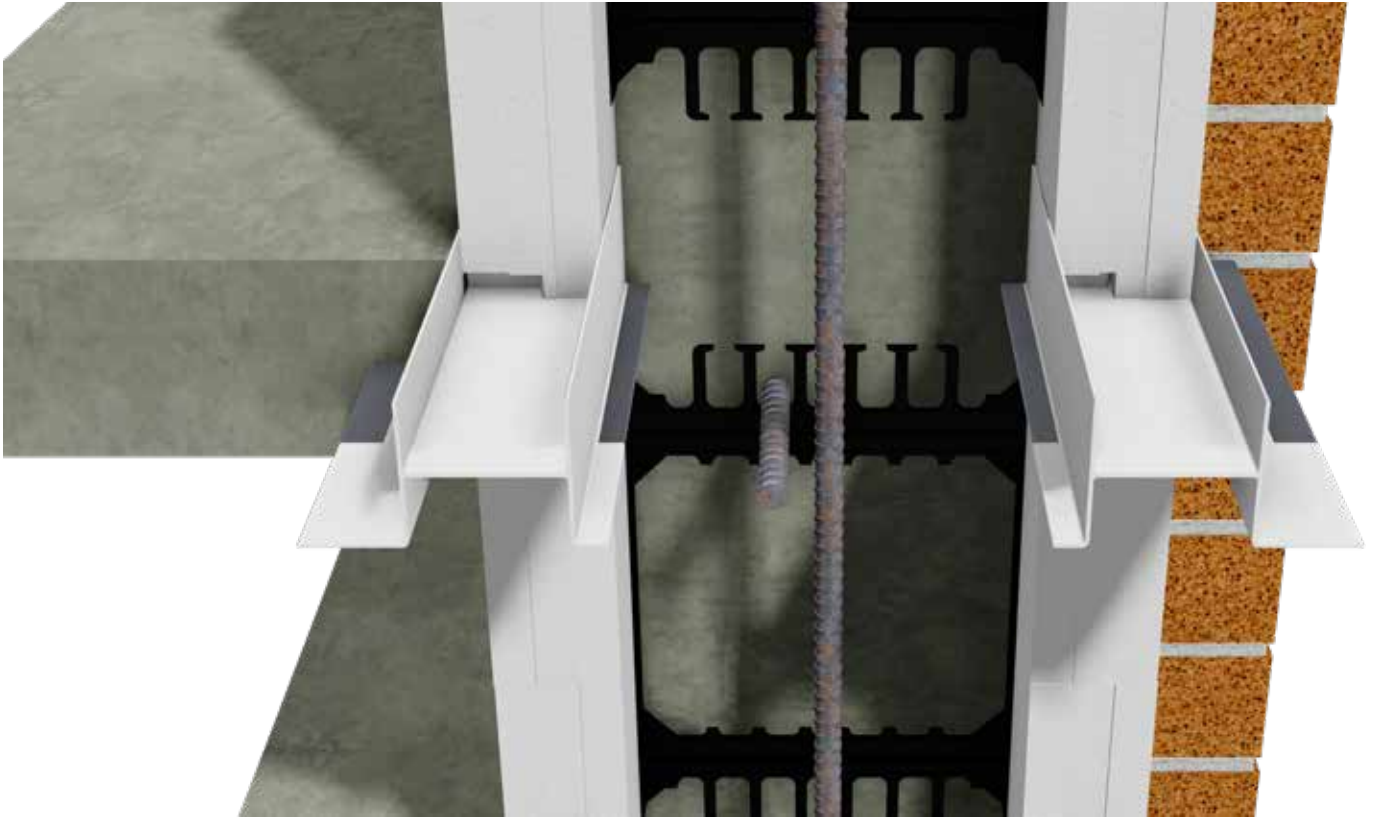

Figure 1.6 BuildShield PVC Extrusion and Stainless Steel Barrier installed into interior and exterior walls. BuildShield embeds fully into concrete slab and into brick finish and stainless steel barrier wraps around extrusion..

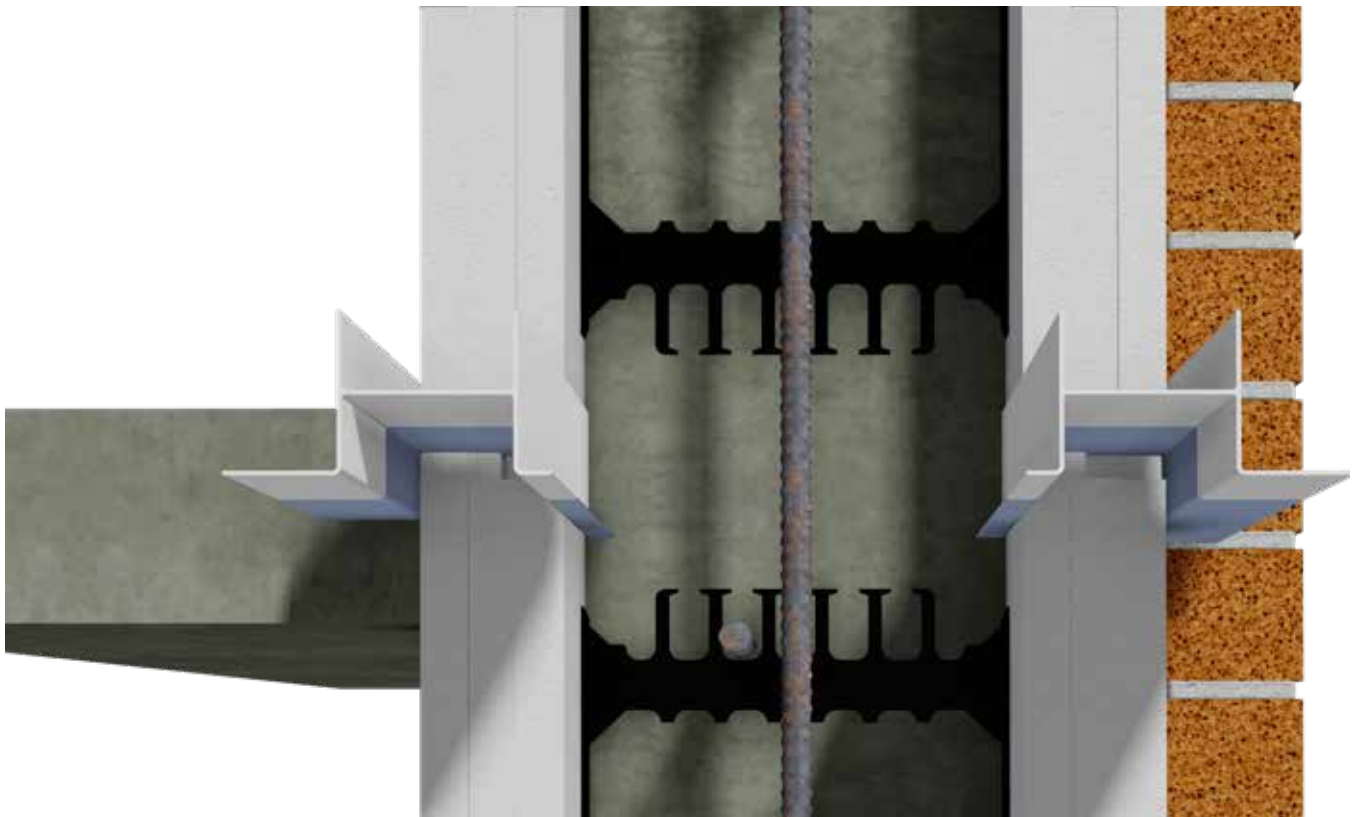

Figure 1.7 BuildShield PVC Extrusion and Stainless Steel Barrier installed into interior and exterior walls. BuildShield embeds fully into concrete slab and into brick finish. Stainless steel barrier wraps around extrusion and seals below ICF foam completely.

BUILDSHIELD PRODUCT & INSTALLATION MANUAL

BUILDSHIELD TERMITE

OVERVIEW

BuildBlock BuildShield is a 2 piece assembly, designed to prevent termites' ability to enter a home or commercial structure through an ICF wall. It has been suggested that termites may tunnel through the EPS foam to enter an ICF building. BuildShield Termite interrupts this pathway with a plastic extrusion, and an adhesive stainless steel barrier that termites cannot pass through.

Termites thrive in moist and dark environments. Properly installed, this shield will prevent termites from tunneling inside the foam, forcing them to move around the barrier. Unable to penetrate into the concrete core, they move to the outside of the finish of the structure.

Termites will protect themselves from the sun and dry air termites by build mud tubes. This tube is the first sign a termite inspector will look for when inspecting for termite activity. Through forcing termites to the outside of the wall, BuildShield Termite exposes termite activity visible and makes termite inspection quick and simple.

ICF walls may be installed over a slab on grade, and as a stem wall or crawlspace wall below grade.

TERMITE INSTALLATION OVERVIEW

NOTE: READ FULL INSTALLATION INSTRUCTIONS BEFORE BEGINNING.

BUILDSHIELD TERMITE COMPONENTS

- 16 BuildShield Extrusion Tracks (64 linear feet)
- 1 Stainless Steel Barrier Roll (64 linear feet)

RECOMMENDED TOOLS FOR INSTALLATION

- Gloves (Stainless Steel is extremely sharp)
- Miter Saw or Miter Box
- Box Knife
- Tin Snips
- Tape Measure
- Straight Edge
- Clean rags to wipe extrusion
- BuildShield Corner Template

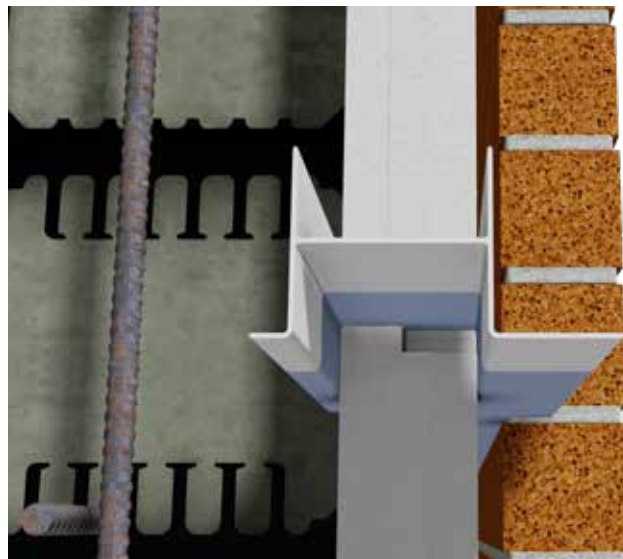
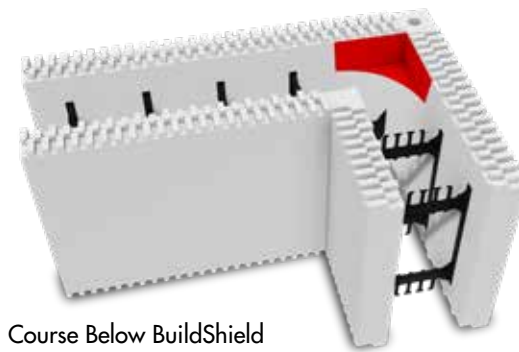

Figure 1. The BuildShield Extrusion and Stainless Steel Barrier installs between the ICF block courses at the desired height. The wide flange extends to the exterior face of the ICF block into exterior finish and the narrow flange extends into the concrete core.

BUILDSHIELD TERMITE INSTALLATION



Course Below BuildShield



Course Above BuildShield

Figure 2. Corner form modified to remove foam radius in corner for BuildShield installation. Note radius is only removed to a depth of 3". Corner form modified to remove interlock fingers and foam radius removed in corner for BuildShield Track. Note this form is placed with the modifications toward the BuildShield Extrusion Track.

BUILDSHIELD PRODUCT & INSTALLATION MANUAL

1. Begin all BuildShield installations at the corners.

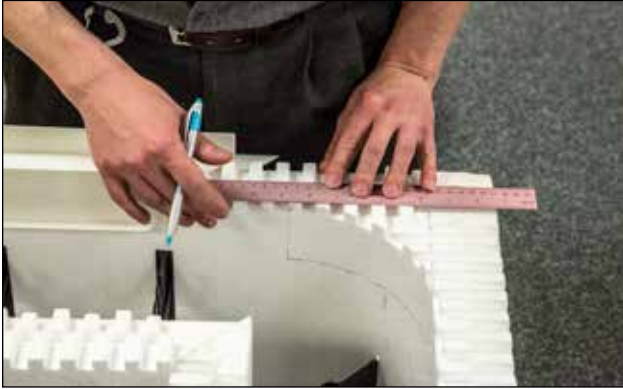

2. The corner forms immediately above and below the BuildShield installation must be prepared by cutting the internal foam radius in the corner forms to provide adequate clearance for the BuildShield extrusions. The cuts should be made 3" deep, and should maintain the panel thickness of 2-1/2" into the corner. See figure 2 above.



3. Make all cuts away from the stacked forms, to avoid filling the cores with foam pieces or beads. Ensure that the wide flange is always to the outside of the block away from the concrete core.
4. Miter cut 1 BuildShield extrusion into both edges of the corner assembly, for placement into the corner block using a miter saw, or miter table.
5. Miter joints should overlap the stainless steel barrier bond completely in each direction including the flange wherever the barriers overlap. The stainless steel barrier should be extended 2.5" past the foam panel in each direction to provide suitable material for the overlap of the flange.
6. Corner sections should be assembled before the straight runs. By cutting a single extrusion we can create a 2ft by 2ft corner section. Very short return walls will be trimmed to fit, and corners may be assembled as pairs.
7. **PUT ON SAFETY GLOVES BEFORE PROCEEDING. THE STAINLESS STEEL BARRIER IS EXTREMELY SHARP.**
8. To begin, cut the adhesive stainless steel barrier into two 2ft sections. Using the template provided cut stainless steel barrier ends, using opposite sides of template for each side of the corner. Fold the edges of the stainless steel, along the crease lines, toward the stainless steel face.



BUILDSHIELD PRODUCT & INSTALLATION MANUAL



9. Align the creased edge lines in the stainless steel barrier with the edges of the ICF form panel. Note: leave the wider portion of the barrier from the score lines to the outside face of block. The thinner portion of the barrier from the score lines to the inside core of the block. Fold the stainless steel barrier over the foam panel keeping it aligned with the creases in the stainless steel barrier and the paper backing facing up.



10. The stainless steel barriers should be fully bonded together by removing the paper backing from the bottom stainless steel barrier in the corner before bonding. Take care to avoid any bubbles or wrinkles. Completely bond each direction. Cut additional material to patch if necessary to ensure complete coverage. Ensure all top and end laps are bonded steel to steel, with no paper between.



BUILDSHIELD PRODUCT & INSTALLATION MANUAL



11. Place the mitered extrusions down over the adhesive stainless steel barrier, and align the miters at the corner.
12. Place both corner miters prior to wrapping the adhesive stainless steel barrier around the extrusion flanges.
13. Wipe the extrusion flanges clean to prepare for adhesive before proceeding to the next step.
14. The BuildShield extrusion wide flange is scored for multiple finish options. The flange should be trimmed using a box knife or other sharp knife to the correct width for your finish application. Bend the flange at this cut line and snap off the excess material. Ensure that the BuildShield wide flange extends to or past the exterior finish of the wall.
15. For brick BuildShield should extend into the mortar joint between 2 courses. The holes must be grouted full on the course above and below the BuildShield installation.
16. For stucco or EIFS, the exterior flange should be shortened to extend flush or slightly beyond thickness of the finish. Siding and other finishes may benefit from the full width of the flange to ensure easy inspections for termite mud tubes.

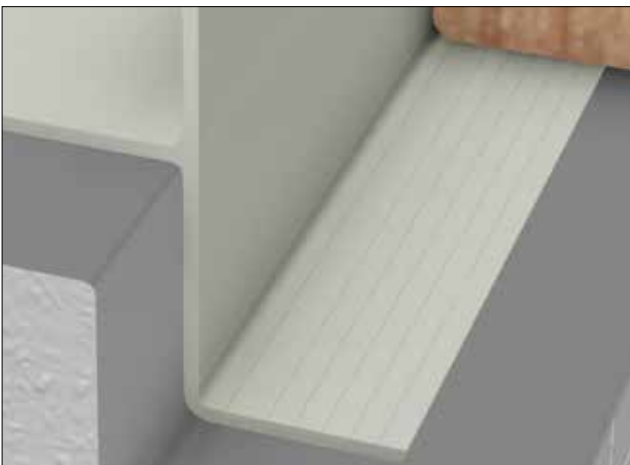

Score lines in the BuildShield Extrusion provide options for different wall finishes.

17. Caution: Wearing protective gloves is required for the next step. Serious injury will result. The stainless steel edges are very sharp and will easily cut through your hands.
18. Using a sharp razor knife, lightly score the paper at the bottom of the extrusion, and peel it back from the stainless steel, exposing the adhesive. **DO NOT PUNCTURE OR CUT STAINLESS STEEL BARRIER.** If it is cut, place a patch over the cut, extending 2" either side of cut, and bond fully to the stainless steel.



19. Begin working the adhesive against the extrusion taking special care to remove any gaps or bubbles. It helps to slide one's hands against the steel to bond the adhesive and to help bend the stainless steel barrier. Hold the extrusion down as the stainless steel is being folded under and around the flange. This is especially critical at the edges of the flanges, as the stainless steel must be formed tightly around the edge of each flange.

BUILDSHIELD PRODUCT & INSTALLATION MANUAL



20. Continue to work the stainless steel barrier onto the top of the flanges, sealing it fully in place. Carefully fold the stainless steel barrier around the extrusion flanges to ensure a tight seal around the flange radius flattening all creases and bubbles.



The stainless steel barrier wraps around the interior and exterior flange. Form a tight seal around the flange radius.

21. If BuildShield is used for a concrete floor system, ensure that the stainless steel is set so that it is fully embedded into the concrete slab. Leave at least 3/4" coverage of concrete minimum over and under the flanges.
22. Remove the BuildShield corner assembly from the forms and inspect the bottom side for gaps or holes. Patch these as required. Lay the straight runs of stainless steel barrier, allowing a 2 inch overlap to the corner assembly, and trim the backing paper to expose the adhesive. Reinstall the

corner, ensuring full contact with the exposed adhesive, and caulk the top and bottom of the mitered joint using 100% silicone.

23. Install the remaining straight sections of BuildShield, onto the stainless steel, beginning at the corner assembly.
24. Corner forms, in the course immediately above the BuildShield installation must be prepared as noted for the lower course (Item #2) prior to installing. Once the corners are stacked, begin placing the next course of straight forms.
25. When laying additional courses of blocks remove interlock fingers on the ICF form in the course above BuildShield that fits into the extrusion. If extrusions are used on both sides, you do not have to remove the fingers, but this will affect coursing height. In order to maintain coursing height, removal of the fingers is required on either the top or bottom of the block. If BuildShield is placed only on one side of the form, rasp the thickness of the BuildShield extrusion from the course with the interlocks removed to keep the wall plumb.
26. For brick BuildShield should extend into the mortar joint between 2 courses. The holes must be grouted full on the course above and below the BuildShield installation.
27. For stucco or EIFS, the exterior flange should be shortened to extend flush or slightly beyond thickness of the finish. Siding and other finishes may benefit from the full width of the flange to ensure easy inspections for termite mud tubes.

CRAWLSPACE NOTES

BuildShield may also be used under a crawlspace to allow inspection for mud tubes and other signs of termite activity. Ensure at least 4" clear space between BuildShield and floor system for visual inspection. BuildBlock recommends inspecting at least twice per year for crawlspace installations, spring and fall.

ADDITIONAL INSTALLATION NOTES

ICF blocks may need to be cut to a particular wall height to allow for proper placement of the BuildShield flange within the wall system. Typically BuildShield is installed 6-12" above grade and below windows to allow for inspection and preventing termites from entering through backfill.

When using a foam ICF buck on doors the BuildShield extrusion should extend to the inside of the foam buck on each side.

The stainless steel barrier provides a gapless seal along the length of the extrusions. Seams in the stainless steel barrier should be overlapped 2 inches. The extrusion shapes the stainless, embeds the wrapped flanges into the concrete core and the exterior wall finishes, or interior floor slab. The extrusion ensures that the barrier is properly positioned throughout the entire construction process.

When pouring walls, it is necessary to fully vibrate this area, especially corners, to ensure that concrete is properly consolidated around the flange. Additionally, slightly higher slump concrete (thinner) may be used to help ensure complete consolidation around the flanges. Do not exceed a 6" to 7" slump.

BUILDSHIELD PRODUCT & INSTALLATION MANUAL

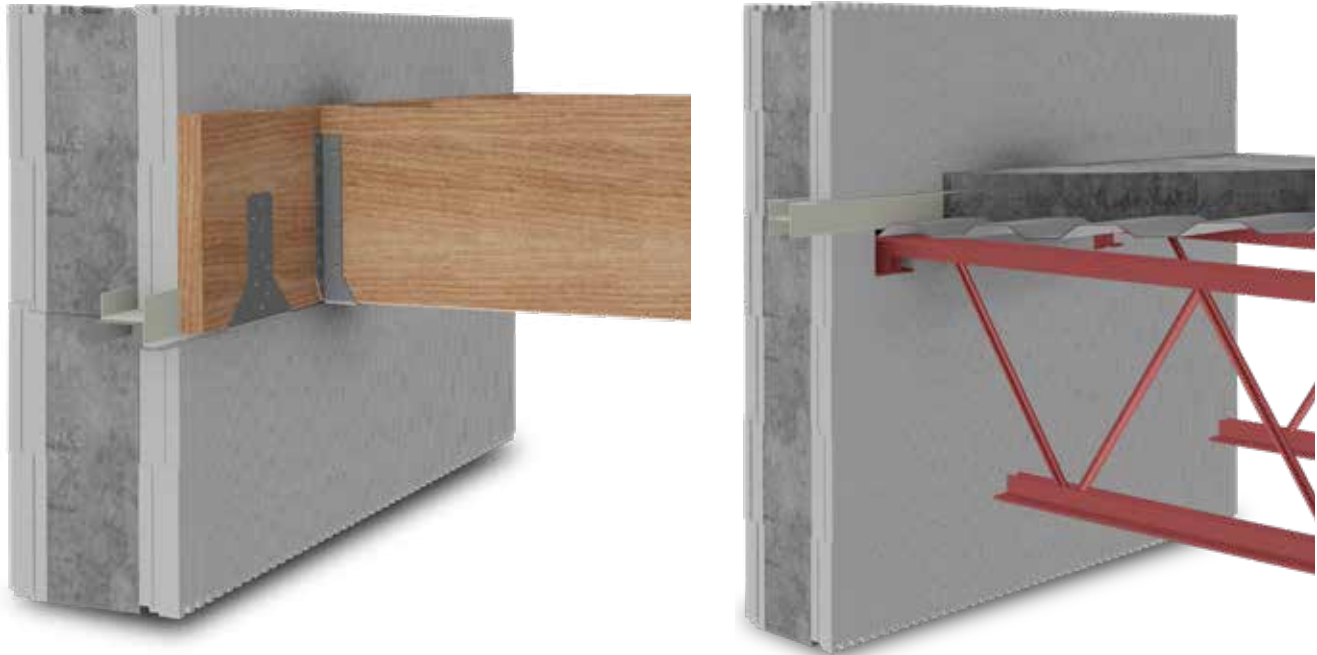

Figure 2.1 The BuildShield Extrusion and Stainless Steel Barrier installs between the ICF block courses at the desired height. The wide flange extends to the exterior face of the ICF block into interior finish and the narrow flange extends into the concrete core.

FIRESTOP INSTALLATION OVERVIEW

NOTE: READ FULL INSTALLATION INSTRUCTIONS BEFORE BEGINNING.

BUILDSHIELD FIRESTOP COMPONENTS

- 16 BuildShield Extrusion Tracks (64 linear feet)
- 1 Stainless Steel Barrier Roll (64 linear feet)

RECOMMENDED TOOLS FOR INSTALLATION

- Gloves (Stainless Steel is extremely sharp)
- Miter Saw or Miter Box
- Box Knife
- Tin Snips
- Tape Measure
- Straight Edge
- Clean rags to wipe extrusion
- BuildShield Corner Template



BUILDSHIELD FIRESTOP INSTALLATION

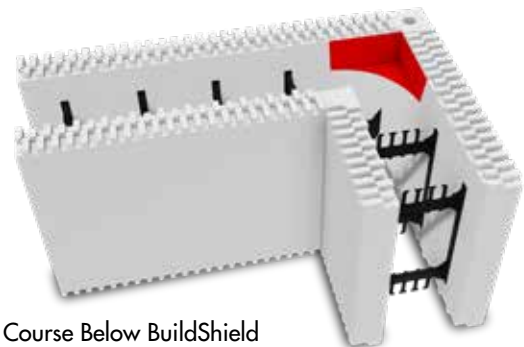

Course Below BuildShield



Course Above BuildShield

Figure 2.2 Corner form modified to remove foam radius in corner for BuildShield installation. Note radius is only removed to a depth of 3". Corner form modified to remove interlock fingers and foam radius removed in corner for BuildShield installation. Note this form is placed with the modifications toward the BuildShield Extrusion Track.

BUILDSHIELD PRODUCT & INSTALLATION MANUAL

1. Begin all BuildShield installations at the corners.

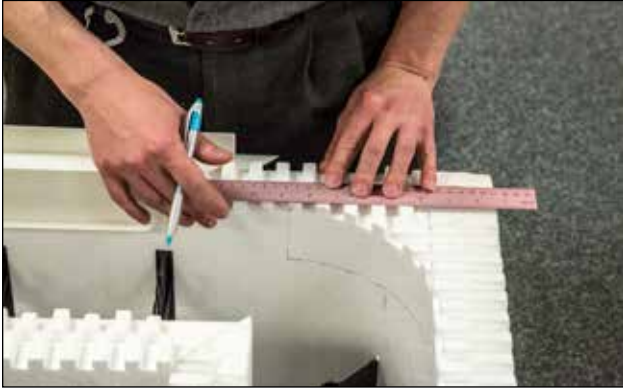

2. The corner forms immediately above and below the BuildShield installation must be prepared by cutting the internal foam radius in the corner forms to provide adequate clearance for the BuildShield extrusions. The cuts should be made 3" deep, and should maintain the panel thickness of 2-1/2" into the corner. See figure 2 above.



3. Make all cuts away from the stacked forms, to avoid filling the cores with foam pieces or beads. Ensure that the wide flange is always to the outside of the block away from the concrete core.
4. Miter cut 1 BuildShield extrusion into both edges of the corner assembly, for placement into the corner block using a miter saw, or miter table.
5. Miter joints should overlap the stainless steel barrier bond completely in each direction including the flange wherever the barriers overlap. The stainless steel barrier should be extended 2.5" past the foam panel in each direction to provide suitable material for the overlap of the flange.
6. Corner sections should be assembled before the straight runs. By cutting a single extrusion we can create a 2ft by 2ft corner section. Very short return walls will be trimmed to fit, and corners may be assembled as pairs.
7. **PUT ON SAFETY GLOVES BEFORE PROCEEDING. THE STAINLESS STEEL BARRIER IS EXTREMELY SHARP.**
8. To begin, cut the adhesive stainless steel barrier into two 2ft sections. Using the template provided cut stainless steel barrier ends, using opposite sides of template for each side of the corner. Fold the edges of the stainless steel, along the crease lines, toward the stainless steel face.



BUILDSHIELD PRODUCT & INSTALLATION MANUAL



9. Align the creased edge lines in the stainless steel barrier with the edges of the ICF form panel. Note: leave the wider portion of the barrier from the score lines to the outside face of block. The thinner portion of the barrier from the score lines to the inside core of the block. Fold the stainless steel barrier over the foam panel keeping it aligned with the creases in the stainless steel barrier and the paper backing facing up.



10. The stainless steel barriers should be fully bonded together by removing the paper backing from the bottom stainless steel barrier in the corner before bonding. Take care to avoid any bubbles or wrinkles. Completely bond each direction. Cut additional material to patch if necessary to ensure complete coverage. Ensure all top and end laps are bonded steel to steel, with no paper between.



11. Place the mitered extrusions down over the adhesive stainless steel barrier, and align the miters at the corner.
12. Place both corner miters prior to wrapping the adhesive stainless steel barrier around the extrusion flanges.
13. Wipe the extrusion flanges clean to prepare for adhesive before proceeding to the next step.
14. The BuildShield extrusion wide flange is scored for multiple finish options. The flange should be trimmed using a box knife or other sharp knife to the correct width for your finish application. Bend the flange at this cut line and snap off the excess material. Ensure that the BuildShield wide flange extends to or past the exterior finish of the wall.
15. For brick BuildShield should extend into the mortar joint between 2 courses. The holes must be grouted full on the course above and below the BuildShield installation.

BUILDSHIELD PRODUCT & INSTALLATION MANUAL

16. For stucco or EIFS, the exterior flange should be shortened to extend flush or slightly beyond thickness of the finish. Siding and other finishes may benefit from the full width of the flange to ensure easy inspections for termite mud tubes.

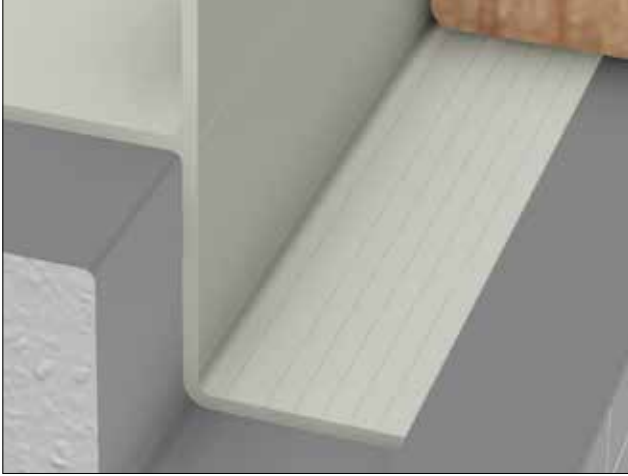

Score lines in the BuildShield Extrusion provide options for different wall finishes.

17. Caution: Wearing protective gloves is required for the next step. Serious injury will result. The stainless steel edges are very sharp and will easily cut through your hands.
18. Using a sharp razor knife, lightly score the paper at the bottom of the extrusion, and peel it back from the stainless steel, exposing the adhesive. **DO NOT PUNCTURE OR CUT STAINLESS STEEL BARRIER.** If it is cut, place a patch over the cut, extending 2" either side of cut, and bond fully to the stainless steel.



19. Begin working the adhesive against the extrusion taking special care to remove any gaps or bubbles. It helps to slide one's hands against the steel to bond the adhesive and to help bend the stainless steel barrier. Hold the extrusion down as the stainless steel is being folded under and around the flange. This is especially critical at the edges of the flanges, as the stainless steel must be formed tightly around the edge of each flange.



20. Continue to work the stainless steel barrier onto the top of the flanges, sealing it fully in place. Carefully fold the stainless steel barrier around the extrusion flanges to ensure a tight seal around the flange radius flattening all creases and bubbles.

BUILDSHIELD PRODUCT & INSTALLATION MANUAL



The stainless steel barrier wraps around the interior and exterior flange. Form a tight seal around the flange radius.

21. If BuildShield is used for a concrete floor system, ensure that the stainless steel is set so that it is fully embedded into the concrete slab. Leave at least 3/4" coverage of concrete minimum over and under the flanges.
22. Remove the BuildShield corner assembly from the forms and inspect the bottom side for gaps or holes. Patch these as required. Lay the straight runs of stainless steel barrier, allowing a 2 inch overlap to the corner assembly, and trim the backing paper to expose the adhesive. Reinstall the corner, ensuring full contact with the exposed adhesive, and caulk the top and bottom of the mitered joint using 100% silicone.
23. Install the remaining straight sections of BuildShield, onto the stainless steel, beginning at the corner assembly.
24. Corner forms, in the course immediately above the BuildShield installation must be prepared as noted for the lower course (Item #2) prior to installing. Once the corners are stacked, begin placing the next course of straight forms.
25. When laying additional courses of blocks remove interlock fingers on the ICF form in the course above BuildShield that fits into the extrusion. If extrusions are used on both sides, you do not have to remove the fingers, but this will affect coursing height. In order to maintain coursing height, removal of the fingers is required on either the top or bottom of the block. If BuildShield is placed only on one side of the form, rasp the thickness of the BuildShield extrusion from the course with the interlocks removed to keep the wall plumb.
26. For brick BuildShield should extend into the mortar joint between 2 courses. The holes must be grouted full on the course above and below the BuildShield installation.
27. For stucco or EIFS, the exterior flange should be shortened to extend flush or slightly beyond thickness of the finish. Siding and other finishes may benefit from the full width of the flange to ensure easy inspections for termite mud tubes.

ADDITIONAL FIRESTOP INSTALLATION NOTES

ICF blocks may need to be cut to a particular wall height to allow for proper placement of the BuildShield flange within the wall system.

The stainless steel barrier provides a gapless seal along the length of the extrusions. Seams in the stainless steel barrier should be overlapped 2 inches. The extrusion shapes the stainless, embeds the wrapped flanges into the concrete core and the exterior wall finishes, or interior floor slab. The extrusion ensures that the barrier is properly positioned throughout the entire construction process.

When pouring walls, it is necessary to fully vibrate this area, especially corners, to ensure that concrete is properly consolidated around the flange. Additionally, slightly higher slump concrete (thinner) may be used to help ensure complete consolidation around the flanges. Do not exceed a 6" to 7" slump.

Mechanical attachments such as pan head screws should be placed through the stainless steel barrier into the wood or steel joists at 12'o.c. This will prevent the barrier from sagging during a fire.



The BuildShield stainless steel barrier wraps around the extrusion track. The stainless steel barrier extends under the edge of the rim joist. Screw from the underside every 12" to ensure stainless steel barrier remains in place during a fire.

BUILDSHIELD FIRESTOP PROTECTION INSTALLATION WITH A WOOD JOIST FLOOR SYSTEM

BuildShield should be installed to extend below the joist or be sandwiched between horizontal members within the floor system. It is important for BuildShield to be mechanically affixed to the rim joists, either with screws (12"o.c. max) or other means, to prevent adhesive release during a fire. BuildShield is designed to prevent the chimney effect at the foam on the inside of the ICF.

1. BuildShield Firestop should be placed so that the flanges align with the top or bottom of a joist type floor system.
2. BuildShield Firestop should not be installed such that the flange is cut flush with the EPS, and aligning in the center of the rim joist.
3. The stainless steel barrier must have no holes, gaps, bubbles or wrinkles. If necessary, cut small pieces of stainless steel barrier to create patches.
4. Overlap should be 2" minimum at all seams and patches.
5. Mechanical attachments such as pan head screws should be placed through the stainless steel barrier into the wood or steel rim joists at 12'o.c. This will prevent the barrier from sagging during a fire.

BUILDSHIELD TERMITE AND BUILDSHIELD FIRESTOP PROTECTION ARE A 2 PART SYSTEM CONSISTING OF A PVC EXTRUSION AND AN ADHESIVE STAINLESS STEEL BARRIER. THE COMBINATION OF INEDIBLE PLASTIC AND HIGH STRENGTH PUNCTURE RESISTANT STAINLESS STEEL CREATES AN IMPENETRABLE BARRIER TO TERMITE INTRUSION INTO YOUR HOME OR STRUCTURE.

BUILDSHIELD FIRESTOP PROTECTION CREATES A BARRIER BRIDGING THE EPS FOAM AT THE TOP OF A WALL AND BETWEEN FLOORS IN ICF STRUCTURES, ENSURING THAT HOT GASES FROM A FIRE DO NOT TRAVEL UP THE WALL, PREVENTING FASTER SPREAD OF THE FLAMES THROUGH THE STRUCTURE.

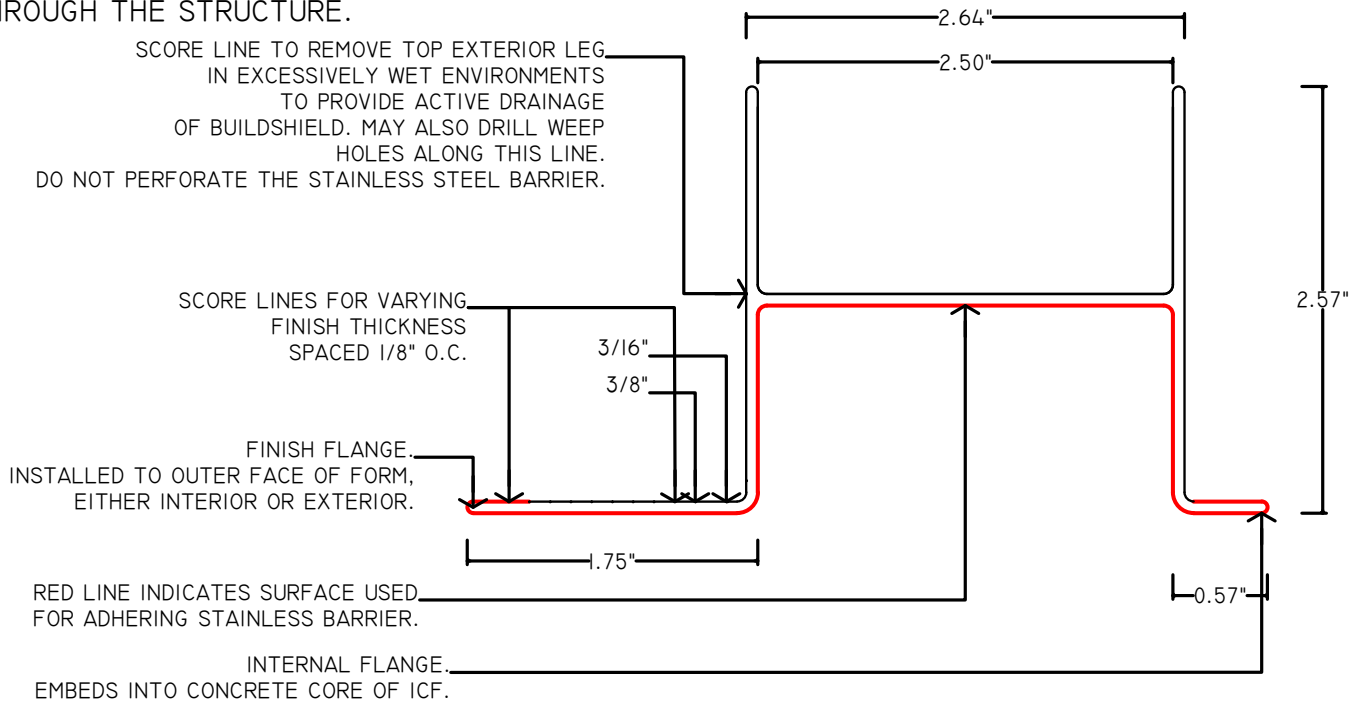

THE STAINLESS STEEL BARRIER PROVIDES A GAPLESS SEAL ALONG THE LENGTH OF THE EXTRUSION. SEAMS IN THE STAINLESS STEEL BARRIER SHOULD BE OVERLAPPED 2 INCHES. THE EXTRUSION SHAPES THE STAINLESS STEEL BARRIER EMBEDDING THE WRAPPED FLANGES INTO THE CONCRETE CORE, EXTERIOR WALL FINISHES, OR INTERIOR FLOOR SLAB. THE EXTRUSION ENSURES THAT THE BARRIER IS PROPERLY POSITIONED THROUGHOUT THE ENTIRE CONSTRUCTION PROCESS.

	BUILDSHIELD PRODUCT DETAIL				
	DATE/REV	12/2015	SCALE	NTS	DETAIL SHEET
	NOTES				63A
OFFICE: 405-840-3386 TOLL FREE: 866-222-2575 FAX: 831-597-0792 BUILDBLOCK.COM	CONSTRUCTION SHALL BE IN ACCORDANCE WITH ALL APPLICABLE LOCAL AND NATIONAL CODES. ALL DRAWINGS ARE SUBJECT TO CHANGE WITHOUT NOTICE.				

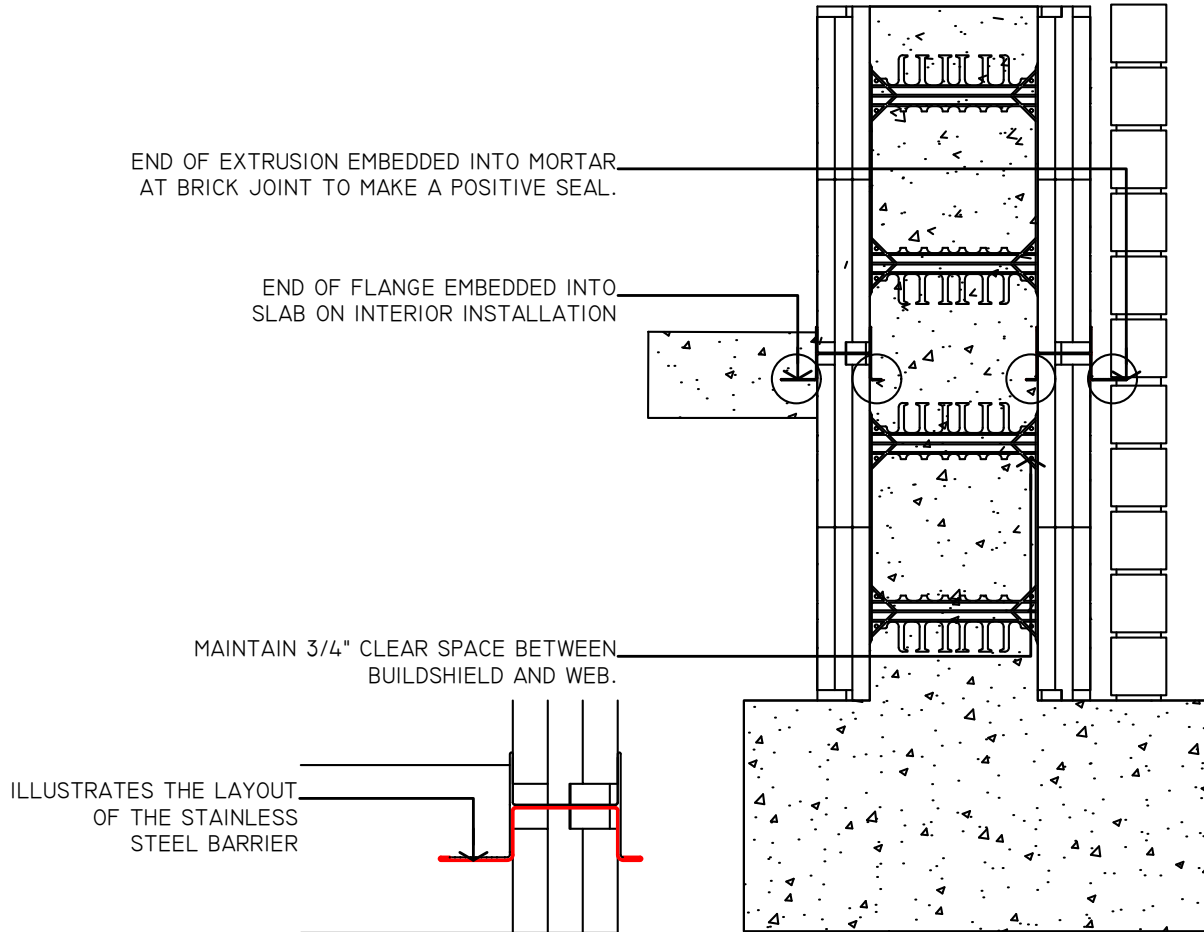



BUILDSHIELD TERMITE INSTALLATION

1. STACK ICF FORMS TO THE HEIGHT REQUIRED FOR PLACEMENT OF THE BUILDSHIELD TERMITE PROTECTION.
2. PRE-CUT ICF CORNER FORMS AS SHOWN IN DETAIL 63C FOR USE WITH BUILDSHIELD. TO ENSURE THE EXTRUSION WILL FIT COMPLETELY INTO THE CORNER OF THE FORM.
3. MITER CUT 2 EXTRUSIONS INTO THE CORNER BLOCK USING A MITER SAW, OR MITER TABLE. ENSURE THAT THE WIDE FLANGE IS TO THE OUTSIDE FACE OF THE BLOCK AWAY FROM THE CONCRETE CORE.
4. ROLL OUT THE ADHESIVE STAINLESS STEEL BARRIER ONTO THE TOP OF THE FORMS. LEAVE 2-1/2" OF TAPE EXTENDING OUT FROM THE EDGES OF THE CORNER BLOCK. ROLL OUT PLENTY OF STAINLESS BARRIER TO WORK WITH.
5. ALIGN THE CREASED EDGE LINES IN THE STAINLESS STEEL BARRIER WITH THE EDGES OF THE ICF FORM PANEL. NOTE: LEAVE THE WIDER PORTION OF THE BARRIER FROM THE SCORE LINES TO THE OUTSIDE FACE OF BLOCK. THE THINNER PORTION OF THE BARRIER FROM THE SCORE LINES TO THE INSIDE CORE OF THE BLOCK.
6. STARTING AT A CORNER, PLACE THE MITERED EXTRUSIONS DOWN OVER THE ADHESIVE STAINLESS STEEL BARRIER, WORKING DOWN THE WALL.
7. PLACE ALL EXTRUSIONS PRIOR TO WRAPPING THE ADHESIVE STAINLESS STEEL BARRIER AROUND THE EXTRUSION FLANGES.
8. WIPE THE EXTRUSION FLANGES CLEAN TO PREPARE FOR ADHESIVE BEFORE PROCEEDING TO THE NEXT STEP .
9. USING A SHARP RAZOR KNIFE, LIGHTLY SCORE THE PAPER AT THE BOTTOM OF THE EXTRUSION, AND PEEL IT BACK FROM THE STAINLESS STEEL, EXPOSING THE ADHESIVE. DO NOT PUNCTURE OR CUT STAINLESS STEEL. IF IT IS CUT, PLACE A PATCH OVER THE CUT, EXTENDING 2" EITHER SIDE OF CUT, AND BOND FULLY TO THE STAINLESS STEEL.
10. CAUTION: WEARING PROTECTIVE GLOVES IS A NECESSITY FOR THE NEXT STEP. SERIOUS INJURY WILL RESULT. THE STAINLESS STEEL EDGES ARE VERY SHARP AND WILL EASILY CUT THROUGH YOUR HANDS.
11. BEGIN WORKING THE ADHESIVE AGAINST THE EXTRUSION TAKING SPECIAL CARE TO REMOVE ANY GAPS OR BUBBLES. IT HELPS TO SLIDE ONE'S HANDS AGAINST THE STEEL TO BOND THE ADHESIVE AND TO HELP BEND THE STAINLESS STEEL BARRIER. HOLD THE EXTRUSION DOWN AS THE STAINLESS STEEL IS BEING FOLDED UNDER AND AROUND THE FLANGE. THIS IS ESPECIALLY CRITICAL AT THE EDGES OF THE FLANGES, AS THE STAINLESS STEEL MUST BE FORMED TIGHTLY AROUND THE SMALL RADIUS.
12. CONTINUE TO WORK THE STAINLESS STEEL BARRIER ONTO THE TOP OF THE FLANGES, SEALING IT FULLY IN PLACE.
13. WHEN LAPPING STAINLESS STEEL AT CORNERS, REMOVE THE PAPER BACKING FROM THE STAINLESS STEEL BARRIER ON BOTTOM TO FULLY ADHERE IT TO THE STAINLESS STEEL ABOVE WHERE THE BARRIERS OVERLAP. TAKE CARE TO ENSURE THAT ALL STAINLESS STEEL IS LAPPED AND BONDED AT THE CORNER TO ELIMINATE ANY GAPS. SMALL PIECES OF BARRIER MAY BE CUT TO COVER ANY REMAINING GAPS. COMPLETE COVERAGE OF THE BARRIER IS ESSENTIAL AT THE CORNERS.
14. IF BUILDSHIELD IS BEING INSTALLED WITH THE STAINLESS ABOVE THE EXTRUSION, ENSURE PROPER ORIENTATION OF THE EXTRUSION, AND PLACE IT ON TOP OF THE COURSE. FOLD THE STAINLESS STEEL BARRIER AT THE CREASES TO EASE PLACEMENT OF THE ICF FORMS, AND INSERT INTO THE EXTRUSION. PLACE THE TOP ICF FORM INTO THE EXTRUSION, INSIDE THE STAINLESS STEEL BARRIER, AND FOLLOW STEPS ABOVE FOR SCORING THE PAPER AND ADHERING THE STAINLESS TO THE EXTRUSION, WORKING FROM THE ICF TO THE BOTTOM SIDE OF THE FLANGES.
15. IF BUILDSHIELD IS USED FOR A CONCRETE FLOOR SYSTEM, ENSURE THAT THE STAINLESS STEEL IS SET SO THAT IT IS FULLY EMBEDDED INTO THE CONCRETE SLAB. LEAVE AT LEAST 3/4" COVERAGE OF CONCRETE MINIMUM OVER AND UNDER THE FLANGES.
16. ENSURE THAT BUILDSHIELD EXTENDS TO OR PAST THE EXTERIOR FINISH OF THE WALL. FOR BRICK BUILDSHIELD SHOULD EXTEND INTO THE MORTAR JOINT BETWEEN 2 COURSES. THE HOLES MUST BE GROUTED FULL ON THE COURSE ABOVE AND BELOW THE BUILDSHIELD INSTALLATION. FOR STUCCO OR EIFS, THE EXTERIOR FLANGE SHOULD BE SHORTENED TO EXTEND FLUSH OR SLIGHTLY BEYOND THE FINISH THICKNESS OF THE FINISH. SIDING AND OTHER FINISHES MAY BENEFIT FROM THE FULL LENGTH OF THE FLANGE TO ENSURE EASY INSPECTIONS FOR TERMITE MUD TUBES.
17. NOTE: ICF BLOCKS MAY NEED TO BE CUT TO A PARTICULAR WALL HEIGHT TO ALLOW FOR PROPER PLACEMENT OF THE BUILDSHIELD FLANGE WITHIN THE WALL SYSTEM.
18. REMOVE INTERLOCK FINGERS ON THE ICF FORM IN THE COURSE ABOVE BUILDSHIELD THAT FITS INTO THE EXTRUSION. IF EXTRUSIONS ARE USED ON BOTH SIDES, YOU DO NOT HAVE TO REMOVE THE FINGERS, BUT THIS WILL AFFECT COURSING HEIGHT. IN ORDER TO MAINTAIN COURSING HEIGHT, REMOVAL OF THE FINGERS IS REQUIRED. IF BUILDSHIELD IS PLACED ONLY ON ONE SIDE OF THE FORM, RASP THE THICKNESS OF THE BUILDSHIELD EXTRUSION FROM THE COURSE WITH THE INTERLOCKS REMOVED TO KEEP THE WALL PLUMB.
19. NOTE: BUILDSHIELD MAY ALSO BE USED UNDER A CRAWLSPACE IN ORDER TO ALLOW INSPECTION FOR MUD TUBES AND OTHER SIGNS OF TERMITE ACTIVITY. ENSURE AT LEAST 4" CLEAR SPACE BETWEEN BUILDSHIELD AND FLOOR SYSTEM FOR VISUAL INSPECTION. BUILDBLOCK RECOMMENDS INSPECTING AT LEAST TWICE PER YEAR FOR CRAWLSPACE INSTALLATIONS, SPRING AND FALL.

	BUILDSHIELD TERMITE INSTALLATION				
	DATE/REV	12/2015	SCALE	NTS	DETAIL SHEET
	NOTES				63B
OFFICE: 405-840-3386 TOLL FREE: 866-222-2575 FAX: 831-597-0792 BUILDBLOCK.COM					CONSTRUCTION SHALL BE IN ACCORDANCE WITH ALL APPLICABLE LOCAL AND NATIONAL CODES. ALL DRAWINGS ARE SUBJECT TO CHANGE WITHOUT NOTICE.

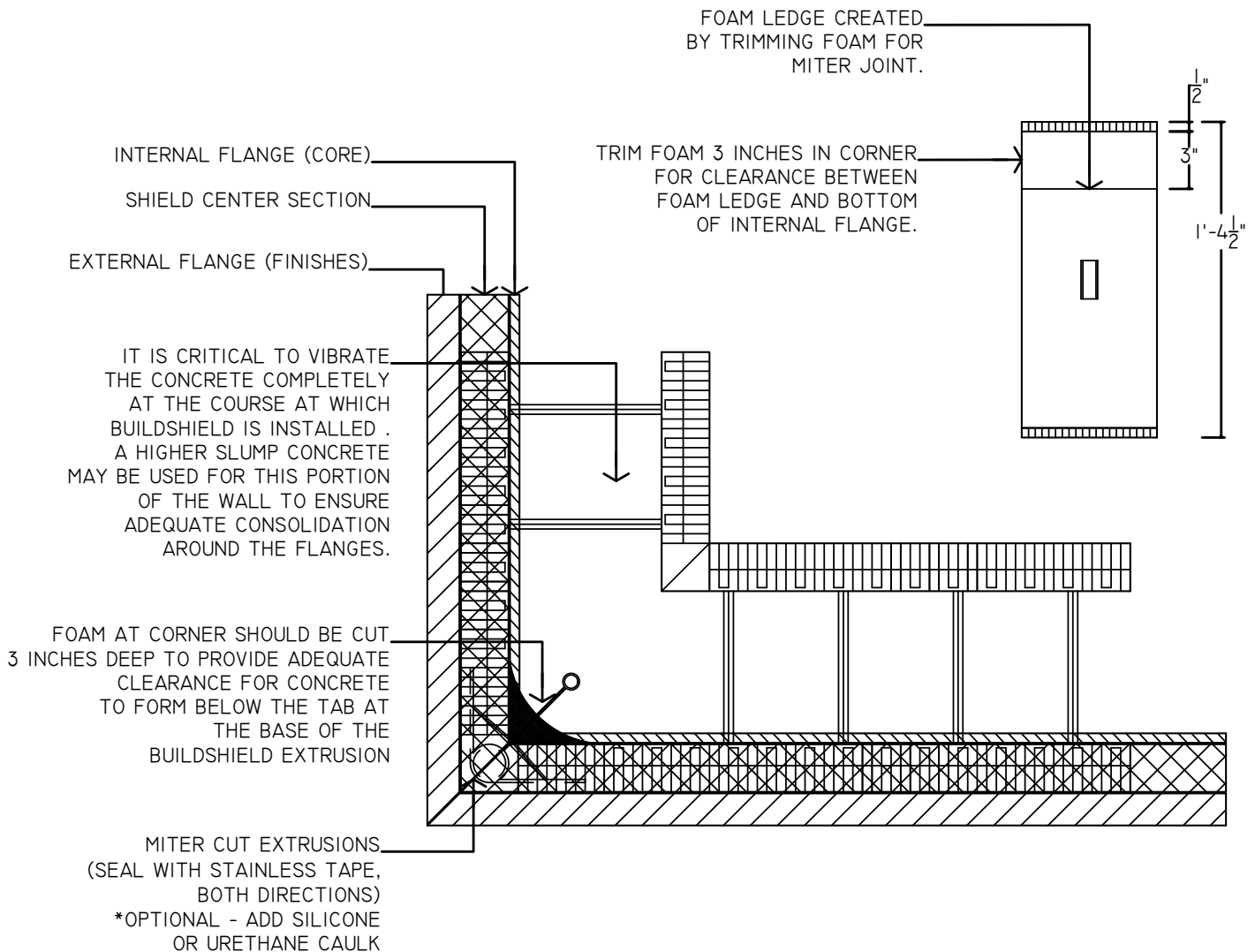
1. BEGIN ALL BUILDSHIELD INSTALLATIONS AT THE CORNERS.
2. THE CORNER FORMS IMMEDIATELY ABOVE AND BELOW THE BUILDSHIELD INSTALLATION MUST BE PREPARED PRIOR TO INSTALLING BUILDSHIELD.
3. THE INTERNAL FOAM RADIUS IN THE CORNER FORMS SHOULD BE CUT OUT TO PROVIDE ADEQUATE CLEARANCE FOR BUILDSHIELD EXTRUSIONS. THE CUTS SHOULD BE MADE 3" DEEP, AND SHOULD MAINTAIN THE PANEL THICKNESS AT 2-1/2" INTO THE CORNER.
4. MAKE ALL CUTS AWAY FROM THE STACKED FORMS, TO AVOID FILLING THE CORES WITH FOAM PIECES OR BEADS.
5. BUILDSHIELD EXTRUSIONS SHOULD HAVE A MITER CUT, MADE ON A MITER SAW OR IN A MITER BOX.
6. MITER JOINTS SHOULD HAVE STAINLESS STEEL BARRIERS OVERLAP FROM EACH DIRECTION, AND BARRIERS SHOULD BE FULLY BONDED TOGETHER, BY REMOVING THE ADHESIVE PAPER FROM THE BOTTOM BARRIER. TAKE CARE TO AVOID ANY BUBBLES OR WRINKLES. READ FULL INSTALLATION INSTRUCTIONS BEFORE BEGINNING.
7. WHEN POURING WALLS, IT IS NECESSARY TO FULLY VIBRATE THIS AREA, TO ENSURE THAT CONCRETE IS PROPERLY CONSOLIDATED AROUND THE FLANGE. ADDITIONALLY, SLIGHTLY HIGHER SLUMP CONCRETE (THINNER) MAY BE USED TO HELP ASSURE COMPLETE CONSOLIDATION AROUND THE FLANGES. DO NOT EXCEED A 6" TO 7" SLUMP.



	BUILDSHIELD CORNER FORM MODIFICATION			DETAIL SHEET
	DATE/REV	12/2015	SCALE	NTS
	NOTES			
OFFICE: 405-840-3386 TOLL FREE: 866-222-2575 FAX: 831-597-0792 BUILDBLOCK.COM	CONSTRUCTION SHALL BE IN ACCORDANCE WITH ALL APPLICABLE LOCAL AND NATIONAL CODES. ALL DRAWINGS ARE SUBJECT TO CHANGE WITHOUT NOTICE.			63C

BUILDSHIELD INSTALLATION CONCRETE FLOOR SYSTEM

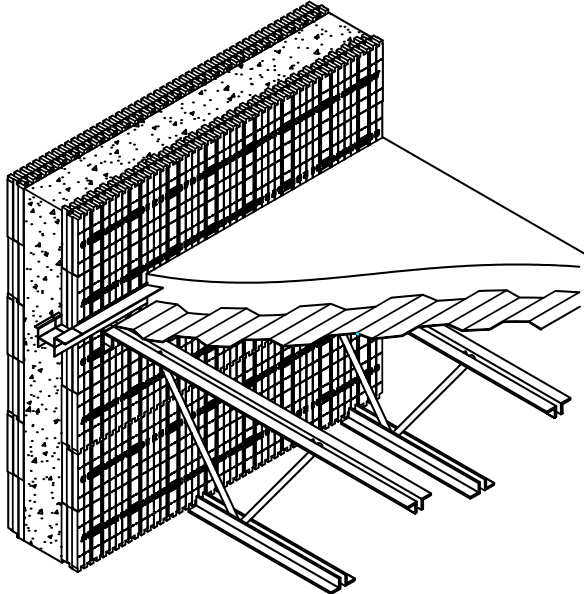

BUILDSHIELD INSTALLATION JOIST TYPE FLOOR SYSTEM

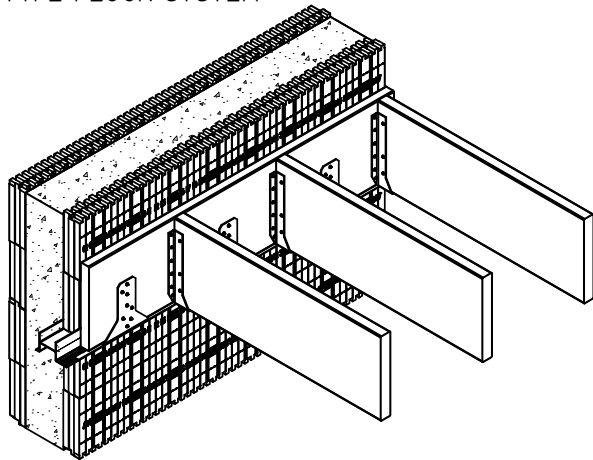

BUILDSHIELD FIRESTOP INSTALLATION

1. STACK ICF FORMS TO THE HEIGHT REQUIRED FOR PLACEMENT OF THE BUILDSHIELD FIRESTOP.
2. PRE-CUT ICF CORNER FORMS AS SHOWN IN DETAIL 63C FOR USE WITH BUILDSHIELD, TO ENSURE THE EXTRUSION WILL FIT COMPLETELY INTO THE CORNER OF THE FORM.
3. MITER CUT 2 EXTRUSIONS INTO THE CORNER BLOCK USING A MITER SAW, OR MITER TABLE. ENSURE THAT THE WIDE FLANGE IS TO THE OUTSIDE FACE OF THE BLOCK AWAY FROM THE CONCRETE CORE.
4. ROLL OUT THE ADHESIVE STAINLESS STEEL BARRIER ONTO THE TOP OF THE FORMS. LEAVE 2" OF TAPE EXTENDING OUT FROM THE EDGES OF THE CORNER BLOCK. ROLL OUT PLENTY OF STAINLESS BARRIER TO WORK WITH.
5. ALIGN THE CREASED EDGE LINES IN THE STEEL WITH THE EDGES OF THE ICF FORM PANEL. NOTE: LEAVE THE WIDER PORTION OF THE BARRIER FROM THE SCORE LINES TO THE OUTSIDE FACE OF BLOCK. THE THINNER PORTION OF THE BARRIER FROM THE SCORE LINES TO THE INSIDE CORE OF THE BLOCK.
6. STARTING AT A CORNER, PLACE THE MITERED EXTRUSION DOWN OVER THE ADHESIVE STAINLESS STEEL BARRIER, WORKING DOWN THE WALL.
7. PLACE ALL EXTRUSIONS PRIOR TO WRAPPING THE ADHESIVE STAINLESS STEEL BARRIER AROUND THE EXTRUSION FLANGES.
8. WIPE THE EXTRUSION FLANGES CLEAN TO PREPARE FOR ADHESIVE BEFORE PROCEEDING TO THE NEXT STEP .
9. USING A SHARP RAZOR KNIFE, LIGHTLY SCORE THE PAPER AT THE BOTTOM OF THE EXTRUSION, AND PEEL IT BACK FROM THE STAINLESS STEEL, EXPOSING THE ADHESIVE. DO NOT PUNCTURE OR CUT STAINLESS STEEL. IF IT IS CUT, PLACE A PATCH OVER THE CUT, EXTENDING 2" EITHER SIDE OF CUT, AND BOND FULLY TO THE STAINLESS STEEL.
10. CAUTION: WEARING PROTECTIVE GLOVES IS A NECESSITY FOR THE NEXT STEP. SERIOUS INJURY WILL RESULT. THE STAINLESS STEEL EDGES ARE VERY SHARP AND WILL EASILY CUT THROUGH YOUR HANDS.
11. BEGIN WORKING THE ADHESIVE AGAINST THE EXTRUSION TAKING SPECIAL CARE TO REMOVE ANY GAPS OR BUBBLES. IT HELPS TO SLIDE ONE'S HANDS AGAINST THE STEEL TO BOND THE ADHESIVE AND TO HELP BEND THE STAINLESS STEEL BARRIER. HOLD THE EXTRUSION DOWN AS THE STAINLESS STEEL IS BEING FOLDED UNDER AND AROUND THE FLANGE. THIS IS ESPECIALLY CRITICAL AT THE EDGES OF THE FLANGES, AS THE STAINLESS STEEL MUST BE FORMED TIGHTLY AROUND THE SMALL RADIUS.
12. CONTINUE TO WORK THE STAINLESS STEEL BARRIER ONTO THE TOP OF THE FLANGES, SEALING IT FULLY IN PLACE.
13. WHEN LAPPING STAINLESS STEEL AT CORNERS, REMOVE THE PAPER BACKING FROM THE STAINLESS STEEL BARRIER ON BOTTOM TO FULLY ADHERE IT TO THE STAINLESS STEEL ABOVE WHERE THE BARRIERS OVERLAP. TAKE CARE TO ENSURE THAT ALL STAINLESS STEEL IS LAPPED AND BONDED AT THE CORNER TO ELIMINATE ANY GAPS. SMALL PIECES OF BARRIER MAY BE CUT TO COVER ANY REMAINING GAPS. COMPLETE COVERAGE OF THE BARRIER IS ESSENTIAL AT THE CORNERS.
14. IF BUILDSHIELD IS BEING INSTALLED WITH THE STAINLESS ABOVE THE EXTRUSION, ENSURE PROPER ORIENTATION OF THE EXTRUSION, AND PLACE IT ON TOP OF THE COURSE. FOLD THE STAINLESS STEEL BARRIER AT THE CREASES TO EASE PLACEMENT OF THE ICF FORMS, AND INSERT INTO THE EXTRUSION. PLACE THE TOP ICF FORM INTO THE EXTRUSION, INSIDE THE STAINLESS STEEL BARRIER, AND FOLLOW STEPS ABOVE FOR SCORING THE PAPER AND ADHERING THE STAINLESS TO THE EXTRUSION, WORKING FROM THE ICF TO THE BOTTOM SIDE OF THE FLANGES.
15. IF BUILDSHIELD IS USED FOR A CONCRETE FLOOR SYSTEM, ENSURE THAT THE STAINLESS STEEL IS SET SO THAT IT IS FULLY EMBEDDED INTO THE CONCRETE SLAB. LEAVE AT LEAST 1/2" COVERAGE OF CONCRETE MINIMUM OVER AND UNDER THE FLANGES.
16. ENSURE THAT BUILDSHIELD EXTENDS TO OR PAST THE EXTERIOR FINISH OF THE WALL. FOR BRICK BUILDSHIELD SHOULD EXTEND INTO THE MORTAR JOINT BETWEEN 2 COURSES. THE HOLES MUST BE GROUTED FULL ON THE COURSE ABOVE AND BELOW THE BUILDSHIELD INSTALLATION. FOR STUCCO OR EIFS, THE EXTERIOR FLANGE SHOULD BE SHORTENED TO EXTEND FLUSH OR SLIGHTLY BEYOND THE FINISH THICKNESS OF THE FINISH. SIDING AND OTHER FINISHES MAY BENEFIT FROM THE FULL LENGTH OF THE FLANGE TO ENSURE EASY INSPECTIONS FOR TERMITE MUD TUBES.
17. NOTE: ICF BLOCKS MAY NEED TO BE CUT TO A PARTICULAR WALL HEIGHT TO ALLOW FOR PROPER PLACEMENT OF THE BUILDSHIELD FLANGE WITHIN THE WALL SYSTEM.
18. REMOVE INTERLOCK FINGERS ON THE ICF FORM IN THE COURSE ABOVE BUILDSHIELD THAT FITS INTO THE EXTRUSION. IF EXTRUSIONS ARE USED ON BOTH SIDES, YOU DO NOT HAVE TO REMOVE THE FINGERS, BUT THIS WILL AFFECT COURSING HEIGHT. IN ORDER TO MAINTAIN COURSING HEIGHT, REMOVAL OF THE FINGERS IS REQUIRED. IF BUILDSHIELD IS PLACED ONLY ON ONE SIDE OF THE FORM, RASP THE THICKNESS OF THE BUILDSHIELD EXTRUSION FROM THE COURSE WITH THE INTERLOCK REMOVED TO KEEP THE WALL PLUMB.
19. MECHANICAL ATTACHMENTS SUCH AS PAN HEAD SCREWS SHOULD BE PLACED THROUGH THE STAINLESS STEEL BARRIER INTO THE WOOD OR STEEL JOISTS AT 12"O.C. THIS WILL PREVENT THE BARRIER FROM SAGGING DURING A FIRE.

	BUILDSHIELD FIRESTOP INSTALLATION				
	DATE/REV	12/2015	SCALE	NTS	DETAIL SHEET
	NOTES				63D
OFFICE: 405-840-3386 TOLL FREE: 866-222-2575 FAX: 831-597-0792 BUILDBLOCK.COM					CONSTRUCTION SHALL BE IN ACCORDANCE WITH ALL APPLICABLE LOCAL AND NATIONAL CODES. ALL DRAWINGS ARE SUBJECT TO CHANGE WITHOUT NOTICE.

1. BUILDSHIELD FIRESTOP SHOULD BE PLACED SO THAT THE FLANGES ALIGN WITH THE TOP OR BOTTOM OF A JOIST TYPE FLOOR SYSTEM.
2. BUILDSHIELD FIRESTOP SHOULD NOT BE INSTALLED SUCH THAT THE FLANGE IS CUT FLUSH WITH THE EPS, AND ALIGNING IN THE CENTER OF THE RIM JOIST.
3. THE STAINLESS STEEL BARRIER MUST HAVE NO HOLES, GAPS, BUBBLES OR WRINKLES. IF NECESSARY, CUT SMALL PIECES OF STAINLESS STEEL BARRIER TO CREATE PATCHES.
4. OVERLAP SHOULD BE 2" MINIMUM AT ALL SEAMS AND PATCHES.

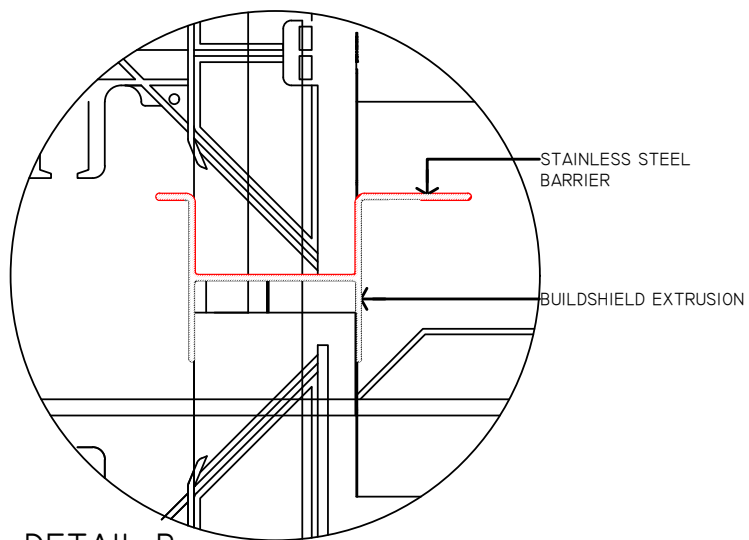

DETAIL B

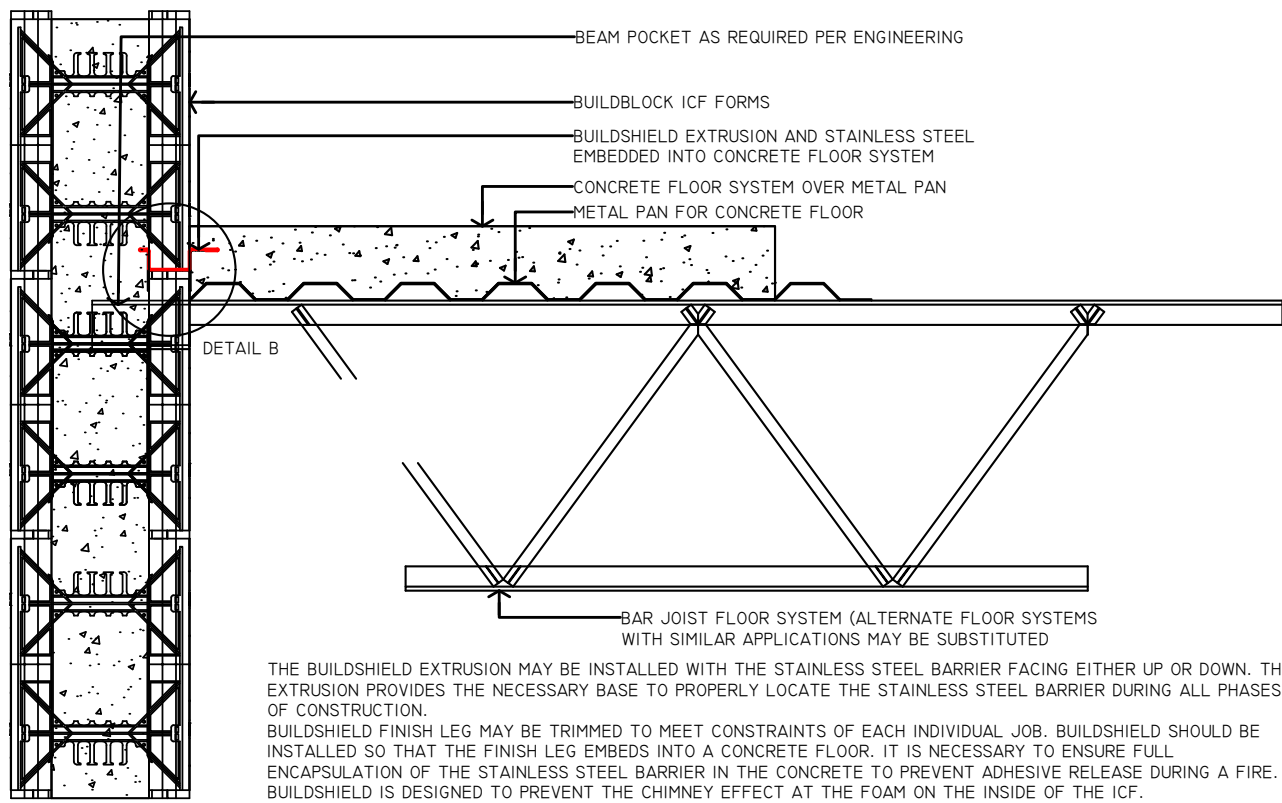

THE BUILDSHIELD EXTRUSION MAY BE INSTALLED WITH THE STAINLESS STEEL BARRIER FACING EITHER UP OR DOWN. THE EXTRUSION PROVIDES THE NECESSARY BASE TO PROPERLY LOCATE THE STAINLESS STEEL BARRIER DURING ALL PHASES OF CONSTRUCTION.

BUILDSHIELD FINISH LEG MAY BE TRIMMED TO MEET CONSTRAINTS OF EACH INDIVIDUAL JOB. BUILDSHIELD SHOULD BE INSTALLED SO THAT THE FINISH LEG EMBEDS INTO A CONCRETE FLOOR. IT IS NECESSARY TO ENSURE FULL ENCAPSULATION OF THE STAINLESS STEEL BARRIER IN THE CONCRETE TO PREVENT ADHESIVE RELEASE DURING A FIRE. BUILDSHIELD IS DESIGNED TO PREVENT THE CHIMNEY EFFECT AT THE FOAM ON THE INSIDE OF THE ICF.

	BUILDSHIELD FIRESTOP CONCRETE FLOOR SYSTEM				
	DATE/REV	12/2015	SCALE	NTS	DETAIL SHEET
	NOTES				63E
OFFICE: 405-840-3386 TOLL FREE: 866-222-2575 FAX: 831-597-0792 BUILDBLOCK.COM	CONSTRUCTION SHALL BE IN ACCORDANCE WITH ALL APPLICABLE LOCAL AND NATIONAL CODES. ALL DRAWINGS ARE SUBJECT TO CHANGE WITHOUT NOTICE.				

1. BUILDSHIELD FIRESTOP SHOULD BE PLACED SO THAT THE FLANGES ALIGN WITH THE TOP OR BOTTOM OF A JOIST TYPE FLOOR SYSTEM.
2. BUILDSHIELD FIRESTOP SHOULD NOT BE INSTALLED SUCH THAT THE FLANGE IS CUT FLUSH WITH THE EPS, AND ALIGNING IN THE CENTER OF THE RIM JOIST.
3. THE STAINLESS STEEL BARRIER MUST HAVE NO HOLES, GAPS, BUBBLES OR WRINKLES. IF NECESSARY, CUT SMALL PIECES OF STAINLESS STEEL BARRIER TO CREATE PATCHES.
4. OVERLAP SHOULD BE 2" MINIMUM AT ALL SEAMS AND PATCHES.
5. MECHANICAL ATTACHMENTS SUCH AS PAN HEAD SCREWS SHOULD BE PLACED THROUGH THE STAINLESS STEEL BARRIER INTO THE WOOD OR STEEL RIM JOISTS AT 12' O.C. THIS WILL PREVENT THE BARRIER FROM SAGGING DURING A FIRE. SEE DETAIL A.

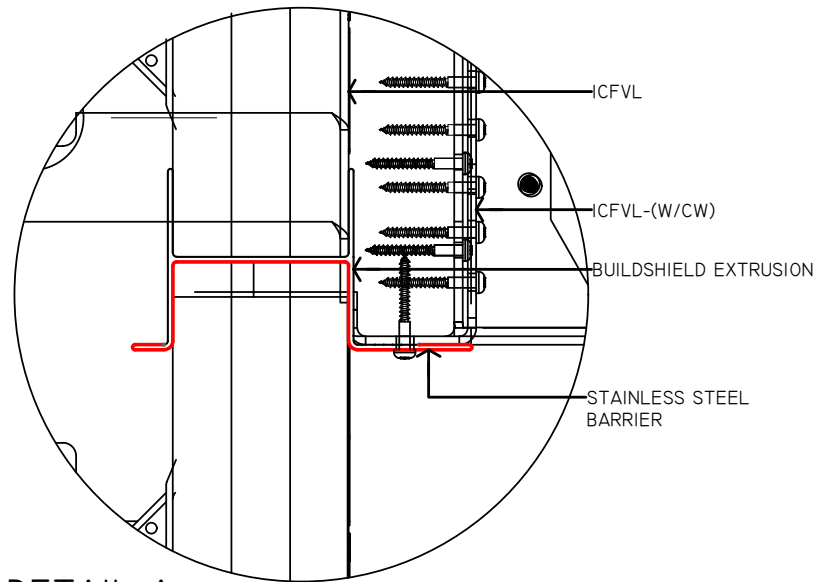

DETAIL A

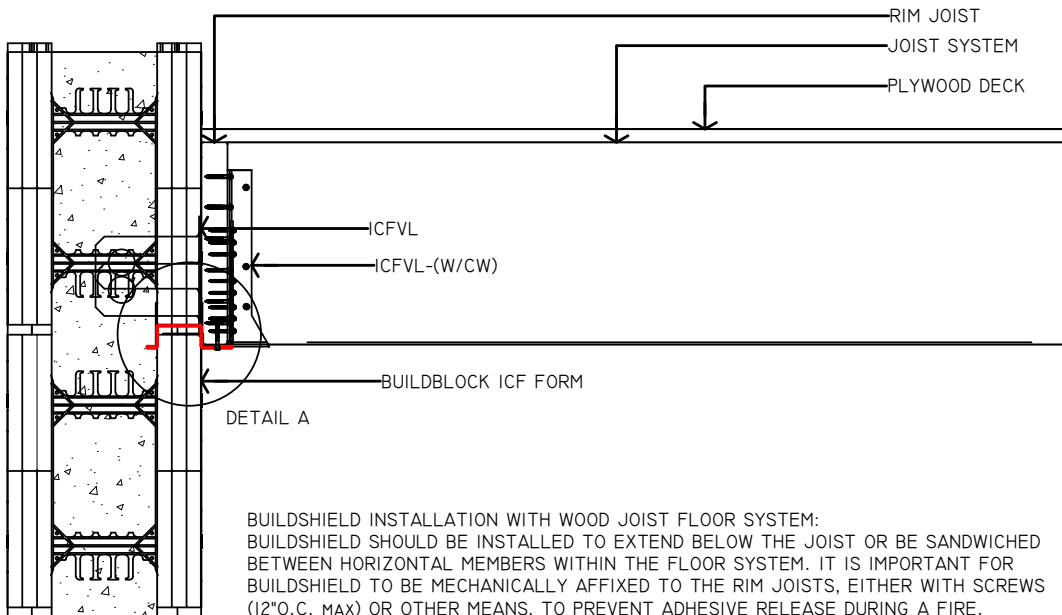

DETAIL A

BUILDSHIELD INSTALLATION WITH WOOD JOIST FLOOR SYSTEM:
 BUILDSHIELD SHOULD BE INSTALLED TO EXTEND BELOW THE JOIST OR BE SANDWICHED BETWEEN HORIZONTAL MEMBERS WITHIN THE FLOOR SYSTEM. IT IS IMPORTANT FOR BUILDSHIELD TO BE MECHANICALLY AFFIXED TO THE RIM JOISTS, EITHER WITH SCREWS (12" O.C. MAX) OR OTHER MEANS, TO PREVENT ADHESIVE RELEASE DURING A FIRE. BUILDSHIELD IS DESIGNED TO PREVENT THE CHIMNEY EFFECT AT THE FOAM ON THE INSIDE OF THE ICF.



BUILDSHIELD FIRESTOP WITH WOOD/METAL FLOOR SYSTEM

DATE/REV	12/2015	SCALE	NTS	DETAIL SHEET
----------	---------	-------	-----	--------------

NOTES

CONSTRUCTION SHALL BE IN ACCORDANCE WITH ALL APPLICABLE LOCAL AND NATIONAL CODES. ALL DRAWINGS ARE SUBJECT TO CHANGE WITHOUT NOTICE.

63F



NORTH AMERICAN MANUFACTURING FACILITIES

BuildBlock Building Systems has fourteen manufacturing facilities across North America and plans to add locations for the next several years. This means we have the manufacturing capacity to meet your ICF needs now and in the future. Shorter shipping distances mean lower freight costs for you and your customers.

BuildBlock continually develops new products and technologies solving problems and meeting needs in residential, commercial, industrial, and institutional construction. We innovate with the goal of creating cost-effective techniques and products for our customers.

BuildBlock partners have facilities around the world to meet your needs including the Philippines, Cyprus, and Egypt and continue to expand. Choosing BuildBlock isn't just about choosing the best ICF block on the market, it's about finding a partner with a strong commitment to our customers, our business partners, and our industry.

CONTACT BUILDBLOCK

☎ 866-222-2575 Toll free	🌐 buildblock.com
☎ 405-840-3386 Office	🛒 store.buildblock.com
☎ 831-597-0792 Fax	🎓 training.buildblock.com

SOCIAL MEDIA



MISSION

To harmoniously use the extraordinary gifts and talents of our distributors and dealers to fulfill the goals and dreams of millions of people who want to build better structures as reflected by our motto: "Build it once. Build it for life."

To manufacture one of the most affordable and highest quality Insulating Concrete Forms available in the world today.

To build greatness by providing the resources and services needed for building successful ICF businesses and sustainable ICF structures.

To build an enduring, profitable company while conducting business with Godly character, fairness and integrity.

VISION

We envision a world where BuildBlock ICF technology delivers energy-efficient, safe, healthy, comfortable and sustainable ICF homes and buildings to millions of people worldwide through the uncompromising integrity of BuildBlock's team of distributors, dealers and customers.

VALUES

INTEGRITY – We strive to balance the best interests of our distributors, dealers, customers, employees, and investors in an environment of Godly character and honesty.

EDUCATION – We seek to educate the public on the valuable benefits of ICF structures while recognizing that in order to expand the industry, we must educate installers, architects, and engineers in ICF best practices.

CUSTOMER SATISFACTION – We commit to building a team of employees that is inspired, empowered, and driven to meet the ever-changing needs of our distributors, dealers, and customers while we seek to distinguish ourselves in the marketplace by delivering exceptional customer satisfaction.

INNOVATION – We value and invest heavily in innovation while continually expanding our product line through the development of technologically advanced products.

QUALITY – We commit to producing the finest quality products. We stand by the belief that our brand embodies quality, consistency, user satisfaction, and service.

PROFITABILITY – We commit to the strong work ethic and financial prudence necessary to deliver financial results for our business partners and investors and to ensure a long-term profitable relationship.

EMPOWERMENT – We dedicate ourselves to empowering people to improve and enrich their lives and the world around them.

The day for building your walls will come, the day for extending your boundaries.

Micah 7:11