



BUILDBLOCK BUILDING SYSTEMS
BUILDDECK ROOF & FLOOR DECKING SYSTEM
DESIGN, ENGINEERING, AND INSTALLATION MANUAL

REVISED MAY 2016



BUILDDECK ROOF & FLOOR DECKING SYSTEM DESIGN, ENGINEERING, AND INSTALLATION MANUAL

Table of Contents

BUILDDECK ROOF & FLOOR DECKING SYSTEM DESIGN, ENGINEERING, AND INSTALLATION MANUAL.....	V
Disclaimer.....	v
Introduction.....	1
<i>Preface</i>	1
<i>Product Warnings</i>	1
<i>Trademarks</i>	1
<i>Introduction</i>	1
<i>Warranty</i>	1
SECTION 1: PRODUCT FEATURES.....	2
1.1 BuildDeck product design.....	2
1.2 Product Specifications Overview.....	3
SECTION 2: RECOMMENDED TOOLS AND ACCESSORIES.....	3
SECTION 3: ESTIMATING BUILDDECK.....	3
3.1 Estimating BuildDeck Panels.....	3
3.3 Estimating Rebar.....	4
<i>Recommended BuildDeck Shoring Design</i>	4
<i>High Load/ Reusable BuildDeck Shoring Design</i>	4
3.5 Engineering Statements.....	4
SECTION 4: BUILDDECK INSTALLATION.....	16
4.1 Wall Installation.....	16
4.2 Interior Wall Panel Height.....	16
4.3 Cut Interior Panel.....	16
4.4 Utility Angle Placement.....	17
4.5 Vertical Girder Supports Placement.....	17
4.6 Girder Placement.....	17
4.7 Joist Placement.....	17
4.8 Deck Panel Placement.....	18
4.9 Reinforcement Placement.....	18
4.10 Utilities Placement.....	19
4.11 Pre-Pour Checklist.....	20
4.12 Concrete Placement.....	20
SECTION 5: BUILDDECK SHORING REMOVAL.....	21
5.1 Shoring Removal Overview.....	21
5.2 Interior Finish Attachment.....	21
SECTION 6: BUILDDECK CAD DETAILS.....	24
<i>BuildDeck 8"</i>	25
<i>BuildDeck 10"</i>	26
<i>BuildDeck 12"</i>	27
<i>BuildDeck 12" + 2" Foam Top Hat</i>	28



BUILDDECK ROOF & FLOOR DECKING SYSTEM DESIGN, ENGINEERING, AND INSTALLATION MANUAL

<i>BuildDeck 12" + 4" Foam Top Hat</i>	29
<i>BuildDeck 12" + 6" Foam Top Hat</i>	30
<i>BuildDeck 12" + 8" Foam Top Hat</i>	31
<i>BuildDeck long span stirrups</i>	32
<i>BuildDeck Safe Room Wall section detail</i>	33
SECTION 7: BUILDDECK ENGINEERING	34
BuildDeck Shoring Engineering.....	35
<i>BuildDeck Shoring Detail</i>	41
BuildDeck 8" Engineering	42
<i>BuildDeck 8" +2" Concrete Cap Table</i>	42
<i>BuildDeck 8" +2" Concrete Cap Chart</i>	43
<i>BuildDeck 8" +3" Concrete Cap Table</i>	44
<i>BuildDeck 8" +3" Concrete Cap Chart</i>	45
<i>BuildDeck 8" +4" Concrete Cap Table</i>	46
BuildDeck 10" Engineering	47
<i>BuildDeck 8" +4" Concrete Cap Chart</i>	47
<i>BuildDeck 10" +2" Concrete Cap Table</i>	48
<i>BuildDeck 10" +2" Concrete Cap Chart</i>	49
<i>BuildDeck 10" +3" Concrete Cap Table</i>	50
<i>BuildDeck 10" +3" Concrete Cap Chart</i>	51
<i>BuildDeck 10" +4" Concrete Cap Table</i>	52
<i>BuildDeck 10" +4" Concrete Cap Chart</i>	53
BuildDeck 12" Engineering	54
<i>BuildDeck 12" +2" Concrete Cap Table</i>	54
<i>BuildDeck 12" +2" Concrete Cap Chart</i>	55
<i>BuildDeck 12" +3" Concrete Cap Table</i>	56
<i>BuildDeck 12" +3" Concrete Cap Chart</i>	57
<i>BuildDeck 12" +4" Concrete Cap Table</i>	58
<i>BuildDeck 12" +4" Concrete Cap Chart</i>	59
<i>BuildDeck 12+2 Top Hat +2" Concrete Table</i>	60
<i>BuildDeck 12" +2 Top Hat +2" Concrete Cap Chart</i>	61
<i>BuildDeck 12" +2" EPS Top Hat +3" Concrete Cap Table</i>	62
<i>BuildDeck 12" +2" EPS Top Hat +3" Concrete Cap Chart</i>	63
<i>BuildDeck 12" +2" EPS Top Hat +4" Concrete Cap Table</i>	64
<i>BuildDeck 12" +2" EPS Top Hat +4" Concrete Cap Chart</i>	65
<i>BuildDeck 12" +4" EPS Top Hat +4" Concrete Cap Table</i>	66
<i>BuildDeck 12" +6" EPS Top Hat +4" Concrete Cap Table</i>	67
<i>BuildDeck 12" +8" EPS Top Hat +4" Concrete Cap Table</i>	68

BUILDDECK ROOF & FLOOR DECKING SYSTEM DESIGN, ENGINEERING, AND INSTALLATION MANUAL

DISCLAIMER

Though every reasonable effort has been made to ensure the accuracy and relevance of the information contained in this design manual, BuildBlock Building Systems, LLC, our partners and affiliates assume no responsibility or liability for damages, failure or otherwise adverse results related to or resulting from information contained herein.

All tables, charts, pictures, descriptions and/or any other components depicted in this manual are intended to be used for estimation purposes only, and in no way are intended to be, or shall be interpreted as construction plans or approved Engineered documents.

All final design of concrete, reinforcement, shoring, system elements and interfaces are the responsibility of the project specific Engineer of Record for each application.

This system is designed to be used with the design advice and oversight of a professional trained in structural design and engineering.

Elements of this Manual has been reviewed for accuracy by:

Advanced Structural Engineering II
1265 South Semoran Boulevard, Suite 250
Winter Park, FL 32792

Long Span Tables Developed by:

McLaren Engineering Group
5728 Major Boulevard, Suite 603
Orlando, FL 32819

INTRODUCTION

PREFACE

This version of the BuildDeck Installation Manual was originally published in July 2015. Changes to this document, however, may occur without notice and users should contact BuildBlock Building Systems, LLC for the most current printed or downloadable version at buildblock.com. It is the purchaser's and/or contractor's responsibility to always use the most current and up-to-date version of the installation manual when installing BuildDeck Roof & Floor Decking System panels and/or products.

This manual was designed to be used as a reference guide only. All figures, calculations, designs, drawings, pictures and references thereto are provided as examples. All installations must be designed and approved by the project specific Engineer of Record. This manual is not intended to be used as a replacement or substitute for the actual training by an experienced and trained BuildBlock building professional. Before starting any project, BuildBlock recommends that you receive proper training. BuildBlock also recommends that you consult with a design professional trained in the discipline and familiar with the type and scope of project to be built. Training is available by contacting BuildBlock Building Systems, LLC at buildblock.com or 866-222-2575.

BuildBlock Building Systems, LLC believes the information contained herein to be accurate at the time of preparation and publication. The information has been compiled using sources believed to be reliable and accurate. Neither BuildBlock Building Systems, LLC, nor its employees or representatives make any representation or warranty, either expressed or implied, whether arising by statute, operation of law, custom of trade or otherwise, with respect to the accuracy or completeness of the information contained in this document or its fitness for any particular purpose, nor do they assume liability for damages or injury resulting from the application of such information.

BuildBlock Building Systems, LLC assumes no responsibility regarding the use of its products or any other third party products referred to in this document. It is the full responsibility of the user to comply with all applicable regulations and building code requirements concerning the use of these products and any other products outlined in this product manual. It is further the responsibility of the user to research and understand safe methods of use and handling of these products. To properly comply with the building codes in your area, contact your local distributor, dealer, or building code inspector.

PRODUCT WARNINGS

Many new types of treated wood products using ACQ (alkaline copper quaternary) are highly corrosive to metal components. BuildBlock Building Systems, LLC recommends that any metal products or components should not be used in contact with these treated lumber products unless you ensure the compatibility of your treated lumber with the metal components. Please consult with your project engineer to specify the type and sizing of all corrosion resistant metal connectors, anchor bolts, fasteners or other metal components. Please note that metal connectors, anchor bolts, fasteners or other metal components will corrode

and lose their load carrying capacity, if installed in corrosive environments.

TRADEMARKS

BuildBlock or BB BuildBlock and BuildDeck and any other drawings, symbols or marks identifying products and/or services of BuildBlock Building Systems, LLC are registered trademarks of BuildBlock Building Systems, LLC. All other trademarks, drawings, symbols or marks are the property of their respective owners.

INTRODUCTION

The BuildDeck Roof & Floor Decking System was designed to provide a cost effective, safe and easy to use deck system for the purpose of creating intermediate floors as well as pitched and flat roofs. Further plans include design, testing and engineering guidelines for the use of the BuildDeck system as a cost effective alternative to traditional tilt-up wall systems.

This system cuts costs by implementing light weight structural steel C channels as opposed to the large structural steel studs common in other systems. We have accomplished this by using high quality EPS foam molded at higher densities than competing systems. In testing, one panel was loaded to over 1000 lbs. without failure. Additionally the steel C channels provide a positive connection between the concrete and the ceiling element increasing the safety of the tenants in the structure.

The BuildDeck panels are designed to be molded in the same facilities as BuildBlock ICFs. This allows product to be shipped on the same truck to further drive down construction and shipping costs. They are packaged in bundles similar in size to our other products to simplify storage and handling.

We have worked very hard to provide a system that adds value to your project and your business. BuildBlock will always strive to develop this and other systems to provide the most benefit for our clients and their customers. We welcome your comments and look forward to better understand how the BuildDeck system promotes the growth of your business.

WARRANTY

BuildBlock warrants our products to be free of manufacturing defects. In the event that a defect occurs, BuildBlock will remedy the occurrence as per the guidelines of the BuildBlock Warranty Policy available on our website at buildblock.com.

SECTION 1: PRODUCT FEATURES

1.1 BUILDDECK PRODUCT DESIGN

Available in 8", 10" and 12" pre-molded heights with engineering for top hats up to 8" for longer spans.

Dovetail channels to provide additional concrete adhesion.

Large connection interlocks with self-draining vents

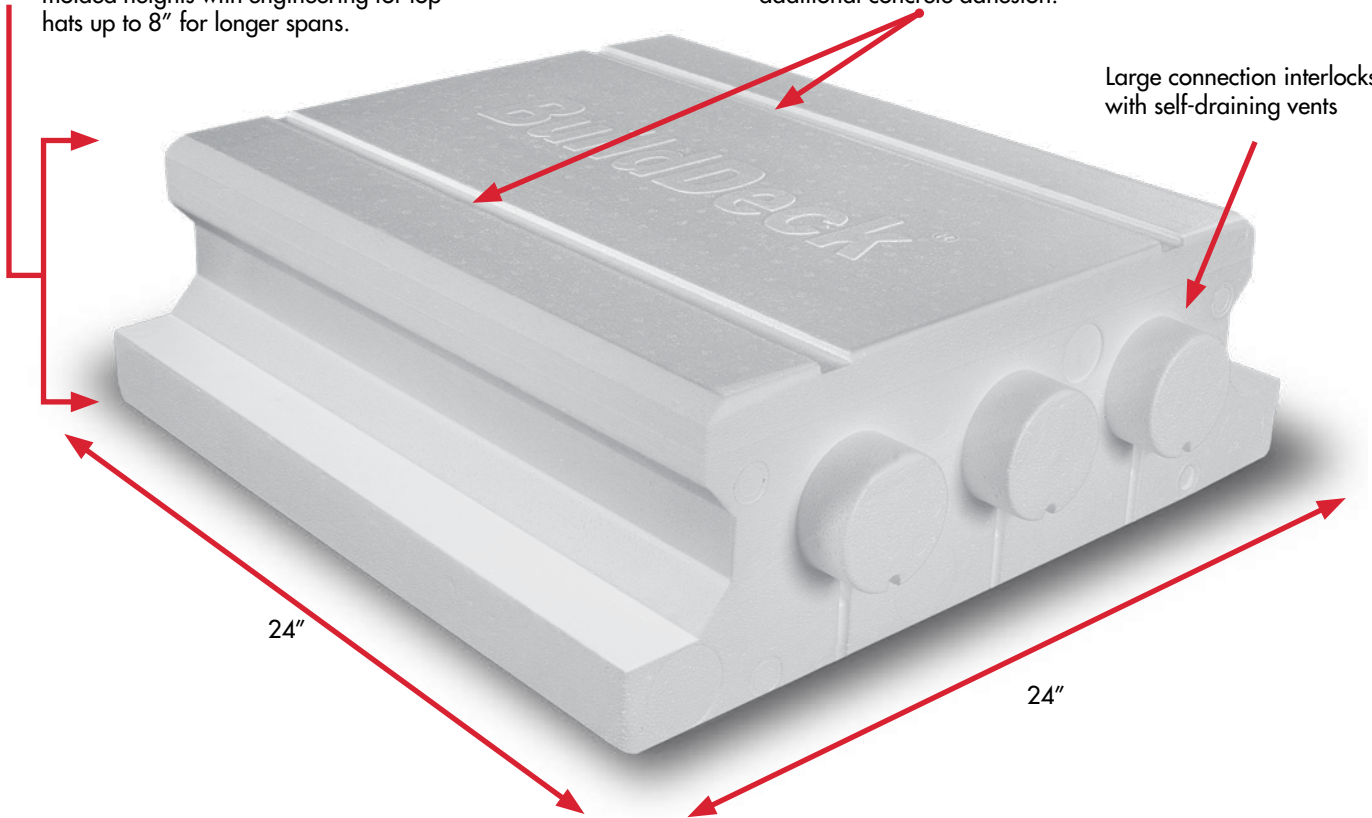

Molded-in numbered cut lines for fast fitting and easy installation on the underside of the form.

Self-draining Vents

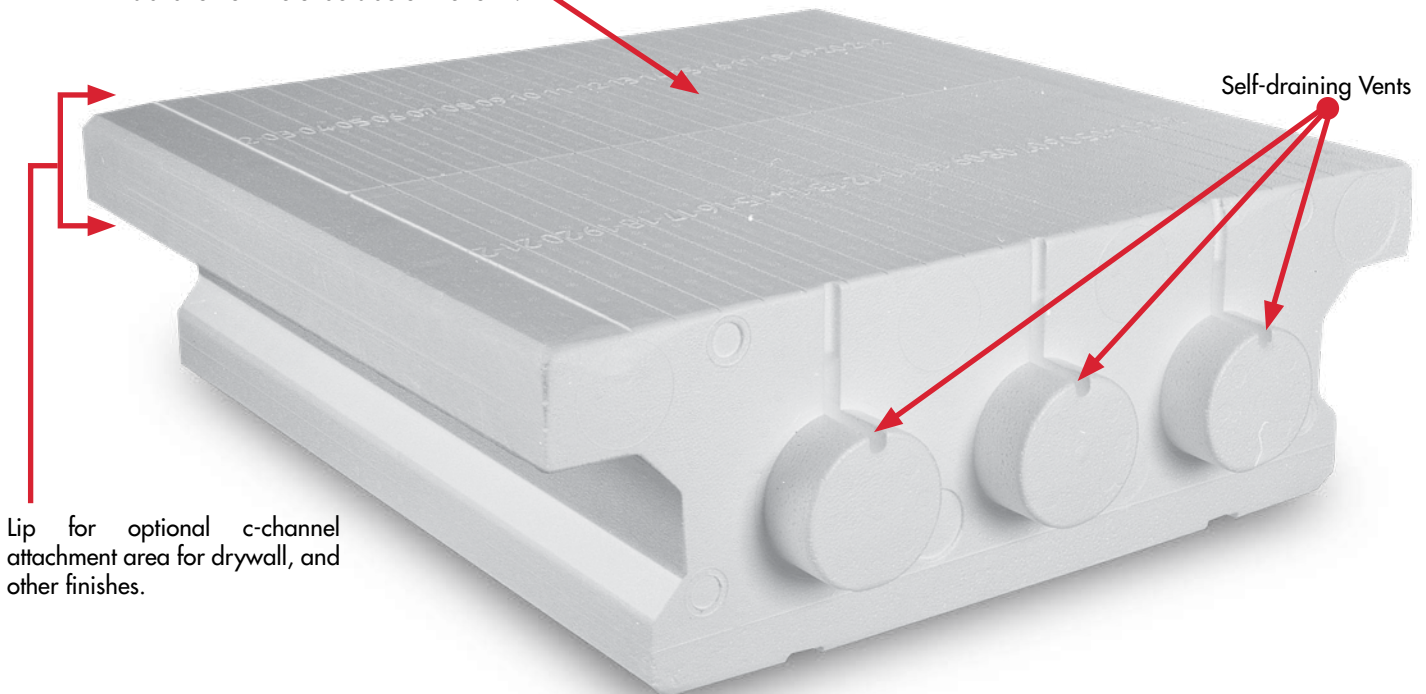

Lip for optional c-channel attachment area for drywall, and other finishes.

1.2 PRODUCT SPECIFICATIONS OVERVIEW

BuildDeck Roof & Floor Decking panels are 24" x 24", modular panels that are connected together and placed aside one another to create a stay in place form for deck beams and concrete caps (slabs). The forms stay in place to provide interior attachment points, insulation and noise mitigation.

SECTION 2: RECOMMENDED TOOLS AND ACCESSORIES

BuildBlock Building System carries a full line of ICF construction accessories that complement BuildBlock ICFs and related products when building residential homes, commercial, and industrial, buildings. Ensuring you have the tools to make installation quick and efficient will decrease frustration and save you money and time, increasing your bottom line.

- Folding Pruning Saw
- Skill saw
- Keyhole saw
- Table saw (optional, for convenience)
- Hammer drill, cordless drill
- Rebar tie tool
- Hot Knife or Hot Knife Kit combo*
- Hammer
- Framing square
- Concrete trowel
- Level
- Tape measure
- Transit or laser level
- Mason's line and chalk line
- Rebar bender
- Rebar cutter
- Wall alignment (bracing) system*
- Scaffold planks
- Concrete pencil vibrator, 3/4" low impact 1" maximum
- Foam guns, foam, and foam cleaner*
- Work gloves
- Sun Screen
- Broom and floor scraper

See the full BuildBlock Installation and Technical Manual for more products and accessories. Visit buildblock.com for more information.

SECTION 3: ESTIMATING BUILDDECK

3.1 ESTIMATING BUILDDECK PANELS

BuildDeck panels are modular deck panels. Each panel, regardless of height will cover four square feet of floor space. The formula used to determine the number of panels required will be length times width, divided by four (Area [in ft.] / 4).

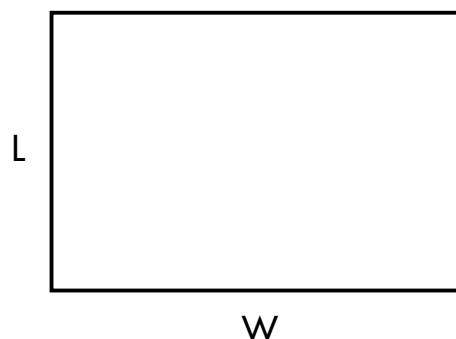

Figure 3.1.1 BuildDeck material estimating diagram using area of a rectangle divided by area of product.

EXAMPLE

$$L \times W / 4 = [\text{Total Number of Required Panels}]$$

Keep in mind that cut sections of a BuildDeck panel may be used. For instance, if your span is 20' - 6" long, you will need five full panels, and 1/4 (6 inches) of a sixth panel. For this reason you are able to cut one panel into four sections to complete your span, and lower the total number of panels required to complete the floor or roof.

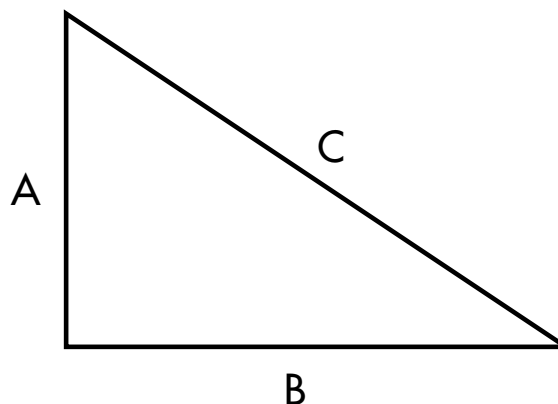

Figure 3.1.2 BuildDeck pitched roof material uses the rise of the roof as the length in the area calculation.

$$\text{Calculation: } A^2 + B^2 = C^2$$

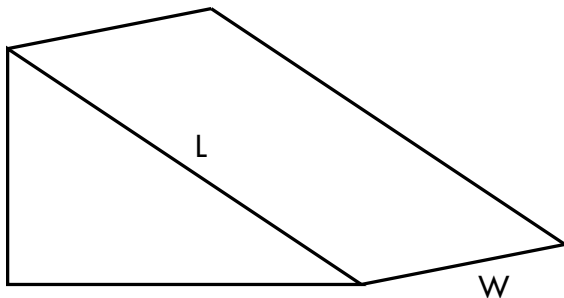

Figure 3.1.3 Using the rise of the roof as the length calculate the area of the roof, then divide by the area of the product to determine amount of material needed.

When calculating panels for a pitched roof, ensure that the number used for the length is representative of the hypotenuse of the triangle, not the base width of the structure.

This number should be used as the length then multiplied by the width of the roof section and then divided by the area of the product in square feet to determine the amount of product needed.

3.2 ESTIMATING CONCRETE

Use the following table to calculate the volume of concrete needed per BuildDeck panel used.

BuildBlock recommends 4000 psi concrete for use on decking systems, but this will ultimately be determined by the Engineer of Record and should not be assumed.

BUILDDECK CONCRETE ESTIMATION (PER PANEL)				
HEIGHT	LENGTH	WIDTH	AREA	CONCRETE (YD ³)
BD-800 (8")	24"	24"	4 ft ²	* .05111111
BD-1000 (10")	24"	24"	4 ft ²	* .05851852
BD-1200 (12")	24"	24"	4 ft ²	* .06037037
BD-1200+2 (14")	24"	24"	4 ft ²	
BD-1200+4 (16")	24"	24"	4 ft ²	
BD-1200+6 (18")	24"	24"	4 ft ²	
BD-1200+8 (20")	24"	24"	4 ft ²	

* Concrete volume is based on a top cap thickness of 3". Add .0122222 cu. yd. per form for each additional 1".

3.3 ESTIMATING REBAR

Each BuildDeck project will vary in terms of steel per the design specified by the Engineer of Record specific to the project. For this reason, calculations will be based on their recommendations.

As a general rule of thumb, each beam will have (2) runs of rebar in the bottom, and each concrete top cap or slab will contain a 12" x 12" grid of rebar, more than likely with #4 steel.

For estimation purposes:

5 feet of steel per BuildDeck panel used will provide an approximation of beam steel needed.

9 feet of steel per BuildDeck panel used will provide an

approximation of grid steel needed.

NOTE: The beam steel and grid steel will more than likely be different sizes so take this into consideration.

3.4 ESTIMATING BUILDDECK SHORING

Many methods of shoring may function to support the BuildDeck Flooring System during construction and curing. BuildBlock has commissioned the design of a cost effective, Engineer approved system that we recommend. Regardless of the system you choose, it is the responsibility of the user and/or contractor to ensure that all codes, laws and construction methods pertinent to your particular build are followed in regard to safety and structural integrity.

RECOMMENDED BUILDDECK SHORING DESIGN

The recommended BuildDeck shoring system is a wood framed shoring system comprised of stud walls spaced at 6ft o.c., with joists spanning underneath the BuildDeck panels at 2ft o.c.. The joists are to be centered along the joint between panels, perpendicular to the beam section of the form. The stud framed walls will be placed perpendicular to the joists, and parallel to the beams. The materials for shoring may be reused to frame interior walls in the rest of the project.

HIGH LOAD/ REUSABLE BUILDDECK SHORING DESIGN

An alternative BuildDeck shoring system consists of 2 x 8 girders supported every 72 inches by 4 x 4, 4 x 6 or metal posts running parallel to the concrete beams being formed, and 2 x 6 joists hung from these girders every 24 inches O.C. from Simpson or other code approved joist hangers to support the panels laterally.

This system has been reviewed and approved by a Professional Engineer as a medium duty shoring system. Most components can be re-used for future BuildDeck project installs.

2 x 8 Girders – Width of floor (Length [in feet] of wall perpendicular to beams) divided by six, multiplied by length of wall parallel to beams, multiplied by two. This will give you the number of linear feet of 2 x 8 board required. Divide this number by twelve to get the amount of 12' 2x8 boards needed.

Formula: $W/6 \times L \times 2$

2 x 6 Joists - Length of floor divided by two, multiplied by width of floor equals linear feet of 2 x 6 board required.

Formula: $L/2 \times W$

NOTE: We recommend that you build girders in 12' and 6' lengths as the supporting posts are designed to be placed every 6'. Additional lengths can be added to an end by splicing girders with longer spacers. Many systems are commercially available to extend post heights. Check the Ellis Manufacturing and other web sites for options.

3.5 ENGINEERING STATEMENTS

The following engineering statements from McLaren Engineering Group detail the installation of both BuildDeck shoring systems.



bridge, highway & rail engineering
entertainment engineering
subaqueous investigation
civil & site engineering
structural design
marine facilities
geotechnics
surveying

May 3, 2016

BuildBlock Building Systems, LLC
9701 N. Broadway Extension
Oklahoma City, OK 73114

Attn: Mr. Mark Kerfoot

Re: BuildBlock BuildDeck Shoring System for
BuildDeck BD-800, BD-1000, and BD-1200
McLaren File No. 150609.00

Dear Mr. Kerfoot:

At the request of BuildBlock Building Systems, LLC (BuildBlock), McLaren Engineering Group (McLaren) designed a wood framed shoring system for temporary support of BuildDeck Sizes BD-800, BD-1000, and BD-1200 with up to an 8" expanded polystyrene riser and up to a 4" thick concrete deck. All lumber used with the shoring system is to be Southern Yellow Pine No. 2 or better. The shoring system can accommodate ceiling heights up to 12'-0" and BuildDeck Spans between 12'-0" and 40'-0" consistent with the span capabilities of the three listed BuildDeck sizes. The system consists of framed walls with 2x4 or 2x6 studs at 16" o.c and 2x8 or 2x10 joists at 24" o.c on top of these walls. In-plane 2x4 wall bracing and out-plane 2x4 wall bracing provide lateral stability for the shoring system and shoring system attachment to the surrounding insulated concrete form walls is not required. See the attached Figure 1 for a view of the described shoring system and for member fasteners. Additional walls may be added and wall length may be increased to accommodate varying deck dimensions.

The wood framed shoring system is intended for temporary use during construction for a period of six weeks or less to support the indicated BuildDeck systems during installation and concrete curing. Review of the concrete slab or substrate supporting the shoring system was outside of the scope of this analysis and is by others. The following construction loads were used in the structural design of the shoring system:

Maximum Dead Load of BuildDeck and Concrete:	97 psf
Construction Live Load:	25 psf
Construction Wind Load (Per ASCE 37-02):	0.75 x 90 mph = 67.5 mph (ASD)

Construction live load is to be light duty loading i.e. during concrete placement on the BuildDeck, the deck should be sparsely populated with personnel, hand-operated

Offices: New York, Maryland, Florida, Connecticut, California

Licensed in:

Alabama • Arizona • Arkansas • California • Colorado • Connecticut • Delaware • District of Columbia • Florida • Georgia • Hawaii • Idaho • Illinois
Indiana • Kansas • Kentucky • Louisiana • Maine • Maryland • Massachusetts • Michigan • Minnesota • Mississippi • Missouri • Nebraska • Nevada
New Hampshire • New Jersey • New Mexico • New York • North Carolina • Ohio • Oklahoma • Oregon • Pennsylvania • Rhode Island
South Carolina • Tennessee • Texas • Trinidad & Tobago • Utah • USVI • Vermont • Virginia • Washington • West Virginia • Wisconsin • Wyoming

McLaren Technical Services, Inc.

5728 Major Blvd, Suite 603

Orlando, FL 32819

Phone (407) 354-5411

Fax (407) 354-3466

e-mail: fl@mgmclaren.com

On the web: www.mgmclaren.com

BuildBlock BuildDeck Shoring System
McLaren File No. 150609.00

Page 2
May 3, 2016

equipment, and staging of materials for lightweight construction. When building the shoring system, duplex nails of the size indicated in Figure 1 may be used for ease of shoring disassembly. At the contractor's option, wood screws may be substituted for nails as follows:

Nail Size Shown in Figure 1

10d Common Nail
16d Common Nail

Wood Screw Substitute

#12 Wood Screw x 3" Long
#14 Wood Screw x 3½" Long

No additional gravity loads in excess of the total 122 psf dead load plus live load are allowed on the wood framed shoring system prior to the concrete curing. It is recommended to leave the BuildDeck shoring system in place for the full 28 day cure time of the concrete unless early high strength concrete has been specified or other analysis has proven the BuildDeck system will not be damaged or compromised by removing the shoring early. **If constructed as detailed in the attached Figure 1, the BuildDeck Shoring System will be adequate for temporary support of BuildDeck Sizes BD-800, BD-1000, and BD-1200 with up to an 8" expanded polystyrene riser and up to a 4" thick concrete deck.** The seal show below is for responsibility for the temporary wood framed shoring system described in this letter and detailed in the attached Figure 1, and is not for responsibility of the final constructed structure, including the BuildDeck system supported by the shoring.

Feel free to call our office with any questions.

Regards,

The Office of
McLaren Engineering Group d/b/a
McLaren Technical Services, Inc.

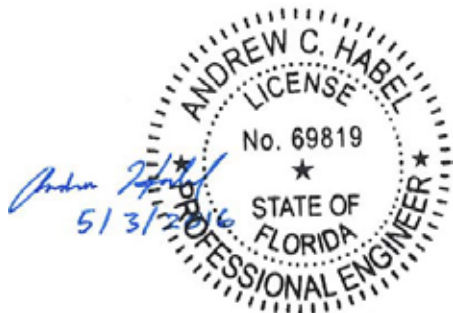

Andrew Habel, P.E. #69819
Florida Division Manager

cc: ACH, Internal File 160003.00

Attachments: Figure 1: BuildBlock BuildDeck Shoring System for BuildDeck BD-800, BD-1000, and BD-1200 with up to an 8" expanded polystyrene riser and up to a 4" thick concrete deck.



MCLAREN TECHNICAL SERVICES, INC.

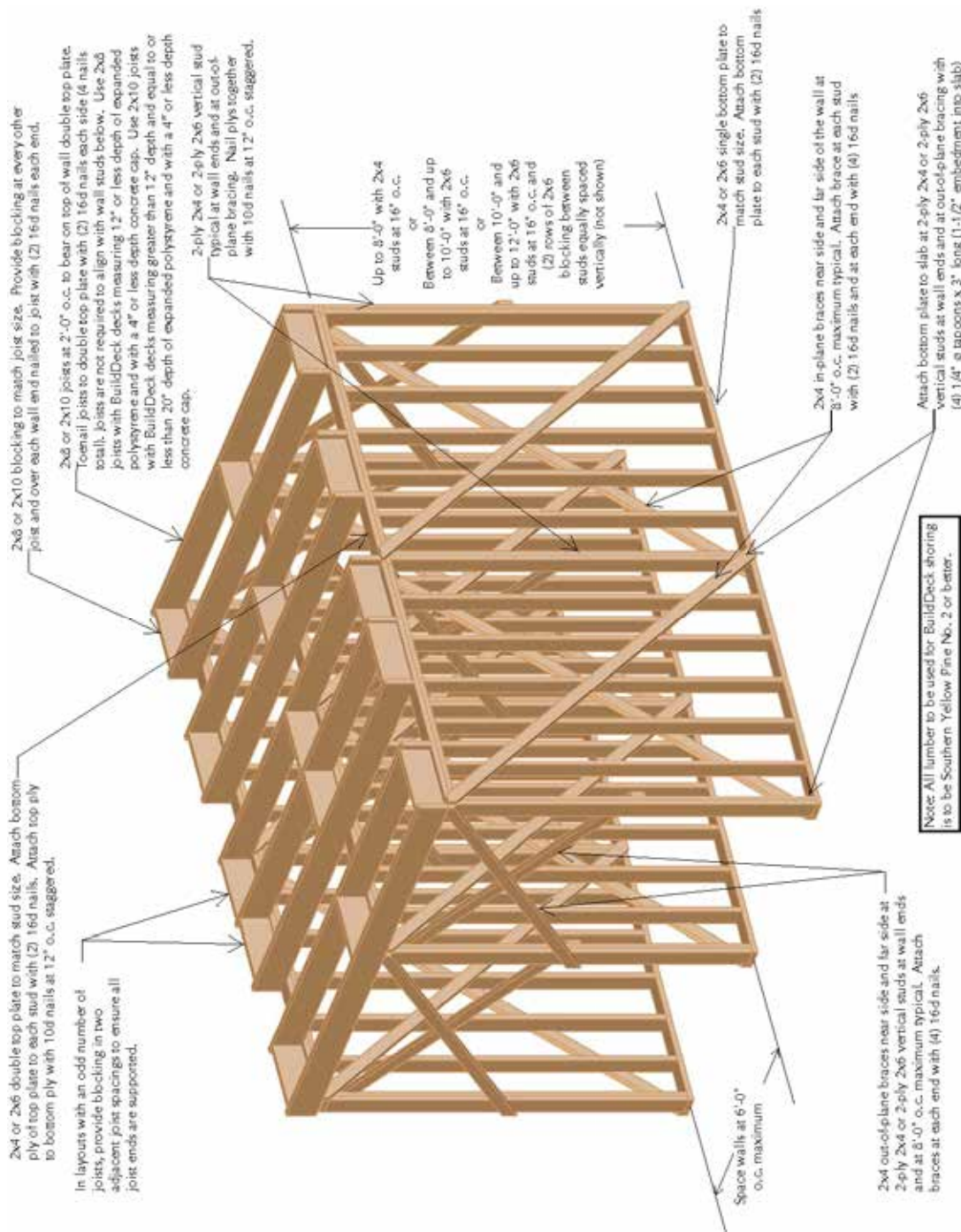

Figure 1: BuildBlock BuildDeck Shoring System for BuildDeck BD-800, BD-1000, and BD-1200 with up to an 8" expanded polystyrene riser and up to a 4" thick concrete deck.



MCLAREN TECHNICAL SERVICES, INC.

Figure 3.1.4 Recommended BuildDeck shoring materials.



bridge, highway & rail engineering
entertainment engineering
subaqueous investigation
civil & site engineering
structural design
marine facilities
geotechnics
surveying
forensics

September 22, 2009

BuildBlock Building Systems, LLC
9701 N. Broadway Extension
Oklahoma City, OK 73114

Attn: Mr. Justin Wallace

Re: BuildBlock BuildDeck Shoring System
MEG File: 109735.00

Dear Mr. Wallace:

This letter is presented as McLaren Engineering Group's analysis of the proposed shoring system of the BuildDeck floor system. The BuildDeck floor system consists of 2' x 2' EPS panels with concrete poured on top and in between two adjacent panels, forming a web and a flange. The layout of the shoring system was proposed by BuildBlock and consists of the following: wooden 2x or 4x posts spaced at 6' on center in both directions that support 2x girders that support 2x joists spaced at 2' on center. Some girders may be double-ply. Blocking in between these plies may range from 1/2" thick plywood to 1-1/2" thick 2x material; whatever is needed to allow for the connection to the post. McLaren understands that there are three sizes of BuildDeck EPS panels that may be used; the panel that requires the most volume of concrete has been used for design.

The following are descriptions of the different abbreviations used in this letter.

SYP – Southern Yellow Pine

DFL (N) – Douglas Fir-Larch (North) or Douglas Fir-Larch

L.L. – Live Load

Table 1 summarizes the allowable live load for the four various shoring framing systems.

JOIST TYPE	GIRDER TYPE	INTERIOR POST	EXTERIOR POST	ALLOWABLE L.L.
2X6 SYP #2	2X8 SYP #2	4X4 SYP STANDARD ^{2 3}	2X6X10' SYP #2 ¹	50 psf
2X6 DFL (N) #2 ⁴	2X8 DFL (N) #2 ⁴	4X4 DFL (N) #2 ^{2 3 4}	2X6X10' DFL (N) #2 ⁴	32 psf ⁴
2X8 SYP #2	2X10 SYP #2	4X4 SYP STANDARD ^{2 3}	4X4 SYP STANDARD ^{2 3}	90 psf
2X8 DFL (N) #2	2X10 DFL (N) #2	4X4 DFL (N) #2 ^{2 3}	4X4 DFL (N) #2 ^{2 3}	79 psf

Table 1 - Allowable Loads

Table 1 Notes:

a Note that post height doesn't include height of any jacking system employed.

1 2x6x10' post must be braced in the weak axis at mid-height. An acceptable bracing practice would be to screw the post to the ICF wall at 12" on center. If post height is 8' or less, acceptable post is as shown or 2x8x8' unbraced.

2 4X6 post may be substituted for 4x4 post.

3 Construction, standard, and #2 grades are interchangeable if same species is used.

4 This system that employs 2x6 DFL (N) #2 joists may only be used where construction type is explicitly light duty.

Offices: New York, Maryland, Florida, Connecticut, California

Licensed in:

Arizona • Arkansas • California • Colorado • Connecticut • Delaware • District of Columbia • Florida • Georgia • Idaho • Illinois
Indiana • Kansas • Kentucky • Louisiana • Maryland • Massachusetts • Michigan • Minnesota • Mississippi • Missouri • Nebraska
Nevada • New Hampshire • New Jersey • New York • North Carolina • Ohio • Oklahoma • Oregon • Pennsylvania • Rhode
Island • South Carolina • Tennessee • Texas • Trinidad & Tobago • Utah • Vermont • Virginia • Washington • West Virginia •
Wisconsin

M. G. McLAREN, P.C.

5728 Major Blvd, Suite 603

Orlando, FL 32819

Phone (407) 354-5411

Fax (407) 354-3466

e-mail:

florida@mgmclaren.com

On the web: www.mgmclaren.com

Table 2 summarizes the required Simpson (or other) connectors to be used.

MEMBERS	REQUIRED LOAD	CONNECTOR	AVAILABLE LOAD
2X6 JOIST TO 2X8 GIRDER	684 lb	LUS26 W/ (4) 10d NAILS	830 lb
2X8 JOIST TO 2X10 GIRDER	930 lb	LUS28 W/ (6) 10d NAILS	1055 lb
BEAM TO 4X COLUMN	STABILITY	(2) LPC4Z' OR ELLIS CAP	STABILITY
BEAM TO 2X6 COLUMN	STABILITY	LPC6Z'	STABILITY
GIRDER TO 2X4 BLOCKS	STABILITY	(4) 16d NAILS	STABILITY

Table 2 - Required Connectors

Table 2 Notes:

a Values have been taken from the 2009-2010 Simpson Wood Construction Connectors catalog.

1 Use (8) 10d nails into the beam and (8) 10d nails into the post.

The following are recommendations that must be followed to ensure that the shoring system functions properly:

- 1) **The shoring system must be somehow braced laterally in the direction parallel to the joist span. The system is considered braced if exterior posts are screwed to an ICF wall.**
- 2) All instructions and precautions for Simpson connectors and Ellis screw jacks and post caps must be followed.
- 3) All joists must be snug fit against the joist hanger on all four sides of contact.

Included below are pages 11, 19 and 20 from SEI/ASCE37-02 which is a standard for the design loads on structures during construction. Page 11 includes definitions and the table on page 19 classifies construction into four different types: very light duty, light duty, medium duty, and heavy duty. Each type has an associated uniform load which does not include dead load, construction dead load, or fixed material loads, so this uniform load can be considered a live load in the BuildDeck application. There are descriptions of these four types of construction to the right of the table and onto page 20. Two characteristics of heavy duty construction are concrete transport and placement using motorized buggies and material storage.

Note that in no case should heavy duty construction take place on the proposed shoring system; however it is acceptable to store limited quantities of 20 gage sheet metal and EPS panels over the girders. Any storage over the joists should be kept very minimal at all times.

It is the opinion of McLaren that the main construction type for the BuildDeck application is medium duty and therefore most systems require the use of a live load of 50 psf. Therefore, the shoring framing system employing 2x6 DFL (N) #2 joists should not be used unless construction type is explicitly light duty, which may be the case in some shoring applications.



M. G. MCLAREN, P.C.

SEI/ASCE 37-02

STANDARD

4.0 CONSTRUCTION LOADS

4.1 General Requirements

The provisions of this section shall be used to define the construction loads for the design of both temporary structures and permanent structures subject to loads during construction. These loads are to be combined with other applicable loads per the requirements of Section 2.

When a construction loading is covered in another document that is acceptable to the authority having jurisdiction and written to address a specific material or method of construction, the more applicable document shall be permitted to be followed.

Stairs, ladders, and elevators are not addressed in this standard.

4.1.1 Definitions

Construction loads: those loads imposed on a partially completed or temporary structure during and as a result of the construction process. Construction loads include, but are not limited to, materials, personnel, and equipment imposed on the temporary or permanent structure during the construction process.

Construction dead load, C_D : the dead load of temporary structures that are in place at the stage of construction being considered. The dead load of the permanent structure, either partially complete or complete, is not included in C_D ; the dead load of the permanent structure is defined as *dead load, D*, in Section 3.1.

Individual personnel load: a concentrated load of 250 lb (1.1 kN) that includes the weight of one person plus equipment carried by the person or equipment that can be readily picked up by a single person without assistance.

Working surfaces: floors, decks, or platforms of temporary or partially completed structures which are or are expected to be subjected to construction loads during construction.

4.2. Material Loads

The material dead loads consist of two categories:

1. fixed material loads (FML)
2. variable material loads (VML)

The FML is the load from materials that is fixed in magnitude. The VML is the load from materials that varies in magnitude during the construction process. If the local magnitude of a material load varies during the

COMMENTARY

C4.0 CONSTRUCTION LOADS

C4.1 General Requirements

The loads for some temporary structures, such as those that retain lateral pressures of earth, are not defined in Section 4; refer to Section 5 for lateral pressures of earth.

Standards and other documents applicable to specific materials or methods of construction have been developed and are recognized and used extensively.

C4.2. Material Loads

This section separates material dead loads into two categories: FML and VML, which are separated to permit the use of an appropriate load factor for each category in strength design. This approach recognizes the difference in the variability of the load between the two categories.

This section addresses the loads from materials and is not intended to apply to equipment loads. Per-

11

SEI/ASCE 37-02

SEI/ASCE 37-02

STANDARD

COMMENTARY

4.8 Application of Loads

C4.8 Application of Loads

Construction loads depend very much on the specific planning and processes of construction. This section includes rules for applying and combining the various loads, as well as traditional minimums for several common construction processes.

4.8.1 Combined Loads

The design construction load shall include the critical combination of personnel, equipment, and material loads.

C4.8.1 Combined Loads

The combination of the various forms of construction loads, materials, personnel, and equipment is an important step in engineering for construction, requiring careful application of professional judgment.

4.8.1.1 Working Surfaces. Structures supporting working surfaces as defined in Section 4.1 shall be designed for the combined material, personnel, equipment, and other applicable construction loads.

C4.8.1.1 Working Surfaces. It is traditional to design many working surfaces for a uniformly distributed load that is meant to include all construction loads, except for materials in their final position.

When the construction operation fits the definition in Table 2, the designer is permitted to design for the tabulated uniform loads as the vertical load from the combination of personnel, equipment, and material in transit or staging. When the construction operation does not fit the definitions in Table 2, the design shall be for the actual loads. Concentrated loads shall be considered separately.

Temporary structures have often been designed, advertised, and specified by the light, medium, and heavy duty ratings given in Table 2. This standard also applies to partially completed structures, and the same terminology is adopted. Different styles of construction and different segments of the construction industry have different traditions for design loads on partially completed structures during construction, and this section of the standard is an attempt to unify the industry on a common basis.

Table 2 Classes of Working Surfaces for Combined Uniformly Distributed Loads

Operational Class	Uniform Load* psf (kN/m ²)
Very light duty: sparsely populated with personnel; hand tools; very small amounts of construction materials	20 (0.96)
Light duty: sparsely populated with personnel; hand operated equipment; staging of materials for lightweight construction	25 (1.20)
Medium duty: concentrations of personnel; staging of materials for average construction	50 (2.40)
Heavy duty: material placement by motorized buggies; staging of materials for heavy construction	75 (3.59)

* Loads do not include dead load, D; construction dead load, C₁; or fixed material loads, C₁₆.

Examples of construction operations that have traditionally been designed for the loads given in the table are

- Very light duty:
 - Roofing, reroofing, excepting situations with stock-piles of ballast
 - Access catwalks
 - Painting, caulking
 - Maintenance using hand tools
- Light duty:
 - Light frame construction
 - Concrete transport and placement by hose and concrete finishing with hand tools
- Medium duty:
 - Concrete transport and placement by buckets, chutes, or handcarts
 - Concrete finishing using motorized screeds
 - Masonry construction with tile or hollow lightweight concrete units
 - Structural steel erection or concrete reinforcing steel placement



M. G. McLAREN, P.C.

DESIGN LOADS ON STRUCTURES DURING CONSTRUCTION

STANDARD

4.8.1.2 Specification of Temporary Structures. When temporary structures are specified by load name, the names of the load class and the magnitude of design loads shall be as given in Table 2.

4.8.2 Partial Loading

The full intensity of the construction load applied only to a portion of the length of a structure or member shall be considered if it produces a more unfavorable effect than the same intensity applied over the full length of the structure or member.

4.8.3 Reduction in Construction Loads

4.8.3.1 Material Loads. No reduction is allowed for fixed or variable material loads, except to the extent that small amounts of material in transit or staging are included in uniformly distributed personnel, equipment, and material loads, such as those in Table 2.

4.8.3.2 Personnel and Equipment Loads. When justified by an analysis of the construction operations, members having an influence area of 400 ft² (37.16 m²) or more may be designed for a reduced uniformly distributed personnel and equipment load determined by applying the following formula:

$$C_P = L_w (0.25 + 15/\sqrt{A_I}) \quad (4-6)$$

$$C_{P SI} = L_w (0.25 + 4.57/\sqrt{A_I}) \quad (4-6 SI)$$

20

COMMENTARY

Heavy duty:
Concrete transport and placement using motorized buggies
Masonry of brick or heavy-weight concrete units
Material storage

Conflicts between provisions of this section and those in ASCE 3-91 and ASCE 9-91 are acknowledged.

Following are examples of working surfaces that do not fall under Table 2:

Roofs for which design is controlled by building code live load or snow loads that are less than values in Table 2.

Attics or hung ceilings that provide access for maintenance, installation of utilities, and emergency services such as firefighters.

These working surfaces must be addressed in accordance with Sections 4.8.1.1 and 4.8.4.

C4.8.1.2 Specification of Temporary Structures. This requirement will encourage uniformity in terminology for capacity of scaffolds and similar structures.

C4.8.2 Partial Loading

Partial-length loads on a beam or truss may produce higher shear on a portion of the span than a full-length load. Checkerboard loadings on floors and multistory frames produce the highest positive and negative moments. Cantilevers cannot rely on a possible construction load on the anchor span for equilibrium. ASCE 7-95 describes other possible conditions of designing members or floors for partial loading.

C4.8.3.2 Personnel and Equipment Loads. Uniformly distributed loads are a convenient substitute for computing the combined effect of several concentrated loads. As such they are generally calibrated to a particular area. For smaller areas, the concentrated loads control structural design. The nature of transient concentrated loads, such as personnel and equipment, is that their spacing is not uniform, thus, for areas larger than the calibration area, the uniform load may be unnecessarily conservative.

BuildBlock BuildDeck Shoring
MEG File No. 109735.00

Page 6
August 25, 2009

If you have any questions and or comments please contact me at (407) 354-5411 or via email at roleck@mglmclaren.com.

Very truly yours
The Office of
McLaren Engineering Group
M.G. McLaren, P.C.

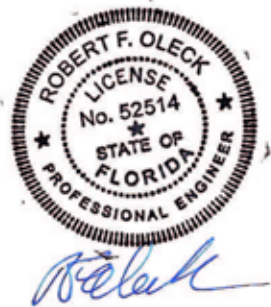

Robert F. Oleck, Ph.D., P.E.
Regional Director

cc: MGM, WRM, DWH,

P:\PROJ109\109735-BUILDBLOCK FLOORDECK SHORING\3. CORRESPONDENCE\LETTERS\SENT\LTR01-J.WALLACE-109735-092209.DOC



M. G. McLAREN, P.C.

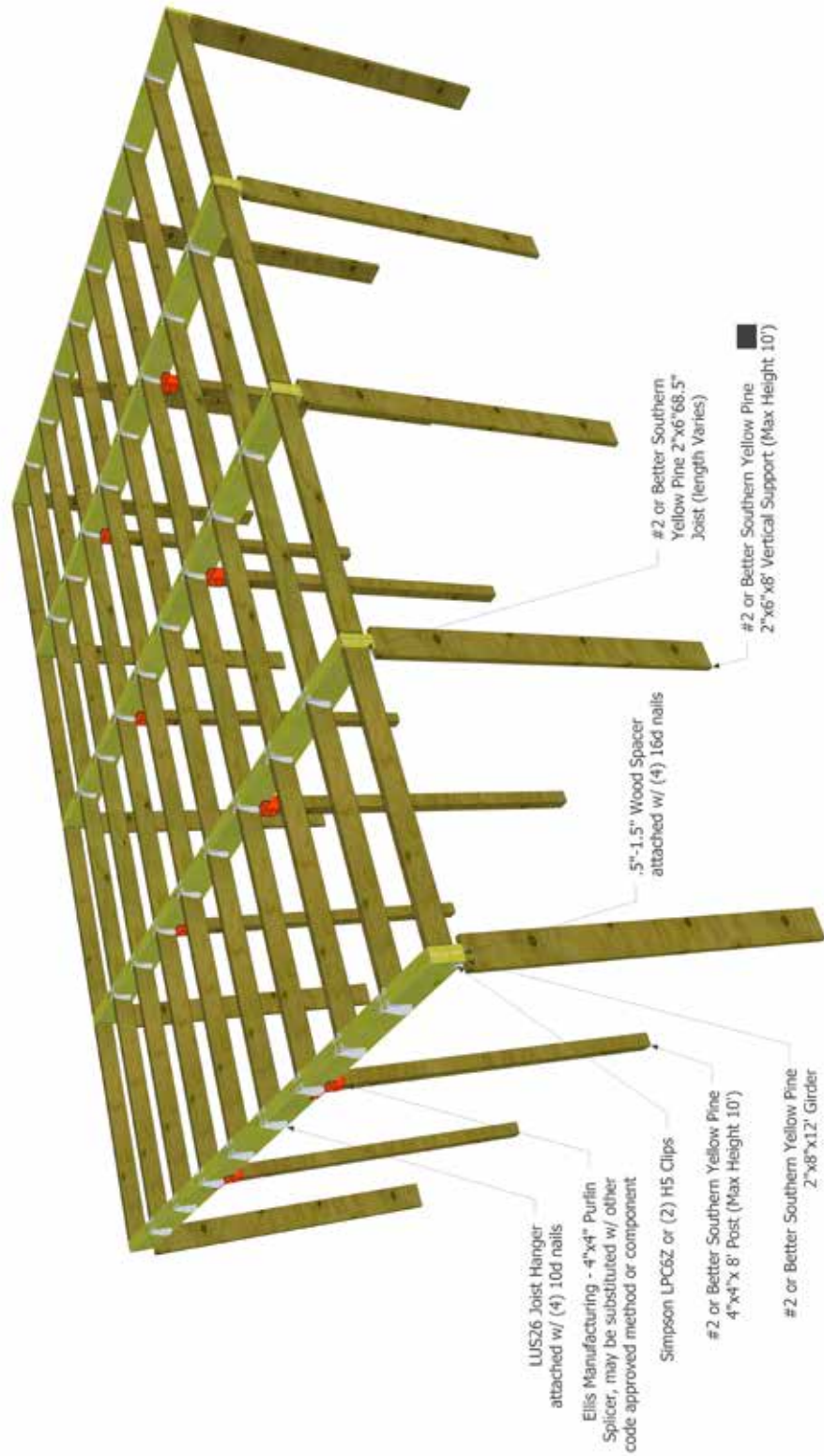

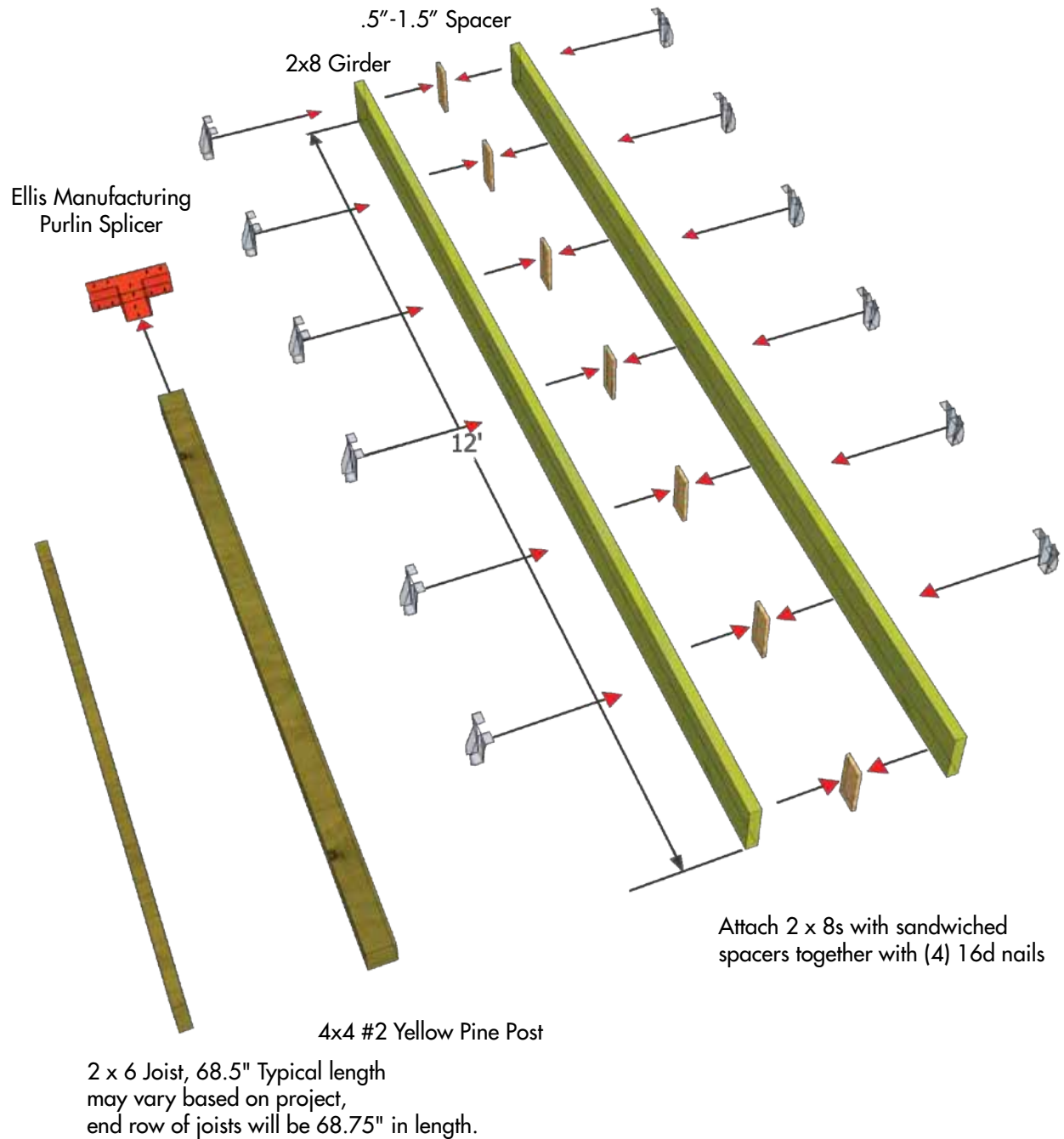
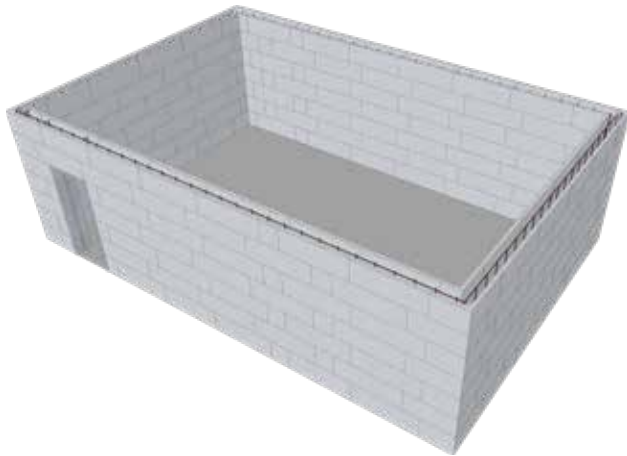

Figure 3.5.1 BuildDeck shoring girder assembly.

SECTION 4: BUILDDECK INSTALLATION



4.1 WALL INSTALLATION

Stack BuildBlock ICF Forms to the intended “top of floor height”. Decide if you will top mount or side mount the BuildDeck system to your ICF or other wall system. This will determine the height you will cut the interior panel of the wall.

Note that steel frequency may be increased in walls to support heavier loads as specified by the Engineer or construction plans/guidelines.

Provide appropriate steel end length stub out from wall if above story is to be constructed in ICF.

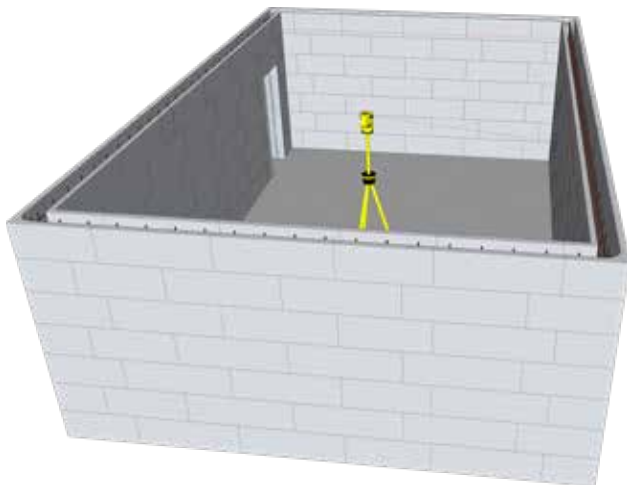

4.2 INTERIOR WALL PANEL HEIGHT

After determining the mounting method for your floor system, use a laser level or construction level to mark the intended “bottom of floor” height.

Bottom of Floor is determined by adding the depth of the deck system being used and the depth of the intended concrete cap. Subtract the sum from the overall height of the wall (top of floor height).

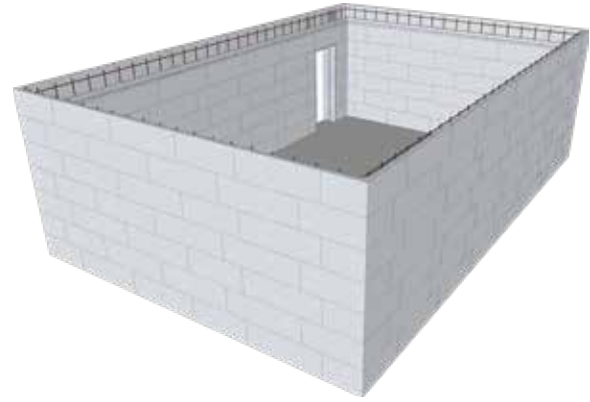

4.3 CUT INTERIOR PANEL

Once the ceiling or “bottom of floor” height is determined, cut the interior wall panel to the appropriate height.

The interior panel height may differ based on project design, needs or preferred installation practices. The goal is to make a smooth transition between the floor and wall systems.

When using the top mount method of installation, you will cut the interior panel flush at the “bottom of floor” level on all sides.

When using the side mount method, you will cut the interior ICF panels running parallel with the floor beam to 2.5” above “bottom of floor” height. (ref. sec. 4.4) The interior panels at the end of the floor beams can be cut to “bottom of floor” height + panel height, or “bottom of floor” height + 2.5”.

You may make a template of the beam cavity profile, measure where your beams will line up in the wall and cut the end of wall panels in advance to match the beam cavity profile or place floor panels and come back with an ICF saw to cut excess foam away from the beam cavity to match beam cavity profile.

For our example structure, we will use the side mount method. As you can see in the picture, the side wall and the end wall are cut to “bottom of floor” + 2.5”.

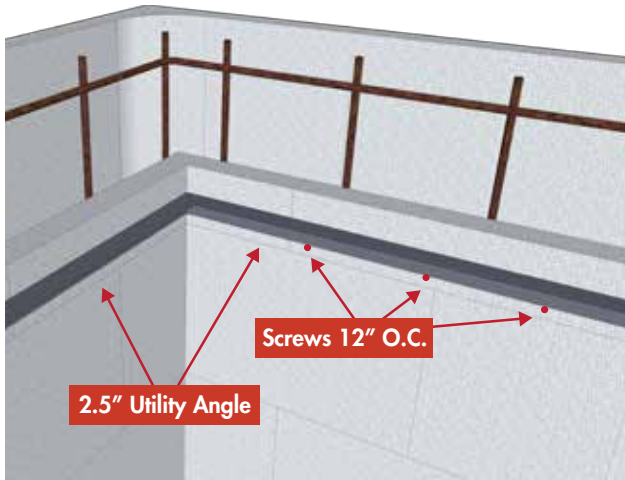

4.4 UTILITY ANGLE PLACEMENT

In order to provide a sheetrock attachment point (if necessary) around the perimeter of your intended ceiling (bottom of floor), install standard light gage 2"x2" utility angle at the marked "bottom of floor" height. Attach the utility angle to the BuildBlock webs 12" O.C. with #6 or #8 fine thread drywall screws (recommended), pan head screws as well as self tapping sheet metal screws are also acceptable.

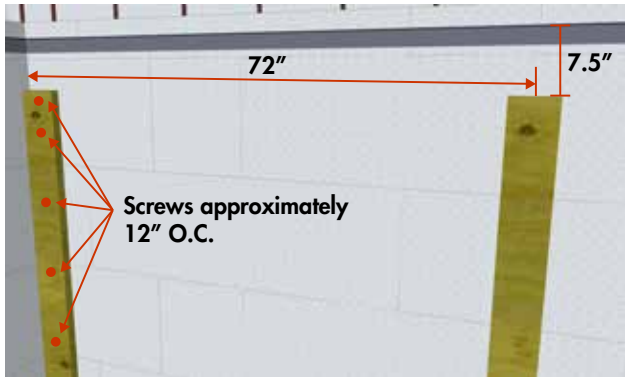

4.5 VERTICAL GIRDER SUPPORTS PLACEMENT

The girders that will make up the main support for your shoring system will sit on a series of posts spaced on a 72" x 72" grid. The first step to erecting the shoring system is to install the vertical supports along your ICF walls. The first vertical support will be attached in the corner. The second support will be placed 72" on center from the ICF side wall (parallel to concrete beams being formed), and 72" O.C. thereafter. Your vertical supports and posts will be "bottom of floor" height -7.5" (girder height).

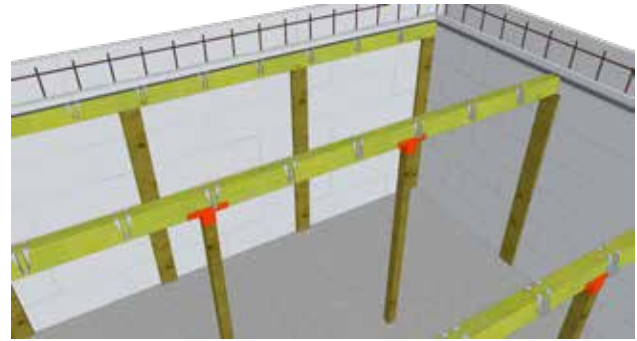

4.6 GIRDER PLACEMENT

Once vertical girder supports have been securely affixed to the ICF walls, install the first girder to the side wall.

Next, start to install the girders as the center posts are erected.

The girders should be connected to the posts by mechanical method such as the Ellis Manufacturing Co., purlin splicer.

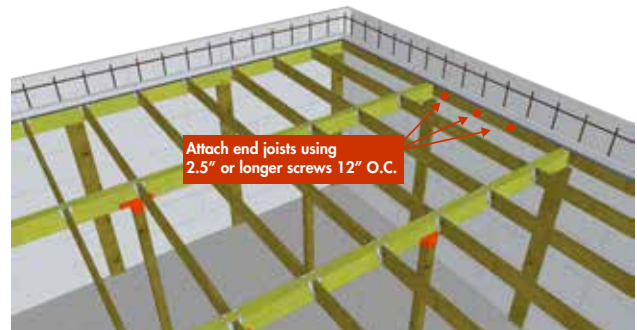

4.7 JOIST PLACEMENT

After girders with attached joist hangers are in place, drop the pre-cut joists into the available joist hangers. These do not need to be nailed in place, but care should be taken to ensure there is no gap more than 1/8" between joist ends and girders.

End joists are attached to the ICF webs with screws no shorter than 2.5", 12" O.C.

Place one screw high and one screw low at the ends of the joist, or stagger screws.

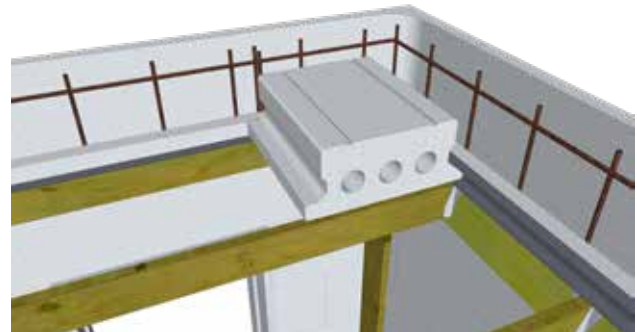

4.8 DECK PANEL PLACEMENT

Install Panels starting in one corner. If a cut panel is needed to fit a specific beam length, start with the male side facing out, and make the cut on the last panel, cutting excess from the female side. This will ensure that concrete does not flow into the hollow core.

The steel ceiling attachment strip can be placed on either side of the panel so long as every row has an attachment strip where required.

Panels will interlock male to female in a row. If using a ceiling attachment strip, it may be easier to place one row at a time.

For smaller applications such as a small safe room, it may be easier to assemble rows of panels with glue on the ground and move them up to the shoring as a unit as the panels are very light weight.

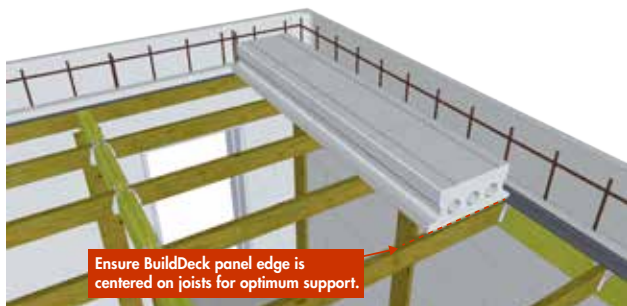

As you place panels, take special care to ensure that the BuildDeck seams line up centered on the joists for optimum support.

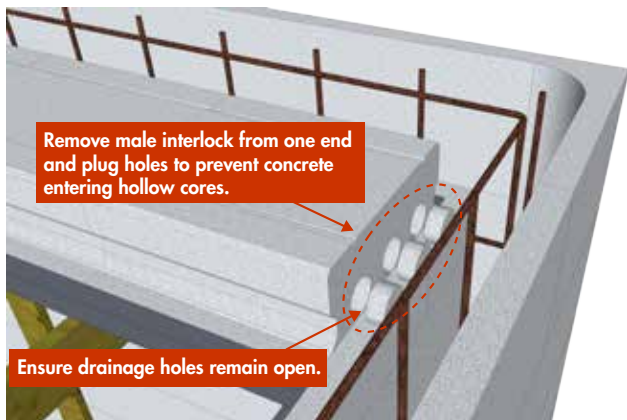

Depending on the mounting method chosen for the install, the male protrusions may be cut off the end panel and used to plug the opposite end to eliminate concrete waste caused by filling up hollow cores unintentionally.

If the panels are cut to the proper length there is no need to provide any attachment to the ICF walls. If the installer feels it is necessary, or if there are gaps or alignment issues, the panels may be attached to the ICF walls with foam to foam, low expansion glue. Make sure that drainage holes do not get filled.

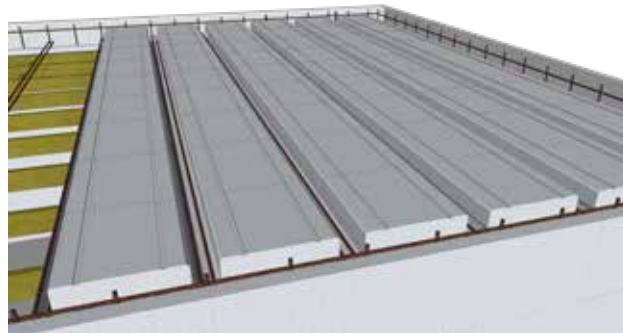

Continue completing rows and sandwiching the steel attachment strips between the panels to complete the floor or roof deck. One crew member can be placing the bottom steel rebar in the bottom of the beam panels as you complete a row to prepare for tying steel.



Once your BuildDeck panels are placed and the bottom steel is set in the bottom of the beams it is time to place your steel.

Concrete codes require a minimum concrete coverage of .75" embedment around your rebar. If the project calls for a 2" concrete top cap, make sure your engineer has taken this into consideration.

For these applications a re-wire mesh will be required which may lower the live load rating as well as the span length and up lift strength.

4.9 REINFORCEMENT PLACEMENT

WARNING

ALL STEEL DESIGN MUST BE SPECIFIED BY THE ENGINEER OF RECORD.

When working with the engineer, ensure that your grid steel is specified on an increment of 6", 12" or 24". This will ensure easy placement of bottom beam steel.

Start by placing steel that runs parallel to the concrete beams. This steel must span up to or past the vertical steel bars in the ICF wall. This steel can sit on a number of commercially available rebar chairs. Steel wire chairs work best as they can be pressed into the BuildDeck panels for stability.

The bottom beam steel may be set in rebar chairs or hung

from the concrete cap grid steel with stirrups depending on the span, application and specifications of the Engineer. All steel must be tied at each end point and each intersection with code approved fastening procedures or mechanisms.

All steel splices must have an overlap of a minimum 40 diameters of the rebar. Bent angle rebar is required to connect grid steel and vertical steel in walls with ANSI approved bends, appropriate minimum overlap and code approved fastening procedures. Bottom beam steel may require bent angle rebar as per Engineered specifications.



When parallel concrete cap grid steel and bottom beam steel are properly and securely placed start to place perpendicular concrete grid steel. This steel must be appropriately tied, terminated and spliced as well.

Place a straight edge across one corner and measure the distance from the bottom of the straight edge to the top of the highest level of grid steel. This measurement must be at least .75" to achieve minimum concrete embedment.

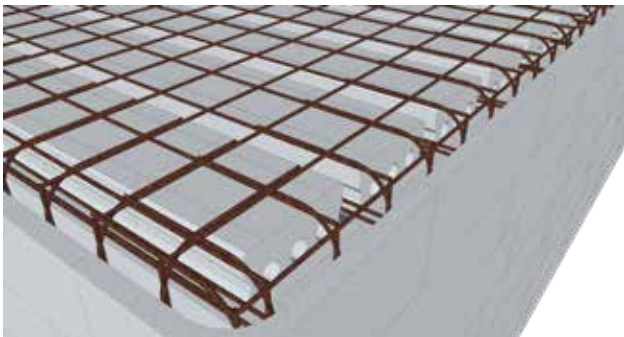

Place a 90 degree angle rebar at the end of each piece of concrete cap grid steel in each direction, tying in the concrete cap grid steel to the vertical wall steel.

This is for example purposes only. The Engineer of record must specify final design.

Where additional support for ceiling elements is desired, the installer may drive 3"-3.5" screws through the steel attachment strip from the underside of the system which will allow for better adhesion between the concrete and the attachment strips prior to pouring.

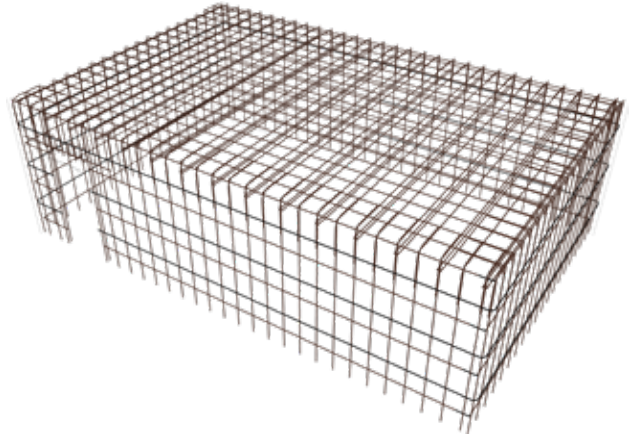

The end result will be an interconnected steel reinforcing grid that can be designed by FEMA guidelines to be considered "near absolute protection" from natural disasters when combined with the strength of the monolithic concrete shell.

Follow all applicable codes regarding steel placement, tying and splicing.

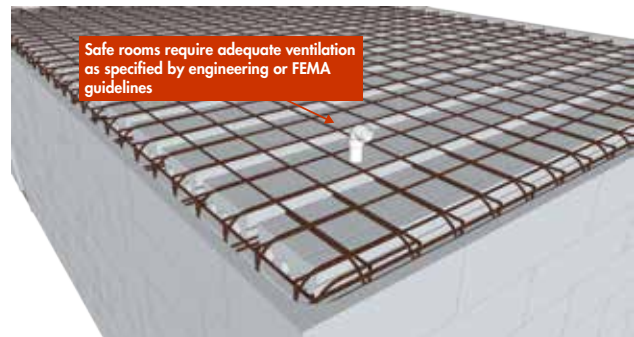

4.10 UTILITIES PLACEMENT

Certain applications may require the passage of drainage and plumbing pipes, electrical conduit, vent and HVAC plenums or various other utility items to pass through levels. Additionally, safe rooms will require fresh air vents that will connect safe room space to attic space.

Work with your Engineers, designers and contractors to ensure that you know the proper placement of these items prior to pouring. Cut a hole the appropriate size for the intended item and place the item or a sleeve or block out for the item into the decking system. Seal all edges with foam to foam, low expansion glue. Extra shoring may be required around penetration openings.



4.11 PRE-POUR CHECKLIST

Each installer should have a Pre-Pour checklist. This is a living document of sorts that may grow and change based on project needs and personal preferences. A few items that will always be vital to check prior to pouring are as follows:

- Check all ICF bracing for proper set up
- Inspect or install additional shoring where needed
- Go over utility diagrams one last time
- Inspect all deck shoring for stability
- Ensure that all ceiling attachment strips are in place
- Inspect all steel, steel splices and intersections for proper installation and concrete embedment
- Verify concrete mix ordered
- Place additional shoring in any areas of concern
- All finishing tools are present - floats, shovels, vibrators, hand tools, trowels, etc.
- All accessories are present - anchor bolts, extra lumber

4.12 CONCRETE PLACEMENT

Pour ICF walls per installation guidelines outlined in the BuildBlock Installation Manual.

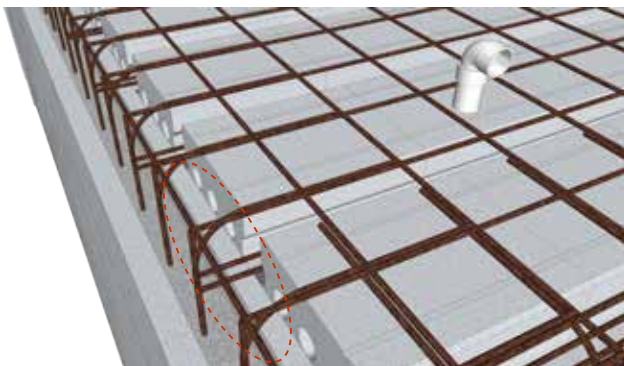

Take special care to keep edges clean and free of concrete where the concrete floor beams and the concrete wall meet. If concrete spills here and hardens, a cold joint can form at this

critical point.

Fill the walls to a level just below where they intersect with the floor system. Do not place a cold joint at the intersection of the floor and wall systems.

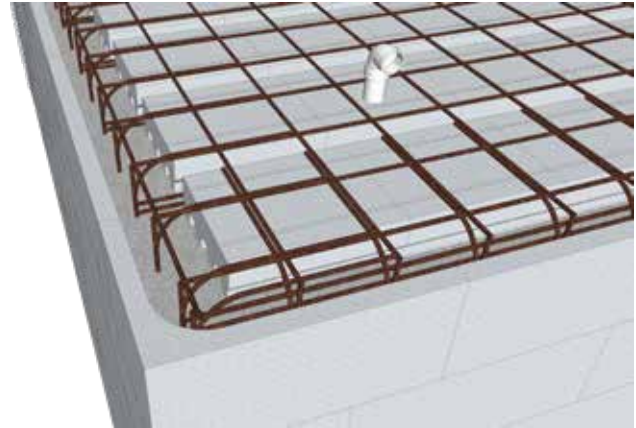

Once the wall cavity is filled the appropriate level, start to fill the concrete beams. Vibrate the concrete very thoroughly as it is being placed. Monitor rebar to make sure that the minimum .75" concrete embedment is achieved on all sides of the steel.

Do not allow entrance by any person to the underside of the floor while concrete is being poured. Use caution beneath floor while floor is curing.

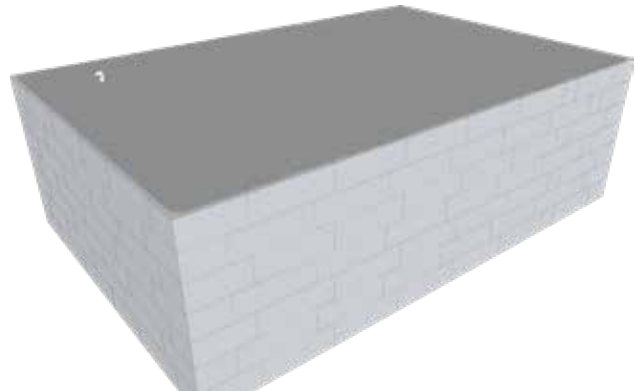

Continue to pour concrete, spreading and floating as you go. Fill to the top of floor height and finish using typical flatwork methods and procedures.

Place any anchor bolts in pre-marked locations as the floor is being finished, while concrete is still wet if applicable.

Do not use heavy equipment for finishing unless proper shoring precautions have been taken.

SECTION 5: BUILDDECK SHORING REMOVAL

5.1 SHORING REMOVAL OVERVIEW

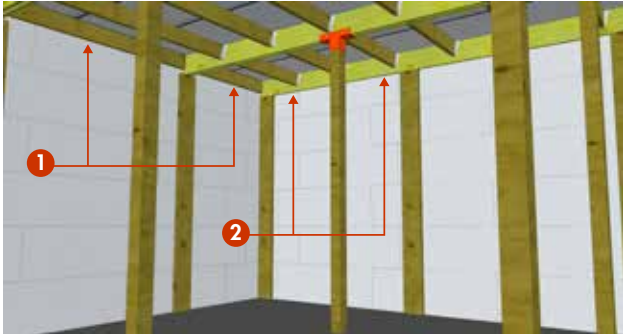

Overview

1. To remove shoring after the 28 day cure time has elapsed, start by removing screws from the joists that are attached to the walls between girders. Remove the joists and store for future projects.
2. Remove screws in end wall vertical supports and end wall girder on one end.
3. Carefully lower end wall vertical supports to a height that will allow removal of the first set of joists. Remove these joists and store for future projects.

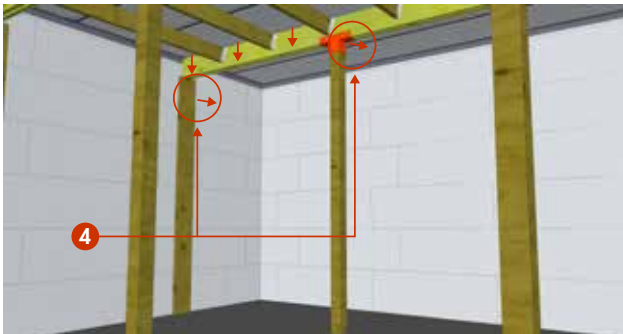

4. Slide the first girder back by approximately 1.5", but let it rest on the tops of the side wall vertical supports still. This adjustment should allow the installer to slide one end of the joists in the next row over and safely remove the joists.
5. Once all joists in the section are removed, lower the girder, detach posts and store for future projects. Repeat this step until you reach the other end wall.
6. Remove remaining vertical supports and store for future projects.

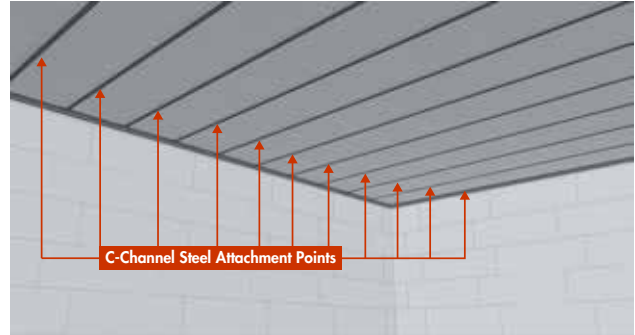

5.2 INTERIOR FINISH ATTACHMENT

The c-channel steel strips installed between each panel serve as attachment strips every 24" for sheet rock or other fire rated, code approved finish materials. If the finish application is a stucco or similar product that adheres directly to EPS, these attachment strips may not be required but are strongly recommended.



BUILDDECK ROOF & FLOOR DECKING SYSTEM DESIGN, ENGINEERING, AND INSTALLATION MANUAL



SECTION 6: BUILDDECK CAD DETAILS

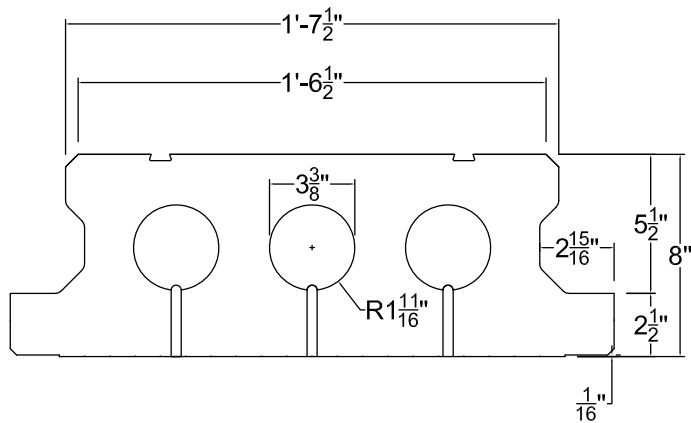

Note:
Due to variations in printers and print settings, this detail may or may not be to scale.

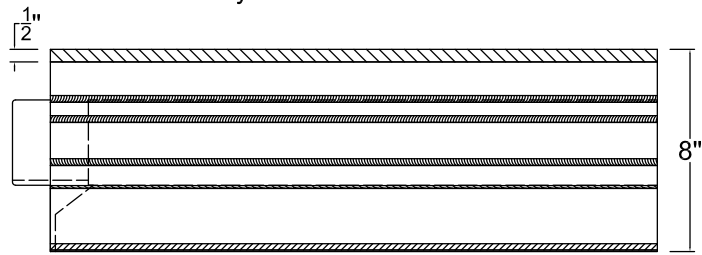

Note:
All concrete and steel design must be approved by the project specific Engineer of Record

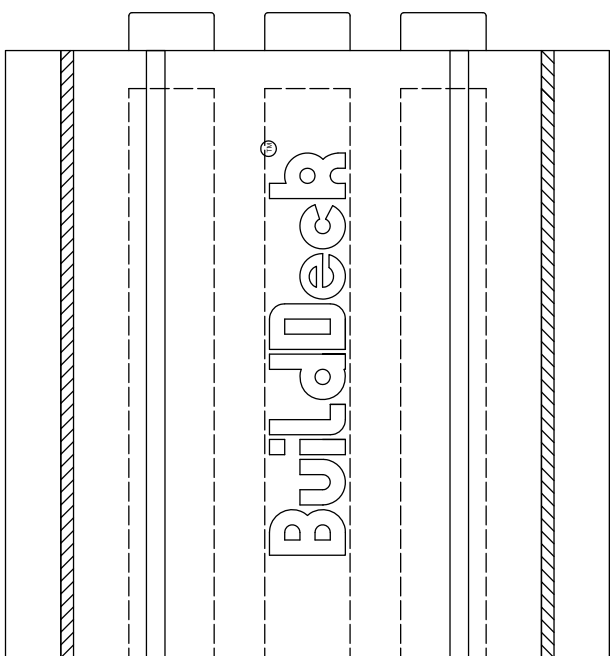
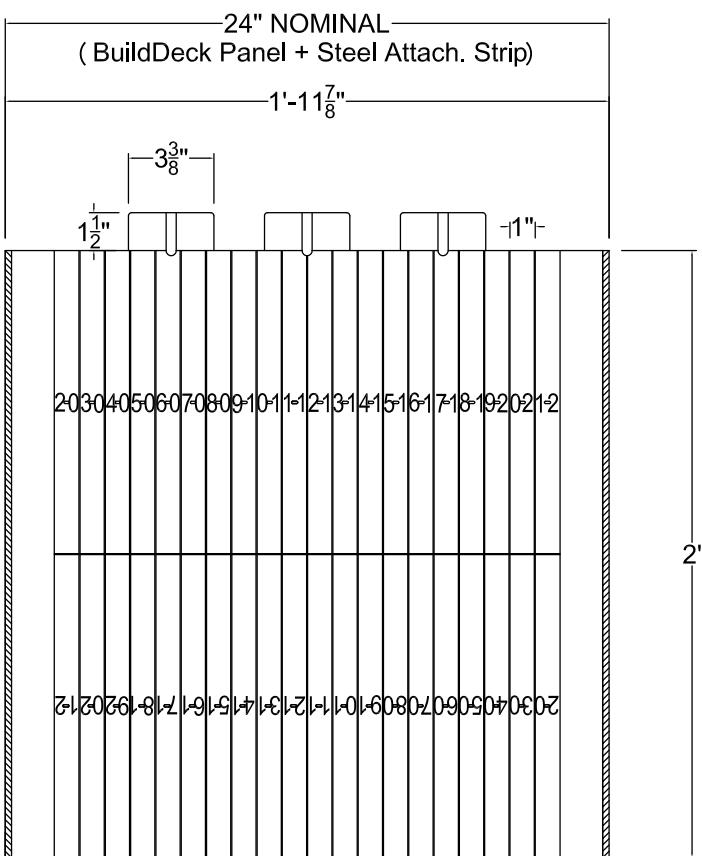
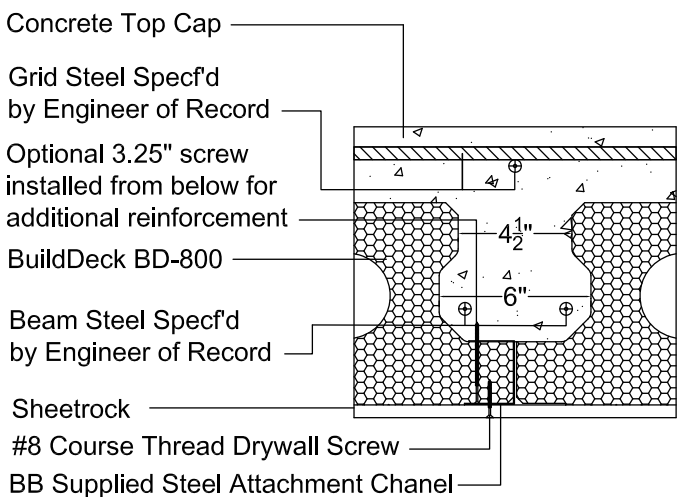

BB BuildBlock
BUILDING SYSTEMS

OFFICE: 405-840-3386 | TOLL FREE: 866-222-2575 | FAX: 831-597-0792
buildblock.com

BUILDDECK 8"			
DATE/REV	11-17-09	SCALE	NTS
NOTES	BD-12+2		DETAIL SHEET
CONSTRUCTION SHALL BE IN ACCORDANCE WITH ALL APPLICABLE LOCAL AND NATIONAL CODES. ALL DRAWINGS ARE SUBJECT TO CHANGE WITHOUT NOTICE.			5D

Note:
Due to variations in printers and print settings, this detail may or may not be to scale.

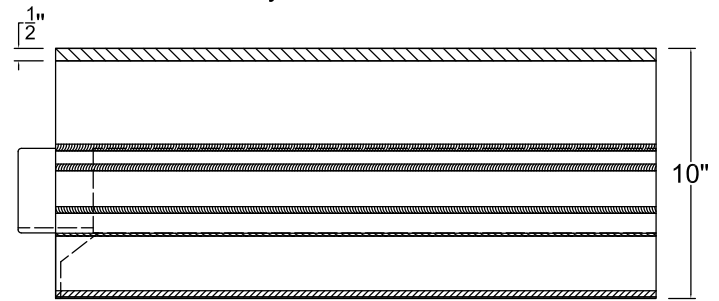
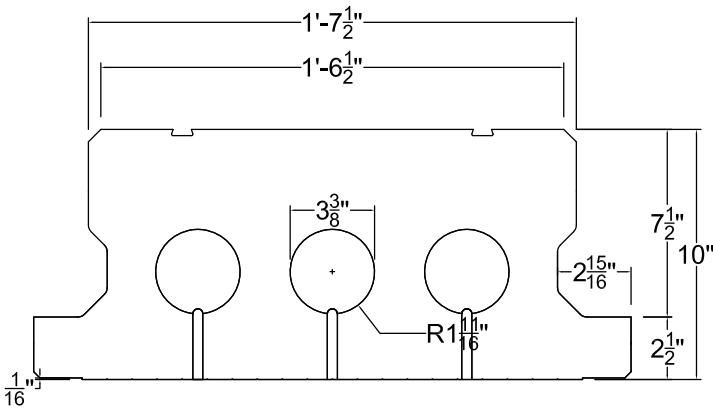

Note:
All concrete and steel design must be approved by the project specific Engineer of Record

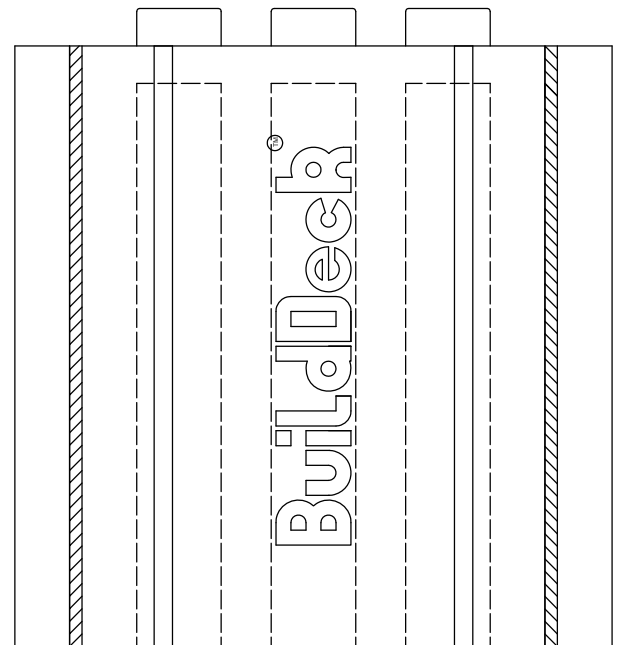
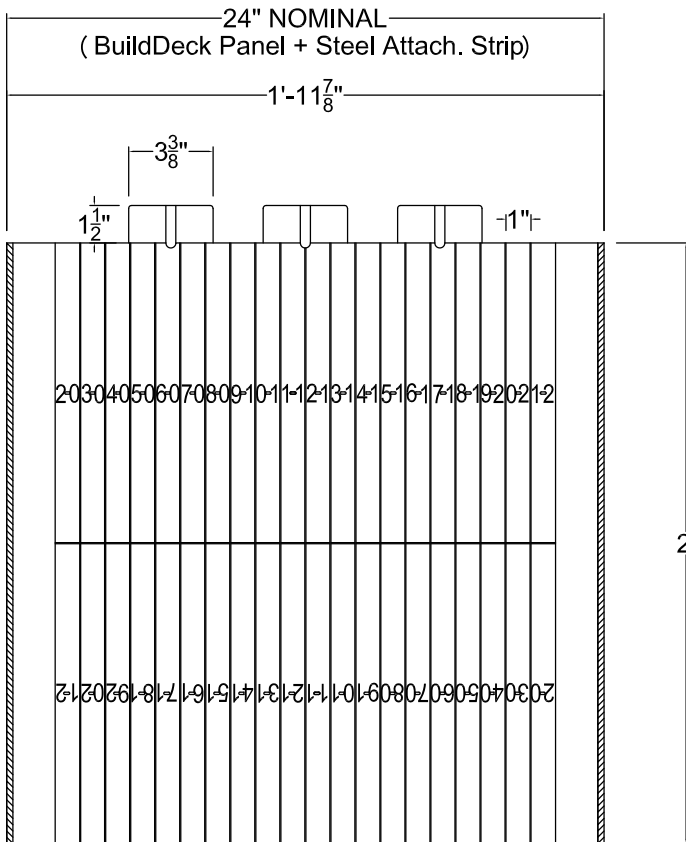
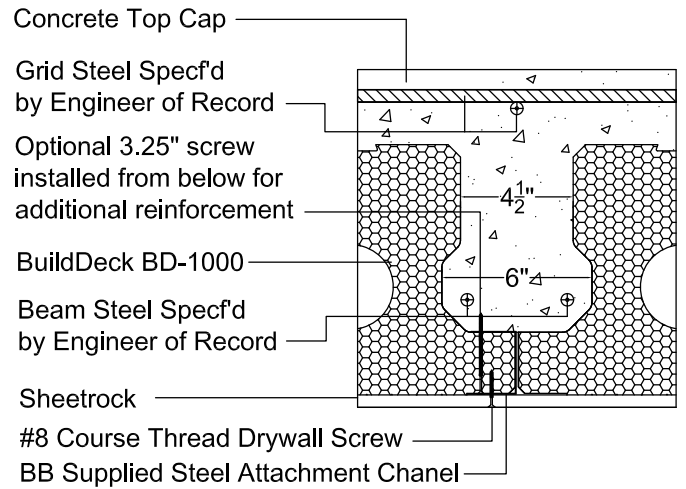

OFFICE: 405-840-3386 | TOLL FREE: 866-222-2575 | FAX: 831-597-0792
buildblock.com

BUILDDECK 10"

DATE/REV	11-17-09	SCALE	NTS	DETAIL SHEET
NOTES	BD-12+2			

CONSTRUCTION SHALL BE IN ACCORDANCE WITH ALL APPLICABLE LOCAL AND NATIONAL CODES. ALL DRAWINGS ARE SUBJECT TO CHANGE WITHOUT NOTICE.

5E

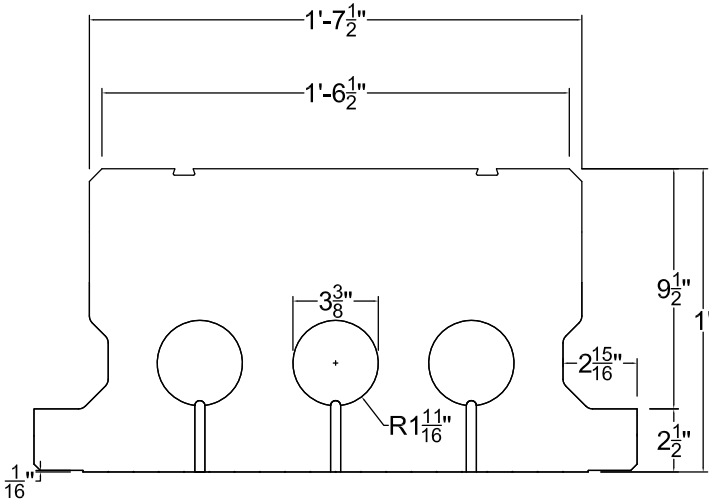

Note:
Due to variations in printers and print settings, this detail may or may not be to scale.

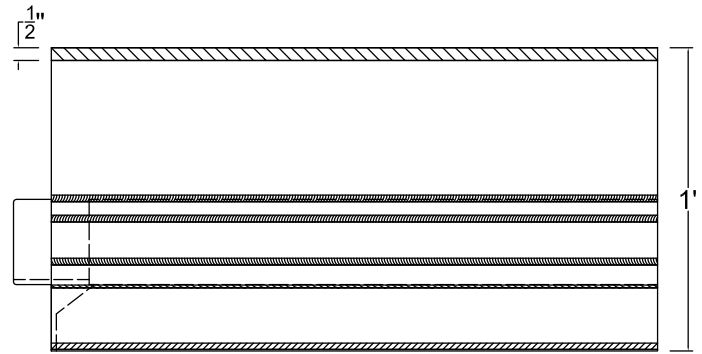

Note:
All concrete and steel design must be approved by the project specific Engineer of Record

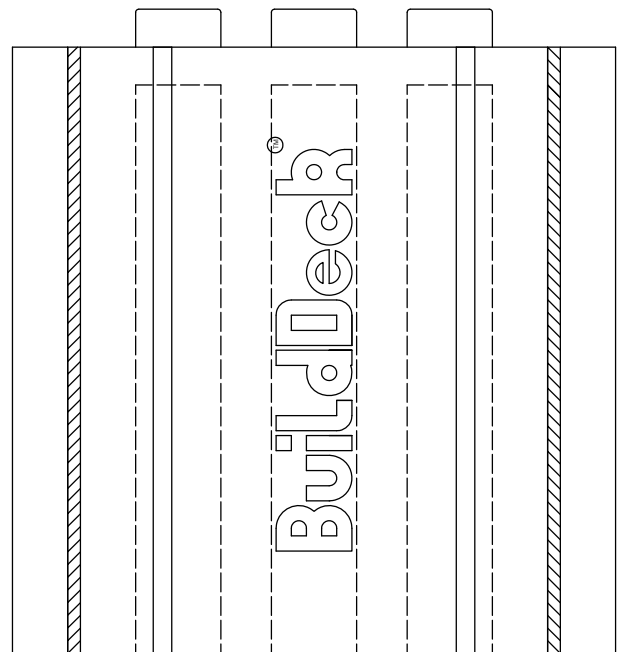
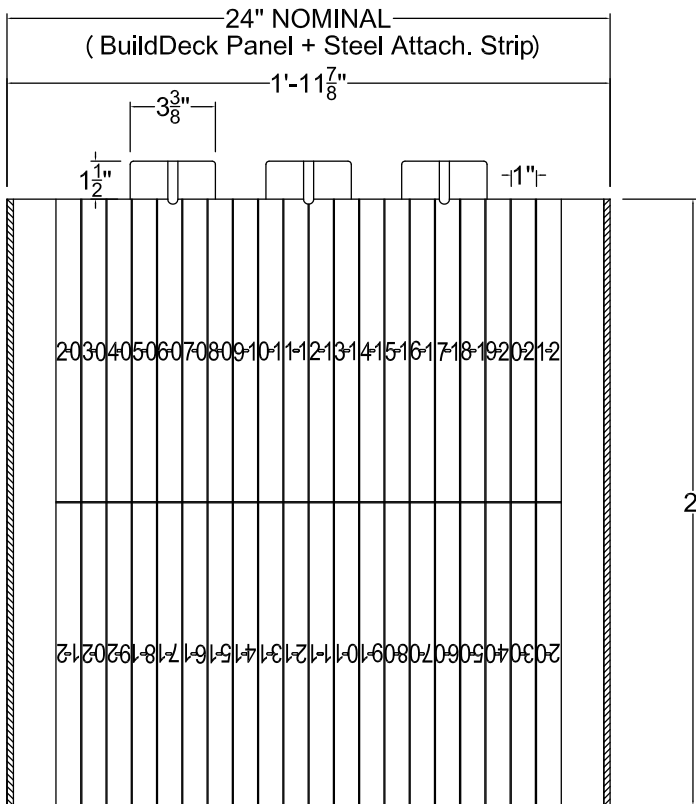
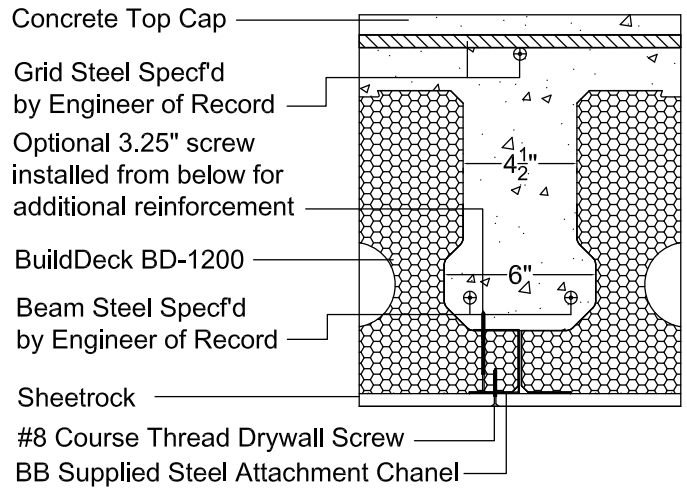

OFFICE: 405-840-3386 | TOLL FREE: 866-222-2575 | FAX: 831-597-0792
buildblock.com

BUILDDECK 12"

DATE/REV	11-17-09	SCALE	NTS	DETAIL SHEET
NOTES	BD-12+2			

CONSTRUCTION SHALL BE IN ACCORDANCE WITH ALL APPLICABLE LOCAL AND NATIONAL CODES. ALL DRAWINGS ARE SUBJECT TO CHANGE WITHOUT NOTICE.

5F

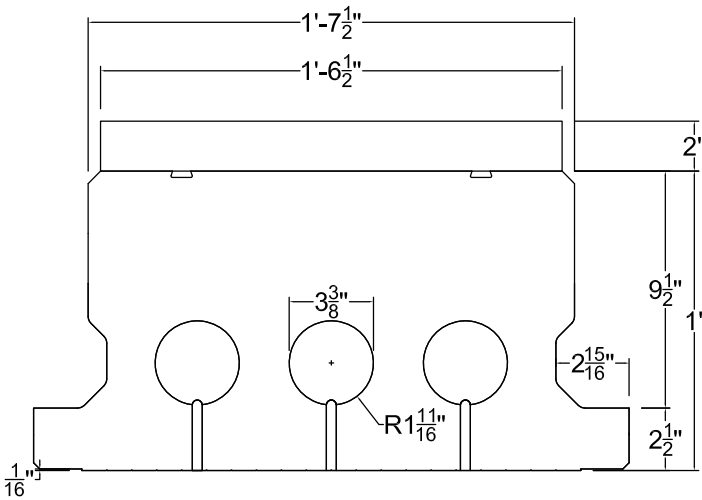

Note:
Due to variations in printers and print settings, this detail may or may not be to scale.

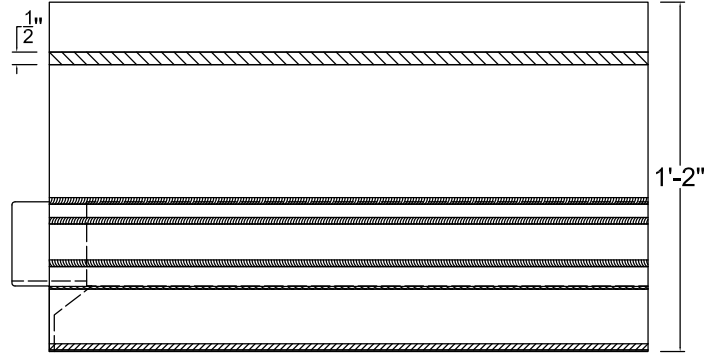

Note:
All concrete and steel design must be approved by the project specific Engineer of Record

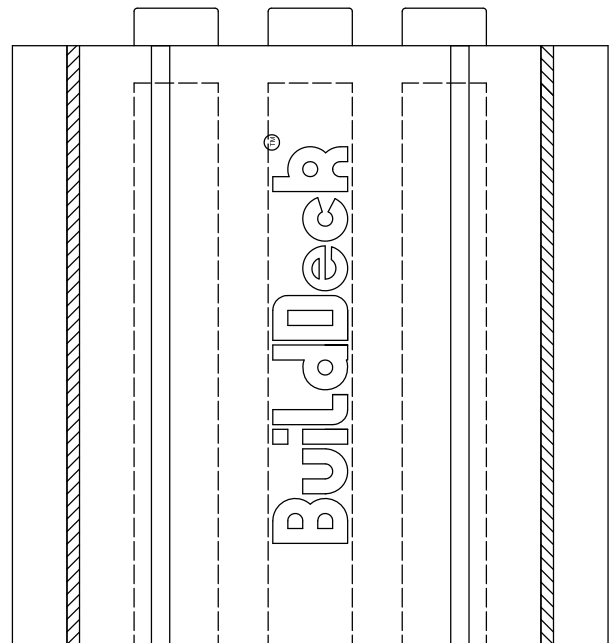
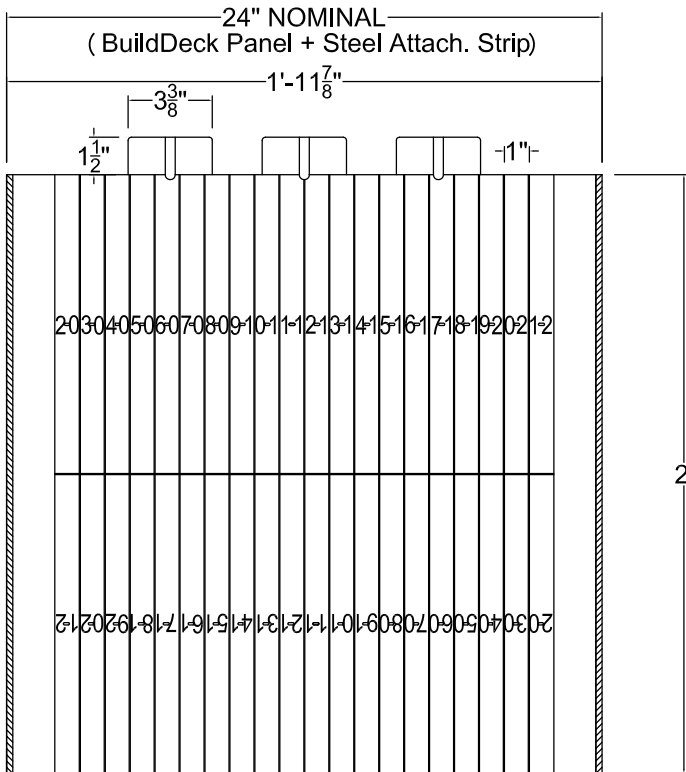
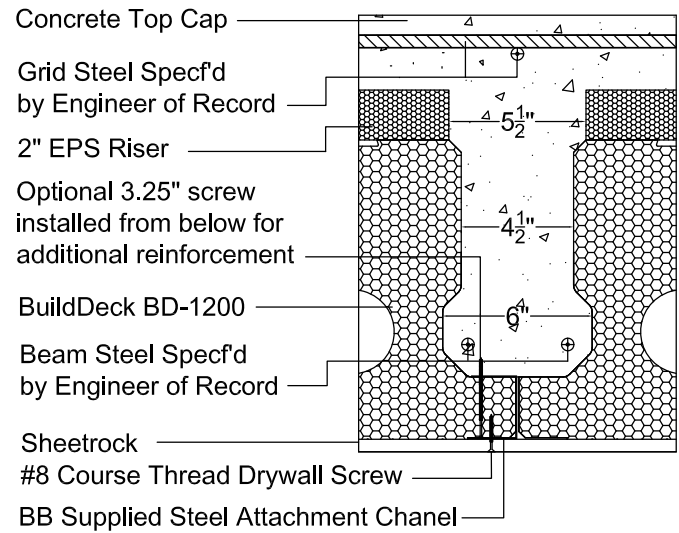

OFFICE: 405-840-3386 | TOLL FREE: 866-222-2575 | FAX: 831-597-0792
buildblock.com

BUILDDECK 12" + 2" FOAM TOP HAT

DATE/REV	11-17-09	SCALE	NTS	DETAIL SHEET
NOTES	BD-12+2			

CONSTRUCTION SHALL BE IN ACCORDANCE WITH ALL APPLICABLE LOCAL AND NATIONAL CODES. ALL DRAWINGS ARE SUBJECT TO CHANGE WITHOUT NOTICE.

5G

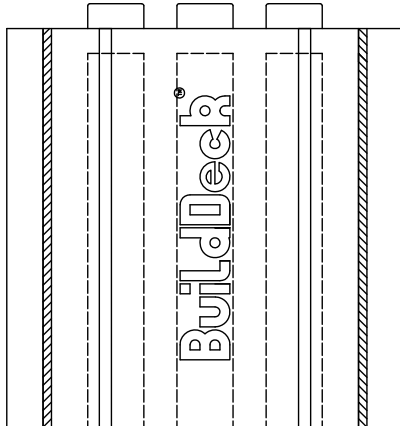
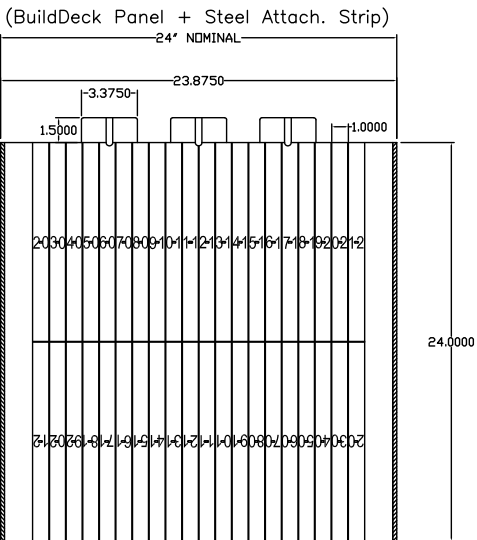
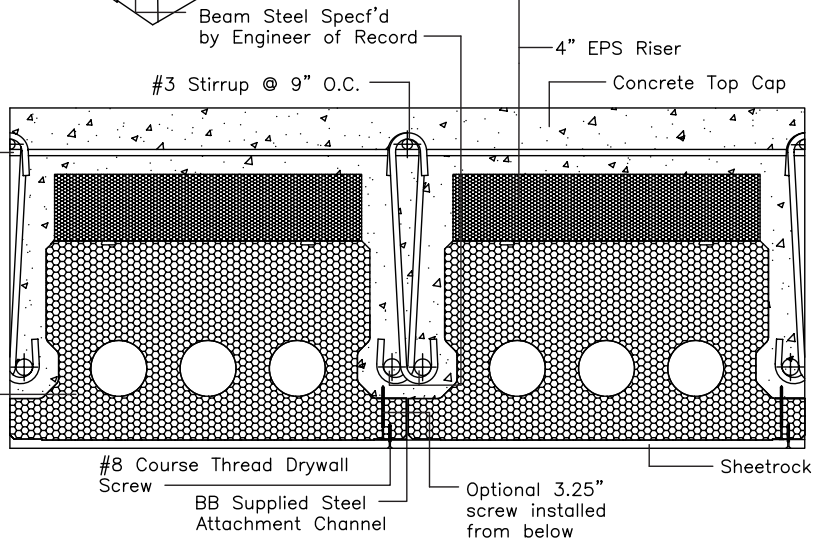
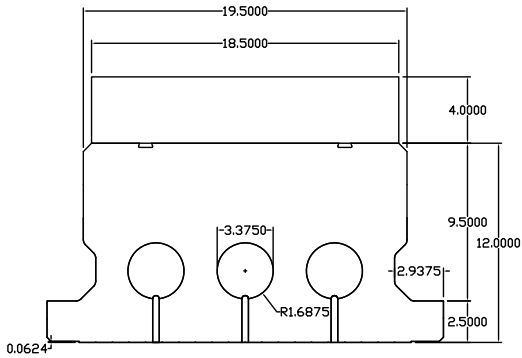
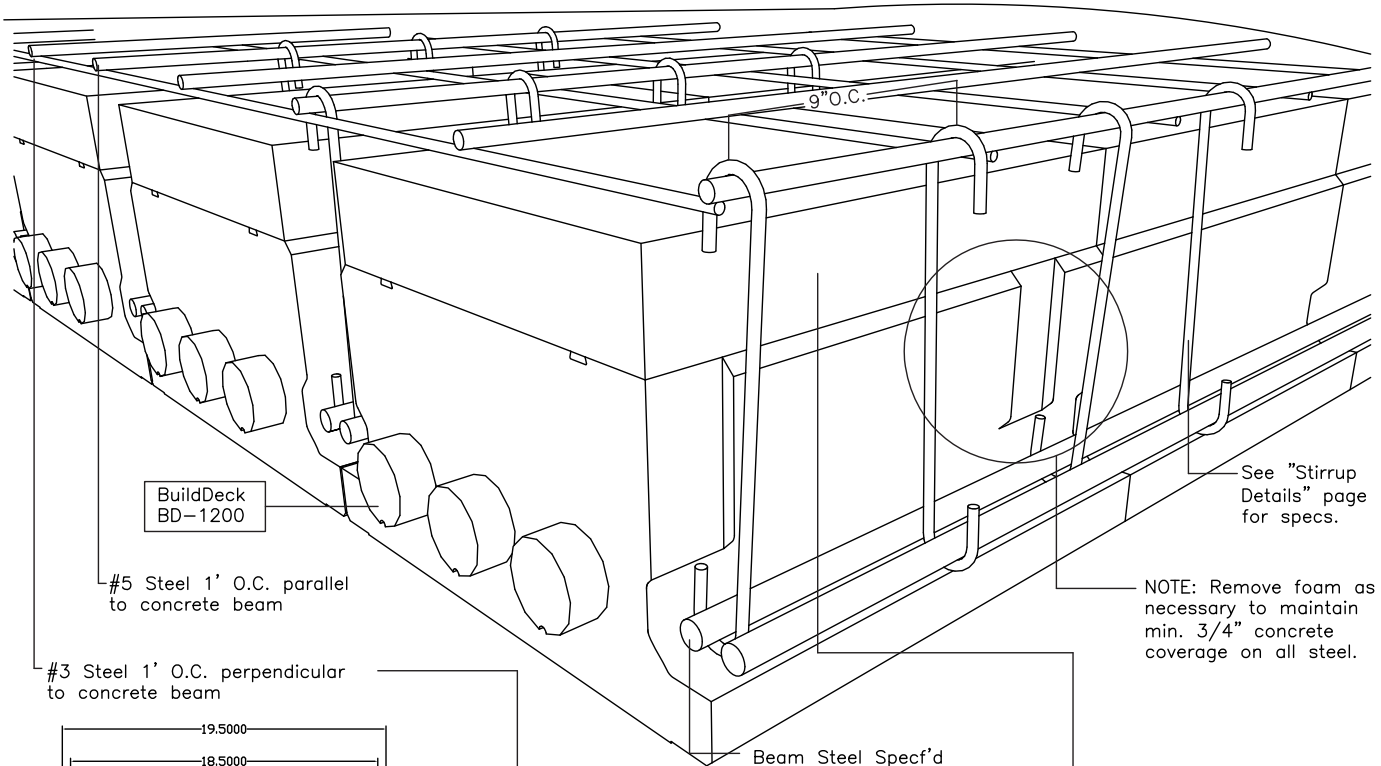

Note:
All concrete and steel design must be approved by the project specific Engineer of Record

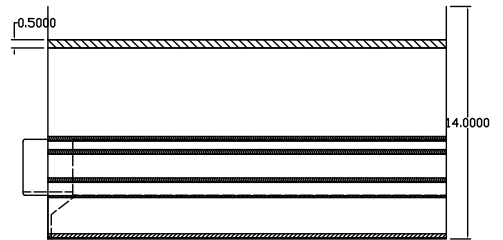

OFFICE: 405-840-3386 | TOLL FREE: 866-222-2575 | FAX: 831-597-0792
buildblock.com

BUILDDECK 12" + 4" FOAM TOP HAT

DATE/REV	11-17-09	SCALE	NTS	DETAIL SHEET
NOTES	BD-12+2			

CONSTRUCTION SHALL BE IN ACCORDANCE WITH ALL APPLICABLE LOCAL AND NATIONAL CODES. ALL DRAWINGS ARE SUBJECT TO CHANGE WITHOUT NOTICE.

5H

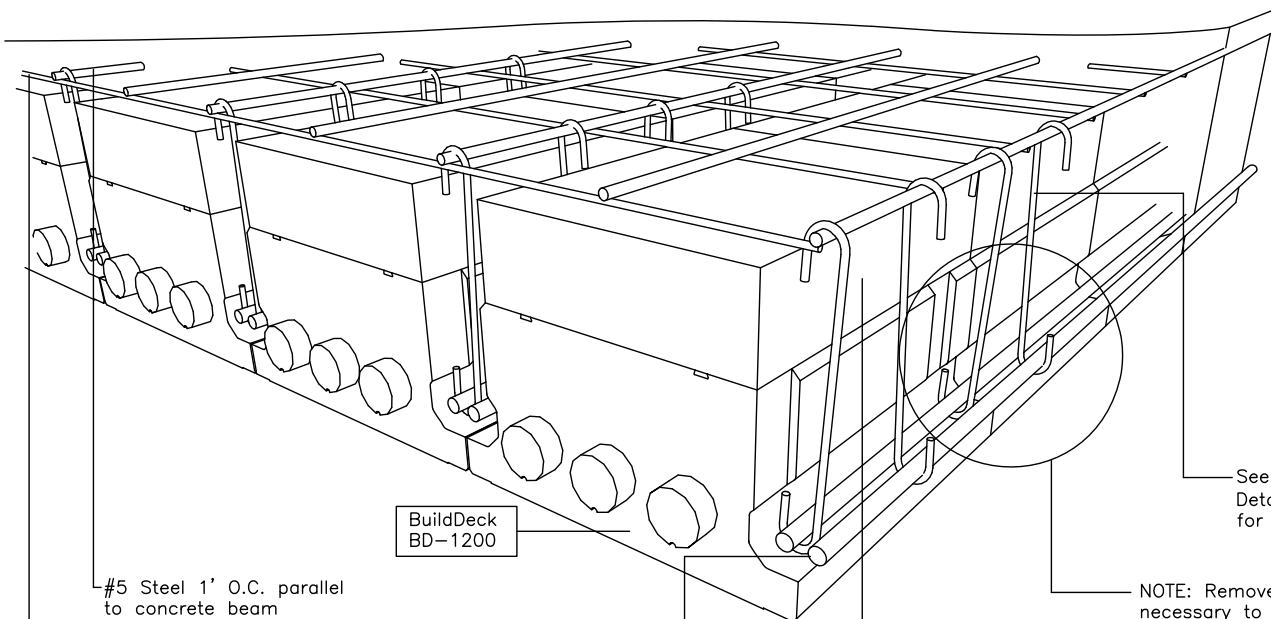

BuildDeck
BD-1200

#5 Steel 1' O.C. parallel
to concrete beam

See "Stirrup
Details" page
for specs.

NOTE: Remove foam as
necessary to maintain
min. 3/4" concrete
coverage on all steel.

#3 Steel 1' O.C. perpendicular
to concrete beam

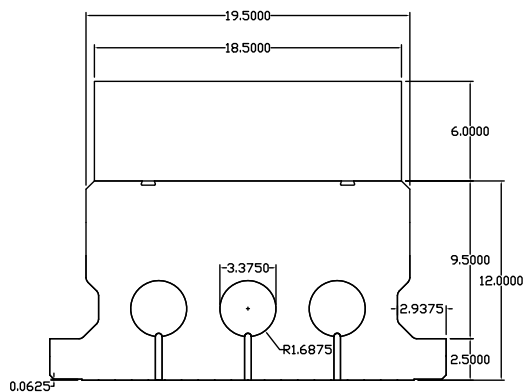

Beam Steel Spec'd
by Engineer of Record

6" EPS Riser

#3 Stirrup @ 9" O.C.

Concrete Top Cap

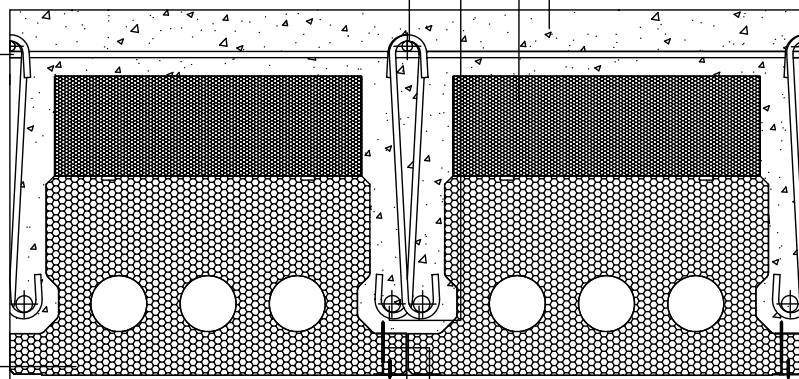

(BuildDeck Panel + Steel Attach. Strip)
24" NOMINAL

BuildDeck
BD-1200

#8 Course Thread Drywall Screw

Optional 3.25"
screw installed
from below

Sheetrock

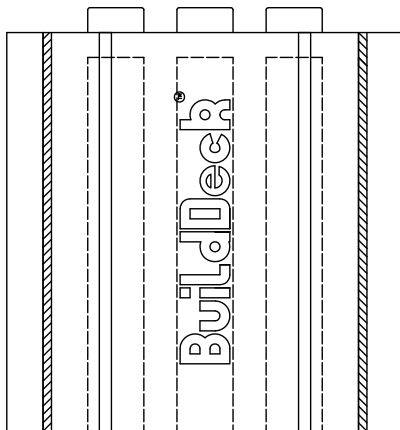
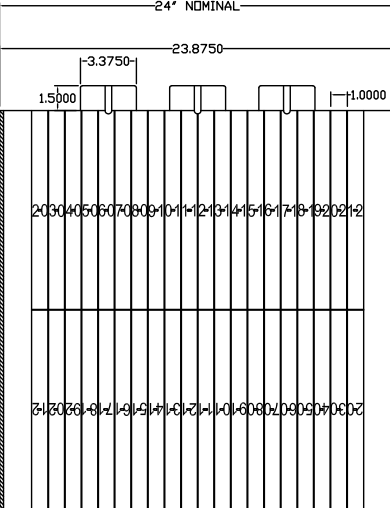

BB Supplied
Steel
Attachment
Channel

Note:
All concrete and steel
design must be
approved by the
project specific
Engineer of Record

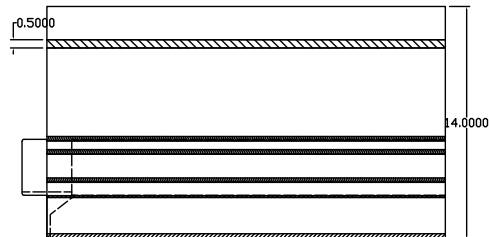

OFFICE: 405-840-3386 | TOLL FREE: 866-222-2575 | FAX: 831-597-0792
buildblock.com

BUILDDECK 12" + 6" FOAM TOP HAT

DATE/REV	11-17-09	SCALE	NTS	DETAIL SHEET
NOTES	BD-12+2			

CONSTRUCTION SHALL BE IN ACCORDANCE WITH ALL
APPLICABLE LOCAL AND NATIONAL CODES. ALL DRAW-
INGS ARE SUBJECT TO CHANGE WITHOUT NOTICE.

51

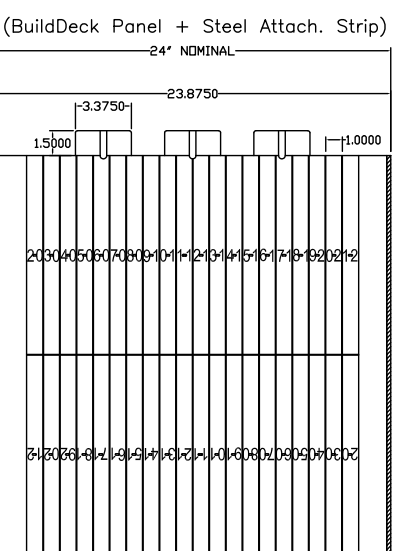
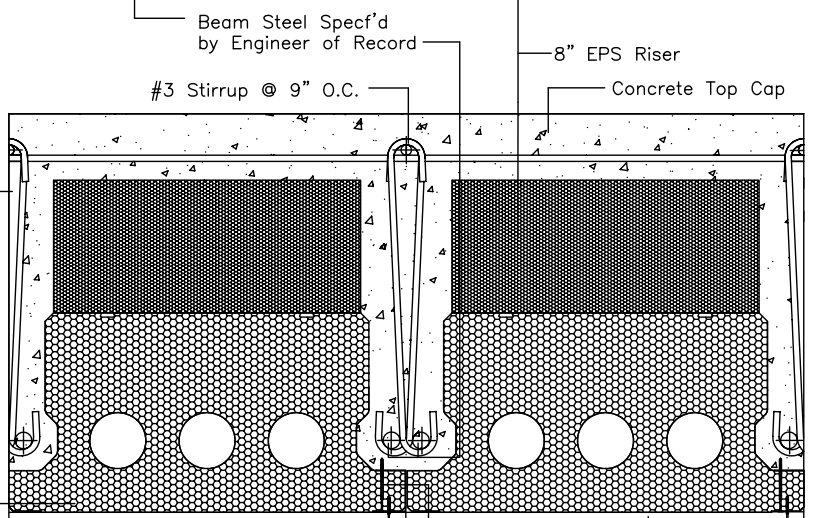
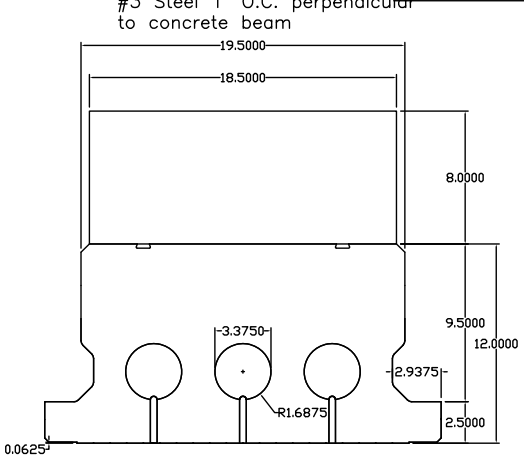
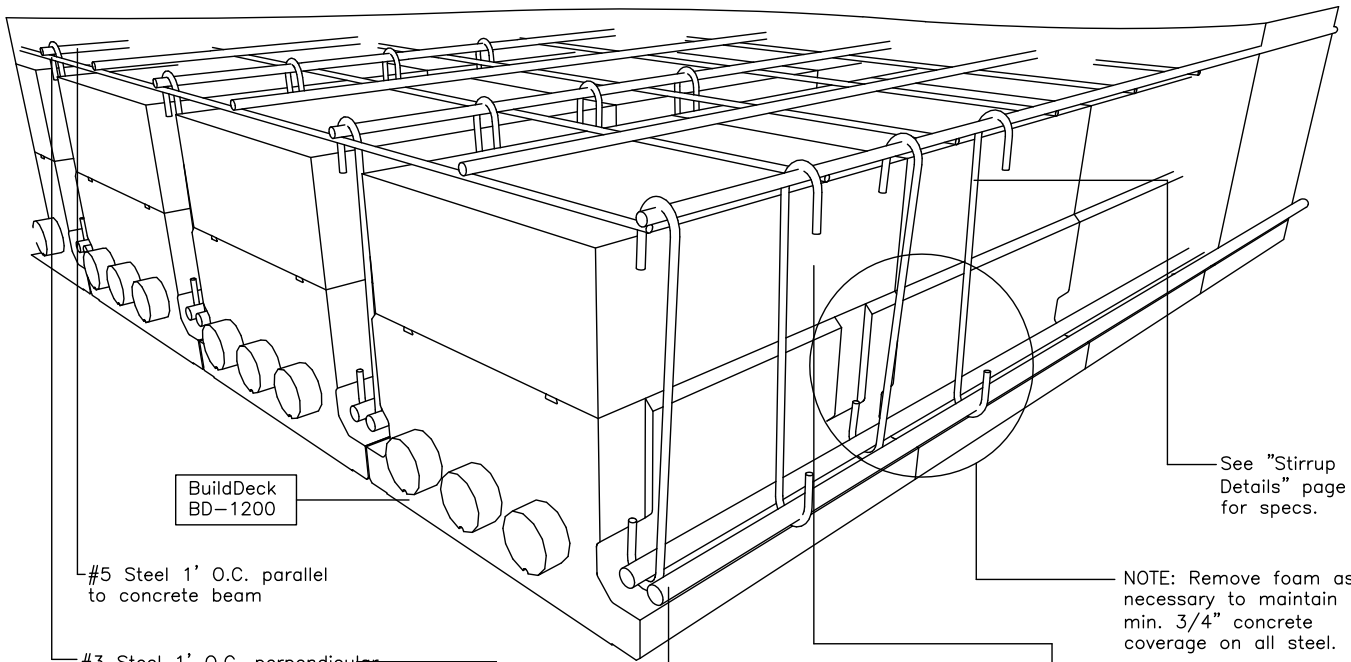

BuildDeck BD-1200

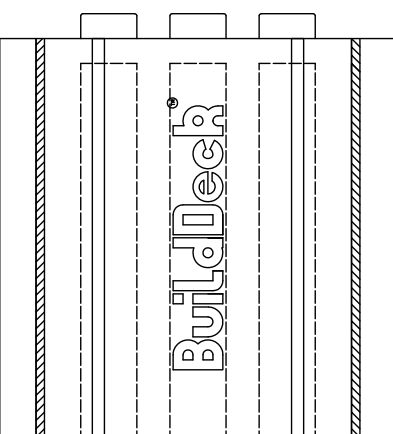

Note: All concrete and steel design must be approved by the project specific Engineer of Record

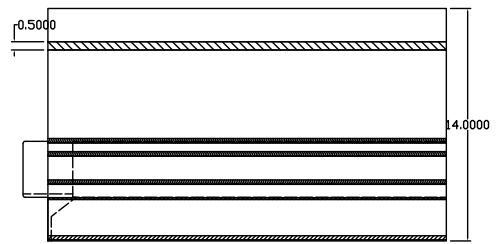

OFFICE: 405-840-3386 | TOLL FREE: 866-222-2575 | FAX: 831-597-0792
 buildblock.com

BUILDDECK 12" + 8" FOAM TOP HAT

DATE/REV	11-17-09	SCALE	NTS	DETAIL SHEET
NOTES	BD-12+2			

CONSTRUCTION SHALL BE IN ACCORDANCE WITH ALL APPLICABLE LOCAL AND NATIONAL CODES. ALL DRAWINGS ARE SUBJECT TO CHANGE WITHOUT NOTICE.

5J

RECOMMENDED STIRRUP
FOR BD-1200+4" RISER



RECOMMENDED STIRRUP
FOR BD-1200+6" RISER



RECOMMENDED STIRRUP
FOR BD-1200+8" RISER



Note:
All concrete and steel
design must be
approved by the
project specific
Engineer of Record



OFFICE: 405-840-3386 | TOLL FREE: 866-222-2575 | FAX: 831-597-0792
buildblock.com

BUILDDECK LONG SPAN STIRRUPS

DATE/REV	11-17-09	SCALE	NTS	DETAIL SHEET
NOTES	BD-12+2			

CONSTRUCTION SHALL BE IN ACCORDANCE WITH ALL APPLICABLE LOCAL AND NATIONAL CODES. ALL DRAWINGS ARE SUBJECT TO CHANGE WITHOUT NOTICE.

5K

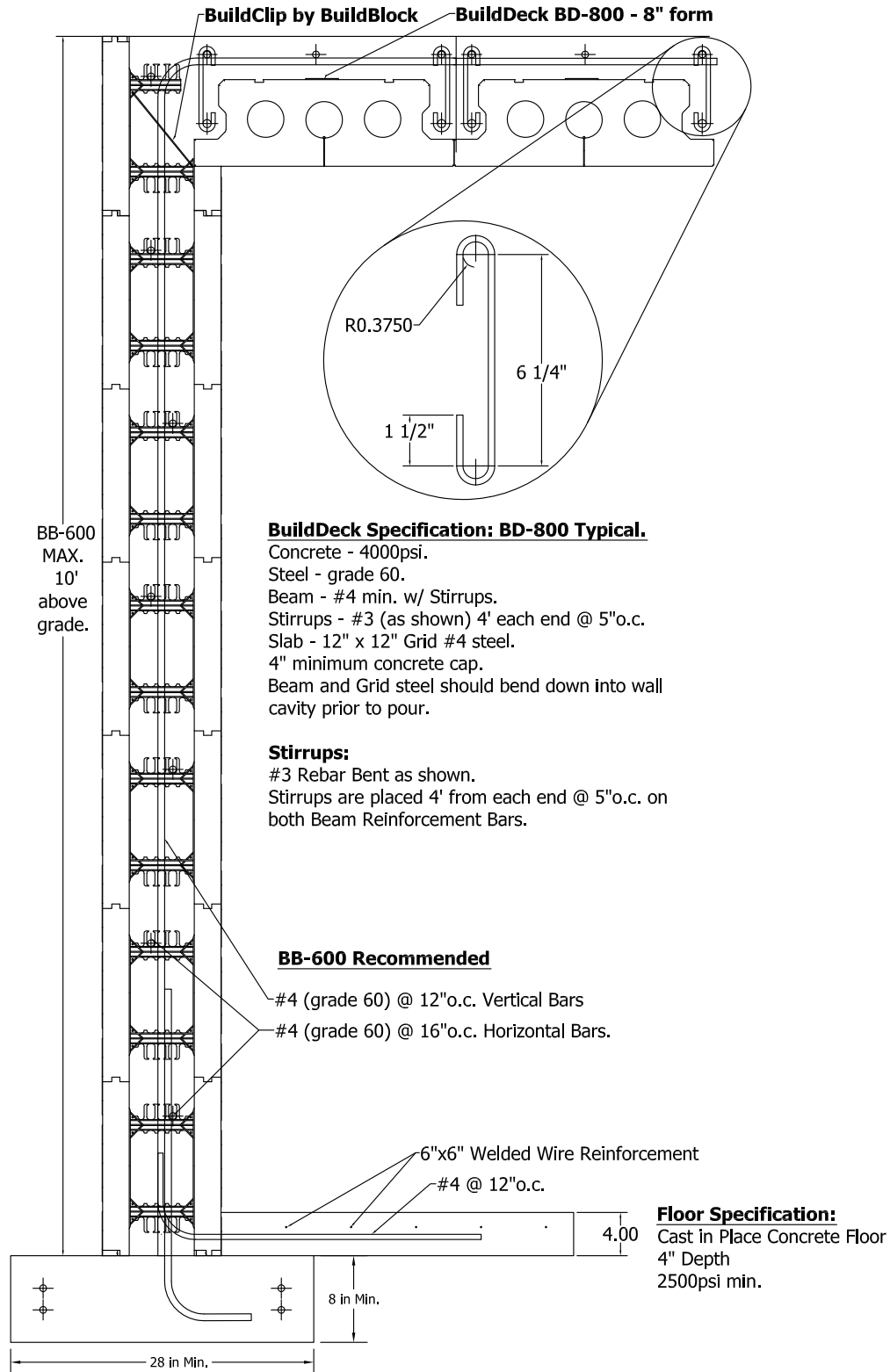

BuildDeck Specification: BD-800 Typical.

Concrete - 4000psi.
 Steel - grade 60.
 Beam - #4 min. w/ Stirrups.
 Stirrups - #3 (as shown) 4' each end @ 5"o.c.
 Slab - 12" x 12" Grid #4 steel.
 4" minimum concrete cap.
 Beam and Grid steel should bend down into wall cavity prior to pour.

Stirrups:

#3 Rebar Bent as shown.
 Stirrups are placed 4' from each end @ 5"o.c. on both Beam Reinforcement Bars.

BB-600 Recommended



#4 (grade 60) @ 12"o.c. Vertical Bars
 #4 (grade 60) @ 16"o.c. Horizontal Bars.

Floor Specification:

Cast in Place Concrete Floor
 4" Depth
 2500psi min.

Footing Specifications:

28" wide min.
 8" thick min.
 Base of footing min 12" below grade. (IRC R403.1.3.2)
 Top of footing must be at frost line. (IRC R403.1.4.1)

	BUILDDECK SAFE ROOM WALL SECTION DETAIL			DETAIL SHEET	
	DATE/REV	11-17-09	SCALE	NTS	
NOTES	BD-12+2				
OFFICE: 405-840-3386 TOLL FREE: 866-222-2575 FAX: 831-597-0792 buildblock.com		CONSTRUCTION SHALL BE IN ACCORDANCE WITH ALL APPLICABLE LOCAL AND NATIONAL CODES. ALL DRAWINGS ARE SUBJECT TO CHANGE WITHOUT NOTICE.			



BUILDDECK ROOF & FLOOR DECKING SYSTEM DESIGN, ENGINEERING, AND INSTALLATION MANUAL

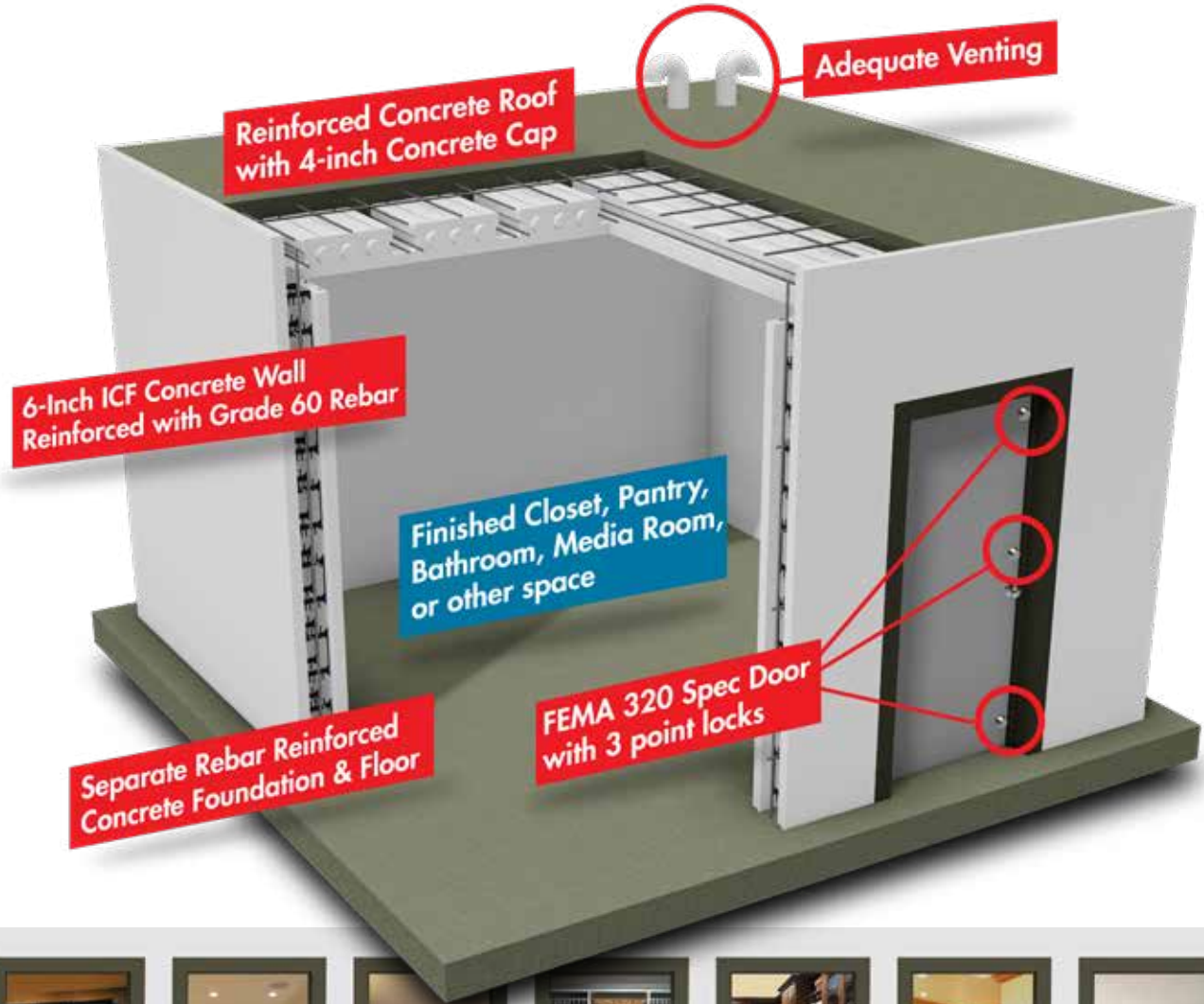

SECTION 7: BUILDDECK ENGINEERING



bridge, highway & rail engineering
 entertainment engineering
 subaqueous investigation
 civil & site engineering
 structural design
 marine facilities
 geotechnics
 surveying
 forensics

September 22, 2009

BuildBlock Building Systems, LLC
 9701 N. Broadway Extension
 Oklahoma City, OK 73114

Attn: Mr. Justin Wallace

Re: BuildBlock BuildDeck Shoring System
 MEG File: 109735.00

Dear Mr. Wallace:

This letter is presented as McLaren Engineering Group's analysis of the proposed shoring system of the BuildDeck floor system. The BuildDeck floor system consists of 2' x 2' EPS panels with concrete poured on top and in between two adjacent panels, forming a web and a flange. The layout of the shoring system was proposed by BuildBlock and consists of the following: wooden 2x or 4x posts spaced at 6' on center in both directions that support 2x girders that support 2x joists spaced at 2' on center. Some girders may be double-ply. Blocking in between these plies may range from 1/2" thick plywood to 1-1/2" thick 2x material; whatever is needed to allow for the connection to the post. McLaren understands that there are three sizes of BuildDeck EPS panels that may be used; the panel that requires the most volume of concrete has been used for design.

The following are descriptions of the different abbreviations used in this letter.

SYP – Southern Yellow Pine
 DFL (N) – Douglas Fir-Larch (North) or Douglas Fir-Larch
 L.L. – Live Load

Table 1 summarizes the allowable live load for the four various shoring framing systems.

JOIST TYPE	GIRDER TYPE	INTERIOR POST	EXTERIOR POST	ALLOWABLE L.L.
2X6 SYP #2	2X8 SYP #2	4X4 SYP STANDARD ^{2 3}	2X6X10' SYP #2 ¹	50 psf
2X6 DFL (N) #2 ⁴	2X8 DFL (N) #2 ⁴	4X4 DFL (N) #2 ^{2 3 4}	2X6X10' DFL (N) #2 ⁴	32 psf ⁴
2X8 SYP #2	2X10 SYP #2	4X4 SYP STANDARD ^{2 3}	4X4 SYP STANDARD ^{2 3}	90 psf
2X8 DFL (N) #2	2X10 DFL (N) #2	4X4 DFL (N) #2 ^{2 3}	4X4 DFL (N) #2 ^{2 3}	79 psf

Table 1 - Allowable Loads

Table 1 Notes:

- a Note that post height doesn't include height of any jacking system employed.
- 1 2x6x10' post must be braced in the weak axis at mid-height. An acceptable bracing practice would be to screw the post to the ICF wall at 12" on center. If post height is 8' or less, acceptable post is as shown or 2x8x8' unbraced.
- 2 4X6 post may be substituted for 4x4 post.
- 3 Construction, standard, and #2 grades are interchangeable if same species is used.
- 4 This system that employs 2x6 DFL (N) #2 joists may only be used where construction type is explicitly light duty.

Offices: New York, Maryland, Florida, Connecticut, California

Licensed in:

Arizona • Arkansas • California • Colorado • Connecticut • Delaware • District of Columbia • Florida • Georgia • Idaho • Illinois
 Indiana • Kansas • Kentucky • Louisiana • Maryland • Massachusetts • Michigan • Minnesota • Mississippi • Missouri • Nebraska
 Nevada • New Hampshire • New Jersey • New York • North Carolina • Ohio • Oklahoma • Oregon • Pennsylvania • Rhode
 Island • South Carolina • Tennessee • Texas • Trinidad & Tobago • Utah • Vermont • Virginia • Washington • West Virginia •
 Wisconsin

M. G. McLAREN, P.C.

5728 Major Blvd, Suite 603
 Orlando, FL 32819
 Phone (407) 354-5411
 Fax (407) 354-3466

e-mail:
 florida@mgmclaren.com
 On the web: www.mgmclaren.com

Table 2 summarizes the required Simpson (or other) connectors to be used.

MEMBERS	REQUIRED LOAD	CONNECTOR	AVAILABLE LOAD
2X6 JOIST TO 2X8 GIRDER	684 lb	LUS26 W/ (4) 10d NAILS	830 lb
2X8 JOIST TO 2X10 GIRDER	930 lb	LUS28 W/ (6) 10d NAILS	1055 lb
BEAM TO 4X COLUMN	STABILITY	(2) LPC4Z' OR ELLIS CAP	STABILITY
BEAM TO 2X6 COLUMN	STABILITY	LPC6Z'	STABILITY
GIRDER TO 2X4 BLOCKS	STABILITY	(4) 16d NAILS	STABILITY

Table 2 - Required Connectors

Table 2 Notes:

a Values have been taken from the 2009-2010 Simpson Wood Construction Connectors catalog.

1 Use (8) 10d nails into the beam and (8) 10d nails into the post.

The following are recommendations that must be followed to ensure that the shoring system functions properly:

- 1) ***The shoring system must be somehow braced laterally in the direction parallel to the joist span. The system is considered braced if exterior posts are screwed to an ICF wall.***
- 2) All instructions and precautions for Simpson connectors and Ellis screw jacks and post caps must be followed.
- 3) All joists must be snug fit against the joist hanger on all four sides of contact.

Included below are pages 11, 19 and 20 from SEI/ASCE37-02 which is a standard for the design loads on structures during construction. Page 11 includes definitions and the table on page 19 classifies construction into four different types: very light duty, light duty, medium duty, and heavy duty. Each type has an associated uniform load which does not include dead load, construction dead load, or fixed material loads, so this uniform load can be considered a live load in the BuildDeck application. There are descriptions of these four types of construction to the right of the table and onto page 20. Two characteristics of heavy duty construction are concrete transport and placement using motorized buggies and material storage.

Note that in no case should heavy duty construction take place on the proposed shoring system; however it is acceptable to store limited quantities of 20 gage sheet metal and EPS panels over the girders. Any storage over the joists should be kept very minimal at all times.

It is the opinion of McLaren that the main construction type for the BuildDeck application is medium duty and therefore most systems require the use of a live load of 50 psf. Therefore, the shoring framing system employing 2x6 DFL (N) #2 joists should not be used unless construction type is explicitly light duty, which may be the case in some shoring applications.



M. G. MCLAREN, P.C.

SEI/ASCE 37-02

STANDARD

4.0 CONSTRUCTION LOADS

4.1 General Requirements

The provisions of this section shall be used to define the construction loads for the design of both temporary structures and permanent structures subject to loads during construction. These loads are to be combined with other applicable loads per the requirements of Section 2.

When a construction loading is covered in another document that is acceptable to the authority having jurisdiction and written to address a specific material or method of construction, the more applicable document shall be permitted to be followed.

Stairs, ladders, and elevators are not addressed in this standard.

4.1.1 Definitions

Construction loads: those loads imposed on a partially completed or temporary structure during and as a result of the construction process. Construction loads include, but are not limited to, materials, personnel, and equipment imposed on the temporary or permanent structure during the construction process.

Construction dead load, C_D : the dead load of temporary structures that are in place at the stage of construction being considered. The dead load of the permanent structure, either partially complete or complete, is not included in C_D ; the dead load of the permanent structure is defined as *dead load, D* , in Section 3.1.

Individual personnel load: a concentrated load of 250 lb (1.1 kN) that includes the weight of one person plus equipment carried by the person or equipment that can be readily picked up by a single person without assistance.

Working surfaces: floors, decks, or platforms of temporary or partially completed structures which are or are expected to be subjected to construction loads during construction.

4.2. Material Loads

The material dead loads consist of two categories:

1. fixed material loads (FML)
2. variable material loads (VML)

The FML is the load from materials that is fixed in magnitude. The VML is the load from materials that varies in magnitude during the construction process. If the local magnitude of a material load varies during the

COMMENTARY

C4.0 CONSTRUCTION LOADS

C4.1 General Requirements

The loads for some temporary structures, such as those that retain lateral pressures of earth, are not defined in Section 4; refer to Section 5 for lateral pressures of earth.

Standards and other documents applicable to specific materials or methods of construction have been developed and are recognized and used extensively.

C4.2. Material Loads

This section separates material dead loads into two categories: FML and VML, which are separated to permit the use of an appropriate load factor for each category in strength design. This approach recognizes the difference in the variability of the load between the two categories.

This section addresses the loads from materials and is not intended to apply to equipment loads. Per-

11

SEI/ASCE 37-02

SEI/ASCE 37-02

STANDARD

COMMENTARY

4.8 Application of Loads

C4.8 Application of Loads

Construction loads depend very much on the specific planning and processes of construction. This section includes rules for applying and combining the various loads, as well as traditional minimums for several common construction processes.

4.8.1 Combined Loads

The design construction load shall include the critical combination of personnel, equipment, and material loads.

C4.8.1 Combined Loads

The combination of the various forms of construction loads, materials, personnel, and equipment is an important step in engineering for construction, requiring careful application of professional judgment.

4.8.1.1 Working Surfaces. Structures supporting working surfaces as defined in Section 4.1 shall be designed for the combined material, personnel, equipment, and other applicable construction loads.

C4.8.1.1 Working Surfaces. It is traditional to design many working surfaces for a uniformly distributed load that is meant to include all construction loads, except for materials in their final position.

When the construction operation fits the definition in Table 2, the designer is permitted to design for the tabulated uniform loads as the vertical load from the combination of personnel, equipment, and material in transit or staging. When the construction operation does not fit the definitions in Table 2, the design shall be for the actual loads. Concentrated loads shall be considered separately.

Temporary structures have often been designed, advertised, and specified by the light, medium, and heavy duty ratings given in Table 2. This standard also applies to partially completed structures, and the same terminology is adopted. Different styles of construction and different segments of the construction industry have different traditions for design loads on partially completed structures during construction, and this section of the standard is an attempt to unify the industry on a common basis.

Examples of construction operations that have traditionally been designed for the loads given in the table are

Table 2 Classes of Working Surfaces for Combined Uniformly Distributed Loads

Operational Class	Uniform Load ^a psf (kN/m ²)
Very light duty: sparsely populated with personnel; hand tools; very small amounts of construction materials	20 (0.96)
Light duty: sparsely populated with personnel; hand operated equipment; staging of materials for lightweight construction	25 (1.20)
Medium duty: concentrations of personnel; staging of materials for average construction	50 (2.40)
Heavy duty: material placement by motorized buggies; staging of materials for heavy construction	75 (3.59)

^a Loads do not include dead load, D; construction dead load, C_D; or fixed material loads, C_{FML}.

Very light duty:

- Roofing, reroofing, excepting situations with stockpiles of ballast
- Access catwalks
- Painting, caulking
- Maintenance using hand tools

Light duty:

- Light frame construction
- Concrete transport and placement by hose and concrete finishing with hand tools

Medium duty:

- Concrete transport and placement by buckets, chutes, or handcarts
- Concrete finishing using motorized screeds
- Masonry construction with tile or hollow lightweight concrete units
- Structural steel erection or concrete reinforcing steel placement



DESIGN LOADS ON STRUCTURES DURING CONSTRUCTION

STANDARD

COMMENTARY

4.8.1.2 Specification of Temporary Structures. When temporary structures are specified by load name, the names of the load class and the magnitude of design loads shall be as given in Table 2.

4.8.2 Partial Loading

The full intensity of the construction load applied only to a portion of the length of a structure or member shall be considered if it produces a more unfavorable effect than the same intensity applied over the full length of the structure or member.

4.8.3 Reduction in Construction Loads

4.8.3.1 Material Loads. No reduction is allowed for fixed or variable material loads, except to the extent that small amounts of material in transit or staging are included in uniformly distributed personnel, equipment, and material loads, such as those in Table 2.

4.8.3.2 Personnel and Equipment Loads. When justified by an analysis of the construction operations, members having an influence area of 400 ft² (37.16 m²) or more may be designed for a reduced uniformly distributed personnel and equipment load determined by applying the following formula:

$$C_P = L_o (0.25 + 15/\sqrt{A_f}) \quad (4-6)$$

$$C_{P\ SI} = L_o (0.25 + 4.57/\sqrt{A_f}) \quad (4-6\ SI)$$

Heavy duty:

Concrete transport and placement using motorized buggies

Masonry of brick or heavy-weight concrete units

Material storage

Conflicts between provisions of this section and those in ASCE 3-91 and ASCE 9-91 are acknowledged.

Following are examples of working surfaces that do not fall under Table 2:

Roofs for which design is controlled by building code live load or snow loads that are less than values in Table 2.

Attics or hung ceilings that provide access for maintenance, installation of utilities, and emergency services such as firefighters.

These working surfaces must be addressed in accordance with Sections 4.8.1.1 and 4.8.4.

C4.8.1.2 Specification of Temporary Structures. This requirement will encourage uniformity in terminology for capacity of scaffolds and similar structures.

C4.8.2 Partial Loading

Partial-length loads on a beam or truss may produce higher shear on a portion of the span than a full-length load. Checkerboard loadings on floors and multistory frames produce the highest positive and negative moments. Cantilevers cannot rely on a possible construction load on the anchor span for equilibrium. ASCE 7-95 describes other possible conditions of designing members or floors for partial loading.

C4.8.3.2 Personnel and Equipment Loads. Uniformly distributed loads are a convenient substitute for computing the combined effect of several concentrated loads. As such they are generally calibrated to a particular area. For smaller areas, the concentrated loads control structural design. The nature of transient concentrated loads, such as personnel and equipment, is that their spacing is not uniform, thus, for areas larger than the calibration area, the uniform load may be unnecessarily conservative.

BuildBlock BuildDeck Shoring
MEG File No. 109735.00

Page 6
August 25, 2009

If you have any questions and or comments please contact me at (407) 354-5411 or via email at roleck@mgmclaren.com.

Very truly yours
The Office of
McLaren Engineering Group
M.G. McLaren, P.C.



Robert F. Oleck, Ph.D., P.E.
Regional Director

cc: MGM, WRM, DWH,

P:\PROJ109\109735-BUILDBLOCK FLOORDECK SHORING\3. CORRESPONDENCE\LETTERS\SENTLTR01-J.WALLACE-109735-092209.DOC



M. G. MCLAREN, P.C.

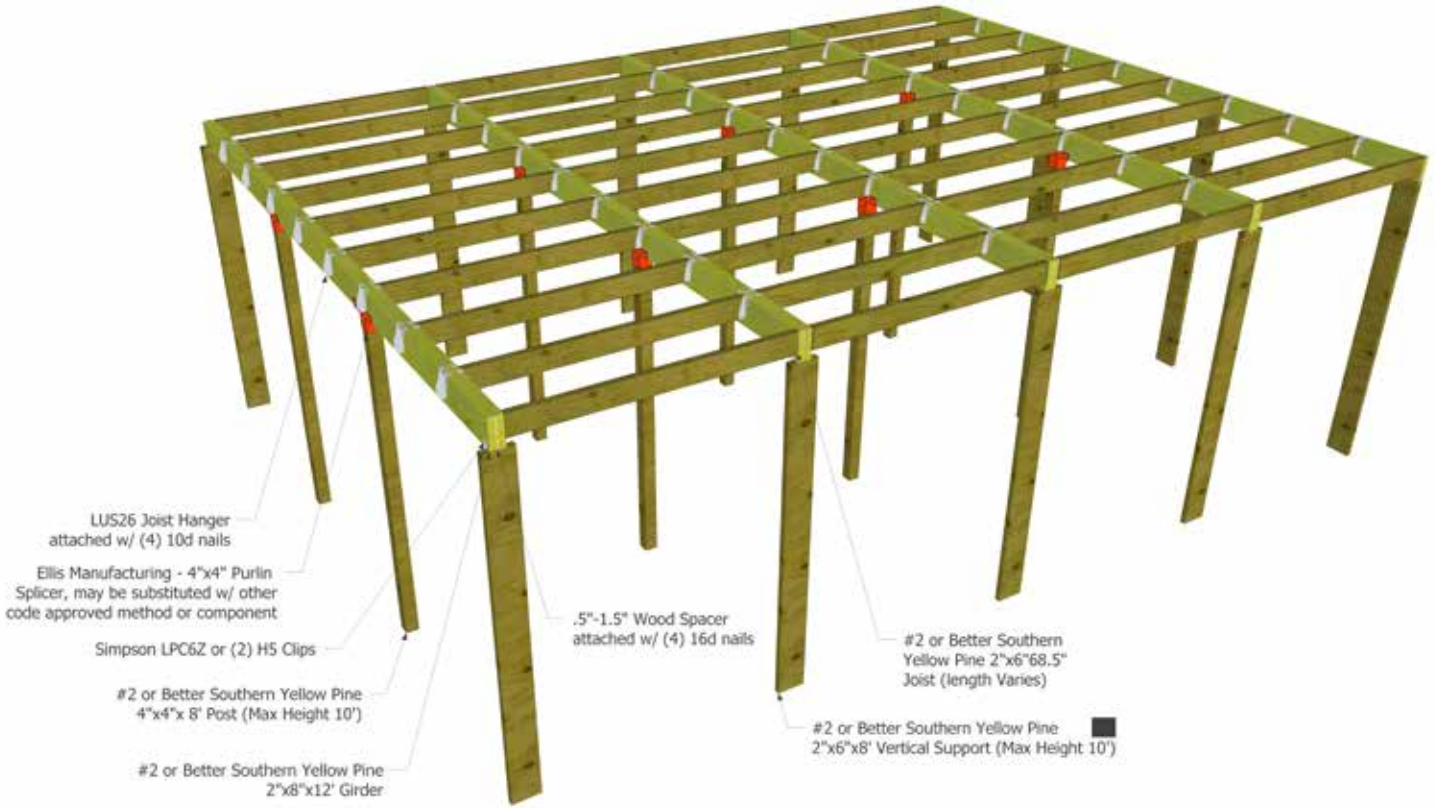

OFFICE: 405-840-3386 | TOLL FREE: 866-222-2575 | FAX: 831-597-0792
 buildblock.com

BUILDDECK SHORING DETAIL

DATE/REV	11-17-09	SCALE	NTS	DETAIL SHEET
----------	----------	-------	-----	--------------

NOTES	BD-12+2
-------	---------

CONSTRUCTION SHALL BE IN ACCORDANCE WITH ALL APPLICABLE LOCAL AND NATIONAL CODES. ALL DRAWINGS ARE SUBJECT TO CHANGE WITHOUT NOTICE.

0A

BuildDeck - 8" Deck with 2" Concrete Cap

Span Length (Ft.)		8	9	10	11	12	13	14	15	16	17	18	19	20
Qty. Rein.	Bar Size													
Steel Rqd.	Designation													
2	#4	357	271	197	145	108	80	58	42	29	19	10	3	X
2	#5	443	312	226	166	123	92	68	49	35	24	14	6	X
2	#6	516	360	259	190	141	105	79	58	42	29	19	10	4
2	#7	593	412	294	215	160	120	90	67	50	35	24	15	8

Live Load

Assumptions: Concrete Design Yield Strength $F_c = 4000$ psi
 Steel Yield Strength $F_y = 60$ ksi
 Addtl. Applied Dead Ld. Incl. DL = 15 psf
 Long Term Deflection Def < L/480
 Stirrup Reinforcement in Beam #3 rebar, 4 ft each end @ 5" O.C.
 Slab Reinforcement 10" X 10" Grid #4 Steel

ALL TABLES PROVIDED FOR ESTIMATION PURPOSES ONLY. ALL DESIGNS MUST BE REVIEWED AND APPROVED BY THE PROJECT SPECIFIC ENGINEER OF RECORD.



OFFICE: 405-840-3386 | TOLL FREE: 866-222-2575 | FAX: 831-597-0792
 buildblock.com

BUILDDECK 8" +2" CONCRETE CAP TABLE



DATE/REV: _____ SCALE: _____ NTS: _____

NOTES

CONSTRUCTION SHALL BE IN ACCORDANCE WITH ALL APPLICABLE LOCAL AND NATIONAL CODES. ALL DRAWINGS ARE SUBJECT TO CHANGE WITHOUT NOTICE.

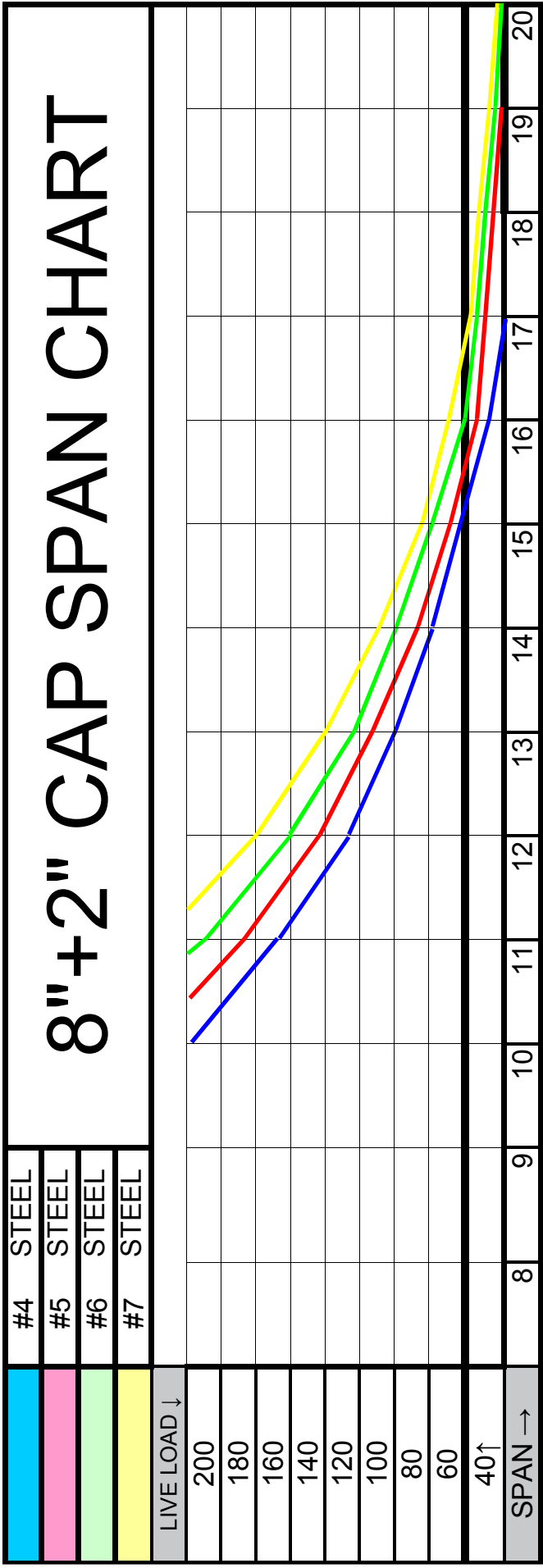
1-A



			BUILDDECK 8" +2" CONCRETE CAP CHART		DATE/REV SCALE NTS	DETAIL SHEET
	OFFICE: 405-840-3386 TOLL FREE: 866-222-2575 FAX: 831-597-0792 buildblock.com		CONSTRUCTION SHALL BE IN ACCORDANCE WITH ALL APPLICABLE LOCAL AND NATIONAL CODES. ALL DRAWINGS ARE SUBJECT TO CHANGE WITHOUT NOTICE.			

BuildDeck - 8" Deck with 3" Concrete Cap

Span Length (Ft.)		8	9	10	11	12	13	14	15	16	17	18	19	20	21	22
Qty. Rein. Steel Rqd.	Bar Size Designation	Live Load														
2	#4	414	315	244	192	152	117	88	65	48	33	22	13	5	X	X
2	#5	618	437	318	236	178	135	103	78	58	41	29	18	10	3	X
2	#6	730	511	369	274	206	156	119	91	68	51	37	25	16	8	X
2	#7	849	591	425	314	236	179	137	106	81	60	45	32	22	14	6

Assumptions: Concrete Design Yield Strength $F'_c = 4000$ psi
 Steel Yield Strength $F'_y = 60$ ksi
 Addtl. Applied Dead Ld. Incl. $DL = 15$ psf
 Long Term Deflection $Def < L/480$
 Stirrup Reinforcement in Beam #3 rebar, 4 ft each end @ 5" O.C.
 Slab Reinforcement 12" x 12" Grid #4 Steel

ALL TABLES PROVIDED FOR ESTIMATION PURPOSES ONLY. ALL DESIGNS MUST BE REVIEWED AND APPROVED BY THE PROJECT SPECIFIC ENGINEER OF RECORD.



BUILDING SYSTEMS



OFFICE: 405-840-3386 | TOLL FREE: 866-222-2575 | FAX: 831-597-0792
 buildblock.com

BUILDDECK 8" +3" CONCRETE CAP TABLE

DATE/REV	SCALE	NTS	DETAIL SHEET
NOTES			1-C

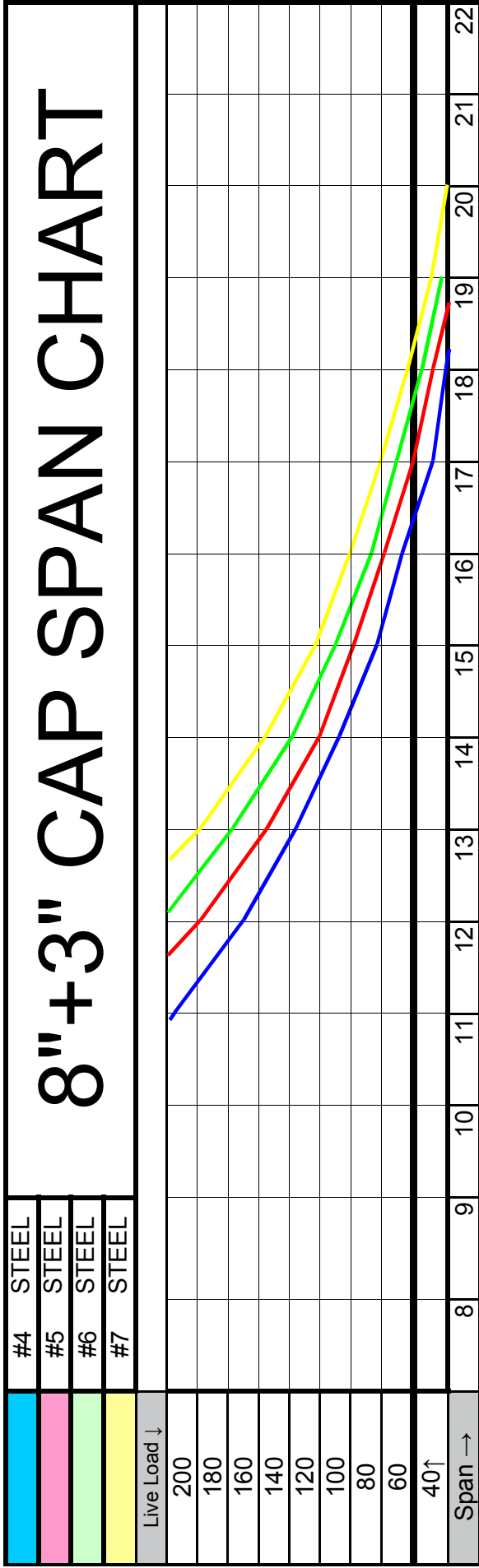
CONSTRUCTION SHALL BE IN ACCORDANCE WITH ALL APPLICABLE LOCAL AND NATIONAL CODES. ALL DRAWINGS ARE SUBJECT TO CHANGE WITHOUT NOTICE.





		BUILDDECK 8" +3" CONCRETE CAP CHART DATE/REV: _____ SCALE: _____ NTS NOTES: _____ CONSTRUCTION SHALL BE IN ACCORDANCE WITH ALL APPLICABLE LOCAL AND NATIONAL CODES. ALL DRAWINGS ARE SUBJECT TO CHANGE WITHOUT NOTICE.	DETAIL SHEET <h1 style="font-size: 2em; margin: 0;">1-D</h1>
---	---	---	---



BuildDeck - 8" Deck with 4" Concrete Cap

Span Length (Ft.)		8	9	10	11	12	13	14	15	16	17	18	19	20	21	22	23	24	
Qty. Rein. Steel Rqtd.	Bar Size Designation	Live Load																	
2	#4	469	357	276	216	171	136	108	86	67	51	39	28	19	10	2	X	X	
2	#5	752	580	441	331	252	194	150	117	90	69	52	38	26	16	8	1	X	
2	#6	998	703	512	383	291	223	174	136	106	82	63	47	34	23	14	7	1	
2	#7	1165	815	590	440	333	257	199	156	122	96	74	57	43	31	22	13	6	
Assumptions:		Concrete Design Yield Strength F _c = 4000 psi																	
		Steel Yield Strength F _y = 60 ksi																	
		Addtl. Applied Dead Ld. Incl. DL = 15 psf																	
		Long Term Deflection Def < L/480																	
		Stirrup Reinforcement in Beam #3 rebar, 4 ft each end @ 5" O.C.																	
		Slab Reinforcement 12" x 12" Grid #4 Steel																	

ALL TABLES PROVIDED FOR ESTIMATION PURPOSES ONLY. ALL DESIGNS MUST BE REVIEWED AND APPROVED BY THE PROJECT SPECIFIC ENGINEER OF RECORD.

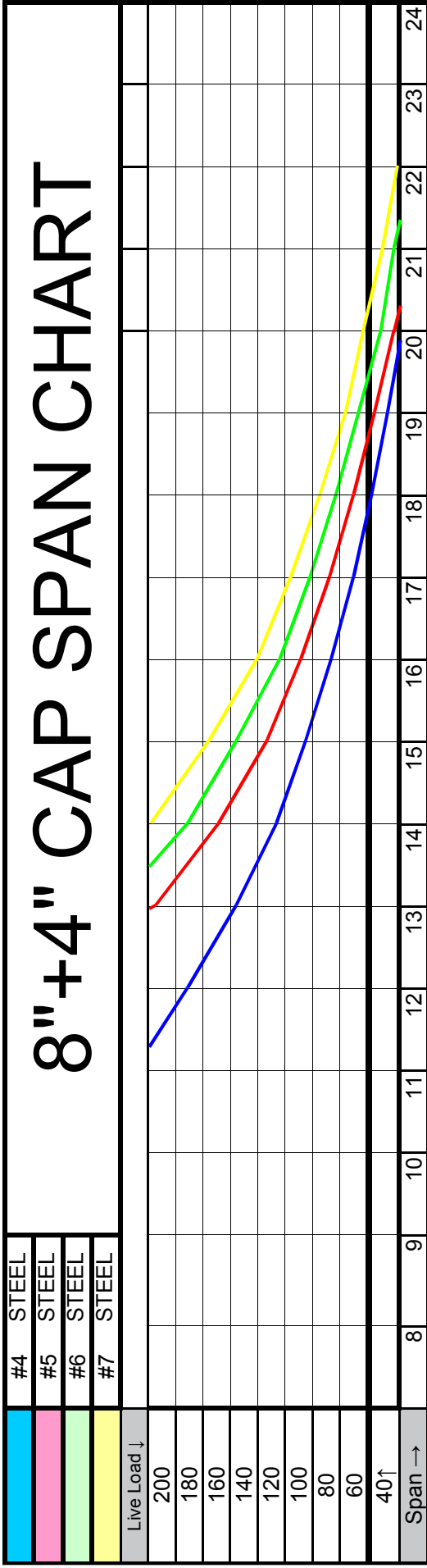
		BUILDDECK 8" +4" CONCRETE CAP TABLE
OFFICE: 405-840-3386 TOLL FREE: 866-222-2575 FAX: 831-597-0792 buildblock.com		DATE/REV: _____ SCALE: _____ NTS: _____
CONSTRUCTION SHALL BE IN ACCORDANCE WITH ALL APPLICABLE LOCAL AND NATIONAL CODES. ALL DRAWINGS ARE SUBJECT TO CHANGE WITHOUT NOTICE.		1-E
		DETAIL SHEET



			OFFICE: 405-840-3386 TOLL FREE: 866-222-2575 FAX: 831-597-0792 buildblock.com		
	CONSTRUCTION SHALL BE IN ACCORDANCE WITH ALL APPLICABLE LOCAL AND NATIONAL CODES. ALL DRAWINGS ARE SUBJECT TO CHANGE WITHOUT NOTICE.				
BUILDDECK 8" +4" CONCRETE CAP CHART		DATE/REV SCALE NTS	NOTES		
		DETAIL SHEET		1-F	



BuildDeck - 10" Deck With 2" Concrete Cap

Span Length (Ft.)		8	9	10	11	12	13	14	15	16	17	18	19	20	21	22	23	24	25	26	27
Qty. Rein. Steel Rqd.	Bar Size Designation																				
2	#4	479	368	288	230	201	149	122	99	77	59	44	32	22	14	7	X	X	X	X	X
2	#5	753	580	424	318	244	188	147	115	89	68	52	39	28	19	11	4	X	X	X	X
2	#6	979	686	499	372	283	217	169	132	104	81	62	47	35	25	16	9	3	X	X	X
2	#7	1151	803	580	431	326	251	195	153	120	94	74	57	44	32	23	15	8	2	X	X



Live Load

Assumptions: Concrete Design Yield Strength Fc = 4000 psi
 Steel Yield Strength FY = 60 ksi
 Addtl. Applied Dead Ld. Incl. DL = 15 psf
 Long Term Deflection Def < L/480
 Stirrup Reinforcement in Beam #3 rebar, 4 ft each end @ 5" O.C.
 Slab Reinforcement 12" x 12" Grid #4 Steel

ALL TABLES PROVIDED FOR ESTIMATION PURPOSES ONLY. ALL DESIGNS MUST BE REVIEWED AND APPROVED BY THE PROJECT SPECIFIC ENGINEER OF RECORD.

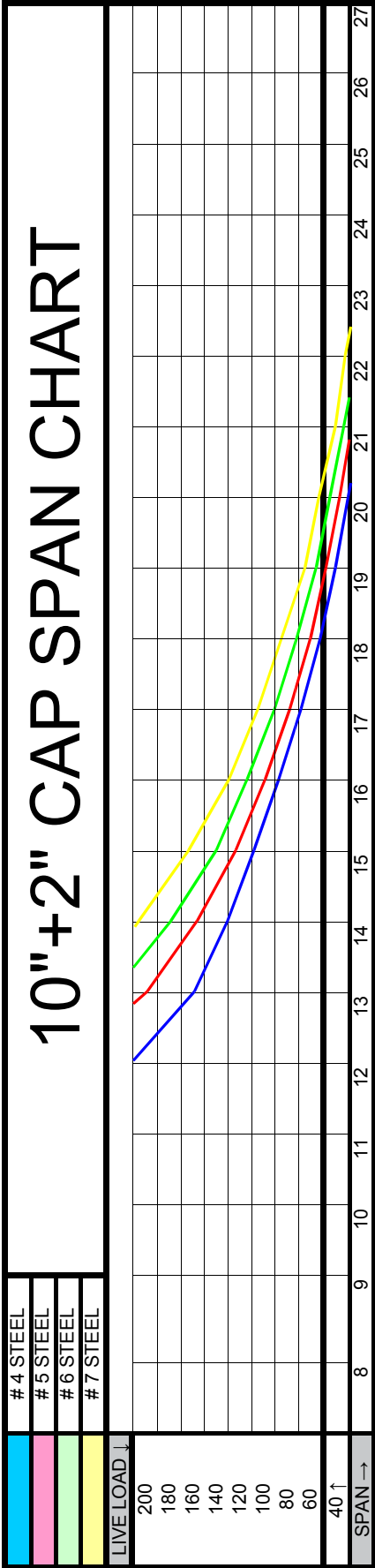
		OFFICE: 405-840-3386 TOLL FREE: 866-222-2575 FAX: 831-597-0792 buildblock.com
BUILDDECK 10" + 2" CONCRETE CAP TABLE		
DATE/REV	SCALE	NTS
NOTES		
CONSTRUCTION SHALL BE IN ACCORDANCE WITH ALL APPLICABLE LOCAL AND NATIONAL CODES. ALL DRAWINGS ARE SUBJECT TO CHANGE WITHOUT NOTICE.		
BUILDDECK 10" + 2" CONCRETE CAP TABLE		DETAIL SHEET <h1 style="font-size: 48pt;">2-A</h1>



		OFFICE: 405-840-3386 TOLL FREE: 866-222-2575 FAX: 831-597-0792 buildblock.com
BUILDDECK 10" +2" CONCRETE CAP CHART		
DATE/REV	SCALE	NTS
NOTES		
CONSTRUCTION SHALL BE IN ACCORDANCE WITH ALL APPLICABLE LOCAL AND NATIONAL CODES. ALL DRAWINGS ARE SUBJECT TO CHANGE WITHOUT NOTICE.		
BUILDDECK 10" +2" CONCRETE CAP CHART		DETAIL SHEET <h1 style="font-size: 2em;">2-B</h1>



BuildDeck - 10" Deck With 3" Concrete Cap

Span Length (Ft.)		8	9	10	11	12	13	14	15	16	17	18	19	20	21	22	23	24	25	26	27	
Qty. Rein. Steel Rqd.	Bar Size Designation																					
2	#4	536	411	321	254	201	165	134	109	87	71	56	43	34	23	14	6	X	X	X	X	
2	#5	850	659	522	412	316	245	192	151	119	94	74	56	42	30	20	13	5	X	X	X	
2	#6	1214	894	650	486	370	286	224	177	140	111	88	69	53	40	29	19	12	5	X	X	
2	#7	1510	1055	763	568	432	334	261	206	164	130	103	82	65	50	38	28	18	11	8	X	

Live Load

Assumptions:
 Concrete Design Yield Strength $F_c = 4000$ psi
 Steel Yield Strength $F_y = 60$ ksi
 Addtl. Applied Dead Ld. Incl. $DL = 15$ psf
 Long Term Deflection $Def < L/480$
 Stirrup Reinforcement in Beam #3 rebar, 4 ft each end @ 5" O.C.
 Slab Reinforcement 12" x 12" Grid #4 Steel

ALL TABLES PROVIDED FOR ESTIMATION PURPOSES ONLY. ALL DESIGNS MUST BE REVIEWED AND APPROVED BY THE PROJECT SPECIFIC ENGINEER OF RECORD.

		BUILDDECK 10" + 3" CONCRETE CAP TABLE DATE/REV: SCALE: NTS NOTES:	DETAIL SHEET <h1 style="font-size: 48pt;">2-C</h1>
CONSTRUCTION SHALL BE IN ACCORDANCE WITH ALL APPLICABLE LOCAL AND NATIONAL CODES. ALL DRAWINGS ARE SUBJECT TO CHANGE WITHOUT NOTICE.			

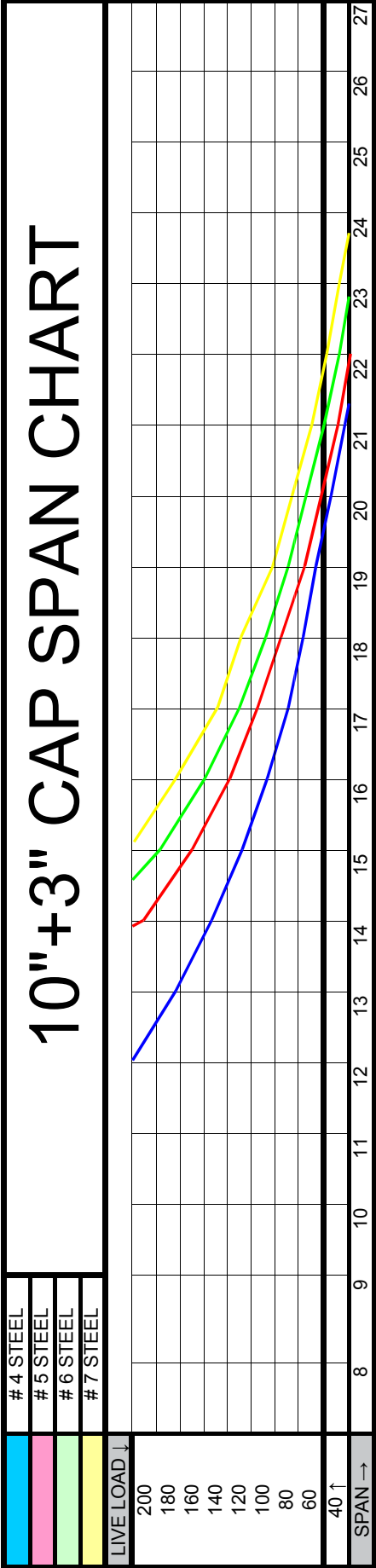

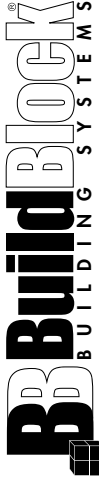
			OFFICE: 405-840-3386 TOLL FREE: 866-222-2575 FAX: 831-597-0792 buildblock.com	
	CONSTRUCTION SHALL BE IN ACCORDANCE WITH ALL APPLICABLE LOCAL AND NATIONAL CODES. ALL DRAWINGS ARE SUBJECT TO CHANGE WITHOUT NOTICE.			
BUILDDECK 10" + 3" CONCRETE CAP CHART			DATE/REV: _____ SCALE: _____ NTS	DETAIL SHEET
NOTES			2-D	

BuildDeck - 10" Deck With 4" Concrete Cap

Span Length (Ft.)		8	9	10	11	12	13	14	15	16	17	18	19	20	21	22	23	24	25	26	27	
Bar Size Designation		Live Load																				
Qty. Rein. Steel Rqd.	#4	592	453	354	279	224	179	145	117	94	75	59	46	34	25	16	9	2	X	X	X	
#5	945	732	579	466	380	313	250	199	159	127	101	79	62	47	35	24	15	7	X	X	X	
#6	1358	1058	830	622	476	371	292	232	185	149	119	95	75	59	45	33	24	15	8	X	X	
#7	1821	1349	979	730	557	433	341	270	216	175	140	113	91	72	57	44	33	23	15	8	8	

Assumptions: Concrete Design Yield Strength $F'_c = 4000$ psi
 Steel Yield Strength $F_y = 60$ ksi
 Addtl. Applied Dead Ld. Incl. DL = 15 psf
 Long Term Deflection Def < L/480
 Stirrup Reinforcement in Beam #3 rebar, 4 ft each end @ 5" O.C.
 Slab Reinforcement 12" x 12" Grid #4 Steel

ALL TABLES PROVIDED FOR ESTIMATION PURPOSES ONLY. ALL DESIGNS MUST BE REVIEWED AND APPROVED BY THE PROJECT SPECIFIC ENGINEER OF RECORD.



BUILDING SYSTEMS

OFFICE: 405-840-3386 | TOLL FREE: 866-222-2575 | FAX: 831-597-0792
 buildblock.com

BUILDDECK 10" + 4" CONCRETE CAP TABLE

DATE/REV	SCALE	NTS	DETAIL SHEET
NOTES			2-E

CONSTRUCTION SHALL BE IN ACCORDANCE WITH ALL APPLICABLE LOCAL AND NATIONAL CODES. ALL DRAWINGS ARE SUBJECT TO CHANGE WITHOUT NOTICE.

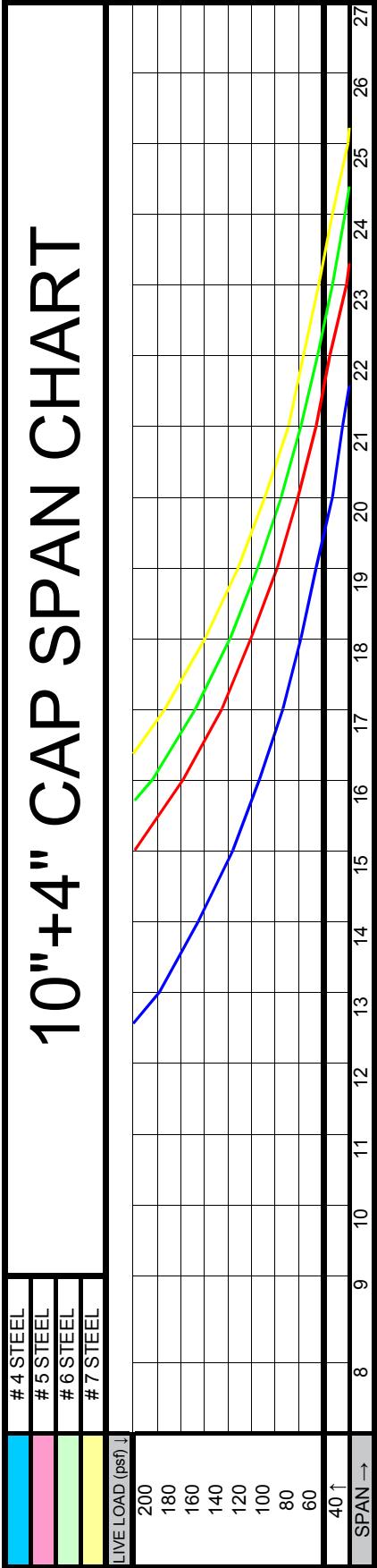



	<h2 style="margin: 0;">BB BuildBlock</h2> <p style="margin: 0; font-weight: normal;">B U I L D I N G S Y S T E M S</p>	<p style="font-size: small;">OFFICE: 405-840-3386 TOLL FREE: 866-222-2575 FAX: 831-597-0792 buildblock.com</p>
<p style="font-weight: bold; margin: 0;">BUILDDECK 10" +4" CONCRETE CAP CHART</p>		
<p style="font-size: x-small;">DATE/REV</p>	<p style="font-size: x-small;">SCALE</p>	<p style="font-size: x-small;">NTS</p>
<p style="font-size: x-small;">NOTES</p>		
<p>CONSTRUCTION SHALL BE IN ACCORDANCE WITH ALL APPLICABLE LOCAL AND NATIONAL CODES. ALL DRAWINGS ARE SUBJECT TO CHANGE WITHOUT NOTICE.</p>		
<p style="font-size: x-small;">DETAIL SHEET</p>		<p>2-F</p>

BuildDeck - 12" Deck With 2" Concrete Cap



Span Length (Ft.)		Live Load																												
		8	9	10	11	12	13	14	15	16	17	18	19	20	21	22	23	24	25	26	27	28	29	30	31					
Qty. Rein.	Bar Size																													
Steel Rqd.	Designation																													
2	#4	464	366	292	237	193	159	131	108	90	74	61	49	40	31	23	16	9	X	X	X	X	X	X	X	X	X			
2	#5	736	585	474	390	316	251	200	161	130	105	83	67	52	40	30	21	13	7	X	X	X	X	X	X	X	X			
2	#6	1342	1049	824	617	473	369	291	232	187	151	121	98	79	62	49	38	28	20	12	6	X	X	X	X	X	X			
2	#7	1780	1344	975	727	554	431	339	270	217	175	142	115	93	74	59	46	36	26	18	11	5	X	X	X	X	X			

Assumptions: Concrete Design Yield Strength $F_c = 4000$ psi
 Steel Yield Strength $F_y = 60$ ksi
 Addtl. Applied Dead Ld. Incl. $DL = 15$ psf
 Long Term Deflection $Def < L/480$
 Stirrup Reinforcement in Beam #3 rebar, 4 ft each end @ 5" O.C.
 Slab Reinforcement 12" x 12" Grid #4 Steel

ALL TABLES PROVIDED FOR ESTIMATION PURPOSES ONLY. ALL DESIGNS MUST BE REVIEWED AND APPROVED BY THE PROJECT SPECIFIC ENGINEER OF RECORD.

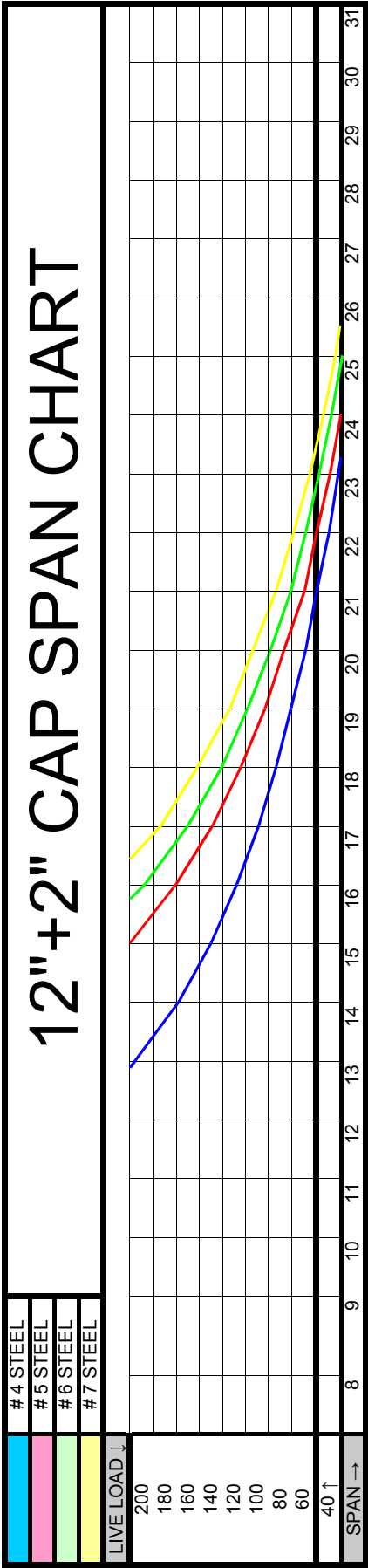
			BUILDDECK 12" +2" CONCRETE CAP TABLE		DETAIL SHEET
	BUILDING SYSTEMS		DATE/REV	SCALE	NTS
OFFICE: 405-840-3386 TOLL FREE: 866-222-2575 FAX: 831-597-0792 buildblock.com		CONSTRUCTION SHALL BE IN ACCORDANCE WITH ALL APPLICABLE LOCAL AND NATIONAL CODES. ALL DRAWINGS ARE SUBJECT TO CHANGE WITHOUT NOTICE.			





Seal			BUILDDECK 12" +2" CONCRETE CAP CHART
	OFFICE: 405-840-3386 TOLL FREE: 866-222-2575 FAX: 831-597-0792 buildblock.com		DATE/REV SCALE NTS
CONSTRUCTION SHALL BE IN ACCORDANCE WITH ALL APPLICABLE LOCAL AND NATIONAL CODES. ALL DRAWINGS ARE SUBJECT TO CHANGE WITHOUT NOTICE.			DETAIL SHEET <h1 style="font-size: 2em; margin: 0;">3-B</h1>

BuildDeck - 12" Deck With 3" Concrete Cap



Span Length (Ft.)	8	9	10	11	12	13	14	15	16	17	18	19	20	21	22	23	24	25	26	27	28	29	30	31	
Qty. Rein. Steel Rqd.	Live Load																								
Bar Size Designation	Live Load																								
#4	659	507	399	318	256	209	171	140	115	94	77	62	50	39	29	22	14	8	X	X	X	X	X	X	X
#5	1043	810	644	521	427	354	296	249	201	163	132	107	86	68	54	41	31	21	13	6	X	X	X	X	X
#6	1492	1165	931	757	587	459	364	291	235	190	155	126	102	82	66	52	40	29	21	13	7	X	X	X	X
#7	1992	1560	1214	907	693	539	427	341	275	223	182	149	121	99	80	64	50	39	30	20	14	7	X	X	X

Assumptions: Concrete Design Yield Strength $F_c = 4000$ psi
 Steel Yield Strength $F_y = 60$ ksi
 Addtl. Applied Dead Ld. Incl. DL = 15 psf
 Long Term Deflection Def < L/480
 Stirrup Reinforcement in Beam #3 rebar, 4 ft each end @ 5" O.C.
 Slab Reinforcement 12" x 12" Grid #4 Steel

ALL TABLES PROVIDED FOR ESTIMATION PURPOSES ONLY. ALL DESIGNS MUST BE REVIEWED AND APPROVED BY THE PROJECT SPECIFIC ENGINEER OF RECORD.

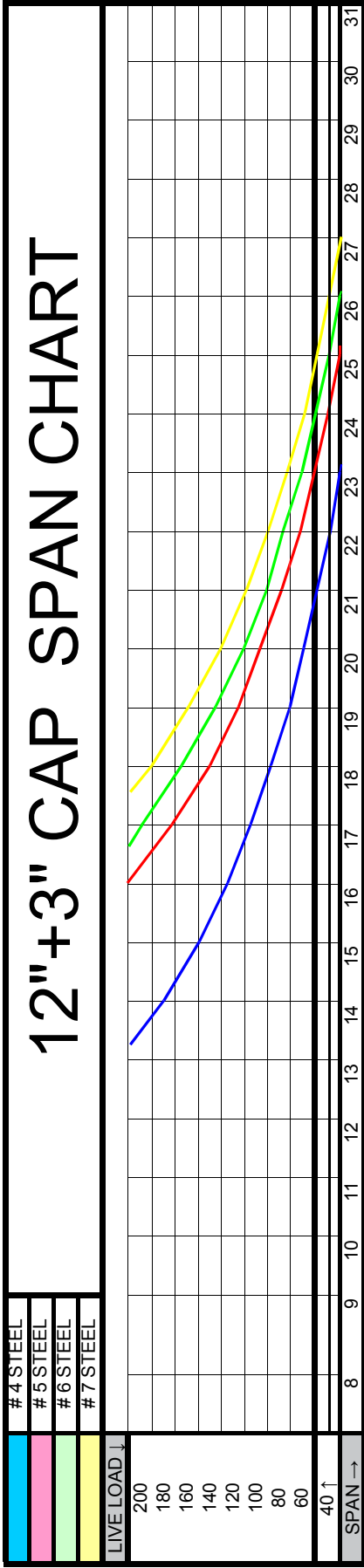
		BUILDECK 12" + 3" CONCRETE CAP TABLE
OFFICE: 405-840-3386 TOLL FREE: 866-222-2575 FAX: 831-597-0792 buildblock.com		DATE/REV: _____ SCALE: _____ NTS: _____
CONSTRUCTION SHALL BE IN ACCORDANCE WITH ALL APPLICABLE LOCAL AND NATIONAL CODES. ALL DRAWINGS ARE SUBJECT TO CHANGE WITHOUT NOTICE.		DETAIL SHEET <h1 style="font-size: 48px; margin: 0;">3-C</h1>





		OFFICE: 405-840-3386 TOLL FREE: 866-222-2575 FAX: 831-597-0792 buildblock.com
BUILDDECK 12" +3" CONCRETE CAP CHART		
DATE/REV	SCALE	NTS
NOTES		
CONSTRUCTION SHALL BE IN ACCORDANCE WITH ALL APPLICABLE LOCAL AND NATIONAL CODES. ALL DRAWINGS ARE SUBJECT TO CHANGE WITHOUT NOTICE.		
DETAIL SHEET		3-D

BuildDeck - 12" Deck With 4" Concrete Cap

Span Length (Ft.)		Live Load																												
		8	9	10	11	12	13	14	15	16	17	18	19	20	21	22	23	24	25	26	27	28	29	30	31					
Qty. Reinf.	Bar Size																													
Steel Rqtd.	Designation																													
2	#4	715	549	431	343	276	224	182	149	121	99	80	63	50	38	28	19	11	5	X	X	X	X	X	X	X				
2	#5	1139	883	701	566	464	384	320	269	227	193	163	134	110	88	71	56	43	32	22	14	7	X	X	X	X				
2	#6	1637	1277	1019	829	684	562	446	358	290	236	193	158	130	106	86	70	55	42	32	22	15	7	X	X	X				
2	#7	2197	1720	1378	1110	850	663	525	421	341	278	228	187	154	127	104	85	68	54	43	32	24	15	8	2					

Assumptions: Concrete Design Yield Strength $F_c = 4000$ psi
 Steel Yield Strength $F_y = 60$ ksi
 Addtl. Applied Dead Ld. Incl. $DL = 15$ psf
 Long Term Deflection $Def < L/480$
 Stirrup Reinforcement in Beam #3 rebar, 4 ft each end @ 5" O.C.
 Slab Reinforcement 12" x 12" Grid #4 Steel

ALL TABLES PROVIDED FOR ESTIMATION PURPOSES ONLY. ALL DESIGNS MUST BE REVIEWED AND APPROVED BY THE PROJECT SPECIFIC ENGINEER OF RECORD.

		BUILDDECK 12" + 4" CONCRETE CAP TABLE DATE/REV: SCALE: NTS NOTES:	DETAIL SHEET <h1 style="font-size: 48px; margin: 0;">3-E</h1>
OFFICE: 405-840-3386 TOLL FREE: 866-222-2575 FAX: 831-597-0792 buildblock.com			
CONSTRUCTION SHALL BE IN ACCORDANCE WITH ALL APPLICABLE LOCAL AND NATIONAL CODES. ALL DRAWINGS ARE SUBJECT TO CHANGE WITHOUT NOTICE.			

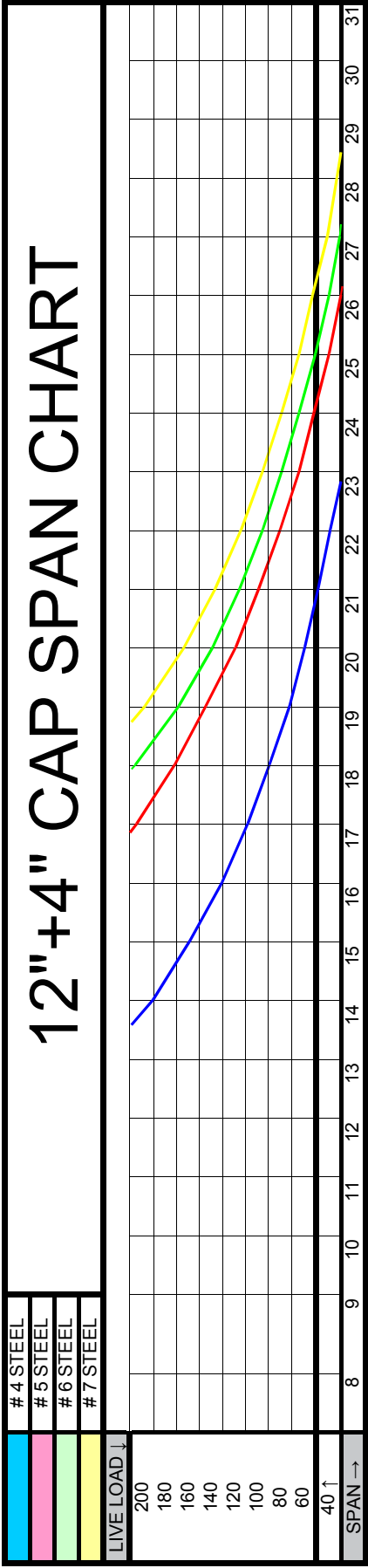

BUILDDECK 12" + 4" CONCRETE CAP CHART		DETAIL SHEET
DATE/REV	SCALE	NTS
NOTES		
CONSTRUCTION SHALL BE IN ACCORDANCE WITH ALL APPLICABLE LOCAL AND NATIONAL CODES. ALL DRAWINGS ARE SUBJECT TO CHANGE WITHOUT NOTICE.		
BB BuildBlock BUILDING SYSTEMS		<h1 style="font-size: 48px; margin: 0;">3-F</h1>
OFFICE: 405-840-3386 TOLL FREE: 866-222-2575 FAX: 831-597-0792 buildblock.com		



BuildDeck - 12" Deck (+ 2" EPS Riser) With 2" Concrete Cap

Span Length (Ft.)		Live Load																																			
		8	9	10	11	12	13	14	15	16	17	18	19	20	21	22	23	24	25	26	27	28	29	30	31	32	33	34	35	36							
City. Reinf.	2	726	561	442	355	288	237	196	163	136	114	95	79	65	52	43	34	26	19	13	7	X	X	X	X	X	X	X	X	X	X	X	X	X	X	X	
Steel Rqd.	#4	1140	888	708	574	473	394	332	280	240	205	169	140	115	94	77	62	49	39	29	21	14	7	X	X	X	X	X	X	X	X	X	X	X	X	X	
	#5	1622	1268	1015	828	687	560	446	359	292	239	197	162	133	110	90	74	60	48	37	28	19	13	7	X	X	X	X	X	X	X	X	X	X	X		
	#6	2156	1691	1358	1108	848	661	524	421	341	278	229	189	156	129	107	88	72	58	46	36	27	20	12	6	X	X	X	X	X	X	X	X	X	X		
	#7																																				

Assumptions: Concrete Design Yield Strength
 Steel Yield Strength
 Addit. Applied Dead Ld. Incl.
 Long Term Deflection
 Stirrup Reinforcement in Beam
 Slab Reinforcement

F'c = 4000 psi
 Fy = 60 ksi
 DL = 15 psf
 Def < L/480
 #3 rebar, 4 ft each end @ 5" O.C.
 12" x 12" Grid #4 Steel

ALL TABLES PROVIDED FOR ESTIMATION PURPOSES ONLY. ALL DESIGNS MUST BE REVIEWED AND APPROVED BY THE PROJECT SPECIFIC ENGINEER OF RECORD.



BB BuildBlock
B U I L D I N G S Y S T E M S



OFFICE: 405-840-3386 | TOLL FREE: 866-222-2575 | FAX: 831-597-0792
 buildblock.com

BUILDDECK 12+2 TOP HAT +2" CONCRETE TABLE

DATE/REV	SCALE	NTS	DETAIL SHEET
NOTES			4-A

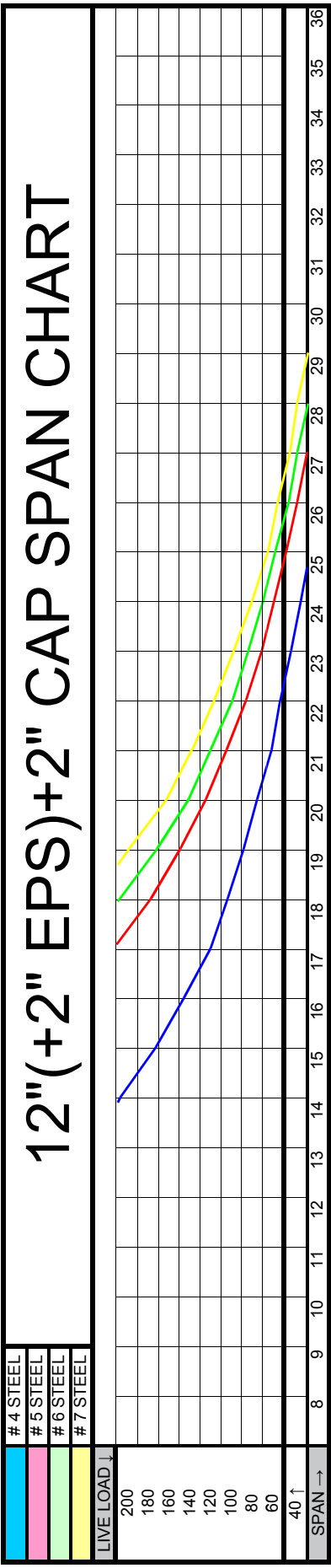
CONSTRUCTION SHALL BE IN ACCORDANCE WITH ALL APPLICABLE LOCAL AND NATIONAL CODES. ALL DRAWINGS ARE SUBJECT TO CHANGE WITHOUT NOTICE.



	 <p>OFFICE: 405-840-3386 TOLL FREE: 866-222-2575 FAX: 831-597-0792 buildblock.com</p>	<p>BUILDBLOCK</p> <p>CONSTRUCTION SHALL BE IN ACCORDANCE WITH ALL APPLICABLE LOCAL AND NATIONAL CODES. ALL DRAWINGS ARE SUBJECT TO CHANGE WITHOUT NOTICE.</p>
<p>BUILDBLOCK 12" + 2 TOP HAT + 2" CONCRETE CAP CHART</p>		
DATE/REV	SCALE	NTS
NOTES		
<p>DETAIL SHEET</p> <h1 style="font-size: 48px; margin: 0;">4-B</h1>		

BuildDeck - 12" Deck (+ 2" EPS Riser) With 3" Concrete Cap

Span Length (Ft.)		8	9	10	11	12	13	14	15	16	17	18	19	20	21	22	23	24	25	26	27	28	29	30	31	32	33	34	35	36					
Qty. Rein. Steel Rqd.		Live Load																																	
Bar Size Designation	#4	783	603	476	381	308	252	208	172	142	118	97	80	65	53	41	32	24	16	10	4	X	X	X	X	X	X	X	X	X	X	X	X	X	X
#5	#6	1237	963	767	621	510	425	356	301	256	218	187	161	138	116	96	78	63	50	39	29	21	13	6	X	X	X	X	X	X	X	X	X	X	X
#7																																			
Concrete Design Yield Strength																																			
Steel Yield Strength																																			
Addtl. Applied Dead Ld. Incl.																																			
Long Term Deflection																																			
Stirrup Reinforcement in Beam																																			
Slab Reinforcement																																			

ALL TABLES PROVIDED FOR ESTIMATION PURPOSES ONLY. ALL DESIGNS MUST BE REVIEWED AND APPROVED BY THE PROJECT SPECIFIC ENGINEER OF RECORD.





OFFICE: 405-840-3386 | TOLL FREE: 866-222-2575 | FAX: 831-597-0792
 buildblock.com

BUILDDECK 12" +2" EPS TOP HAT +3" CONCRETE CAP TABLE

DATE/REV	SCALE	NTS	DETAIL SHEET
			4-C
NOTES			
CONSTRUCTION SHALL BE IN ACCORDANCE WITH ALL APPLICABLE LOCAL AND NATIONAL CODES. ALL DRAWINGS ARE SUBJECT TO CHANGE WITHOUT NOTICE.			

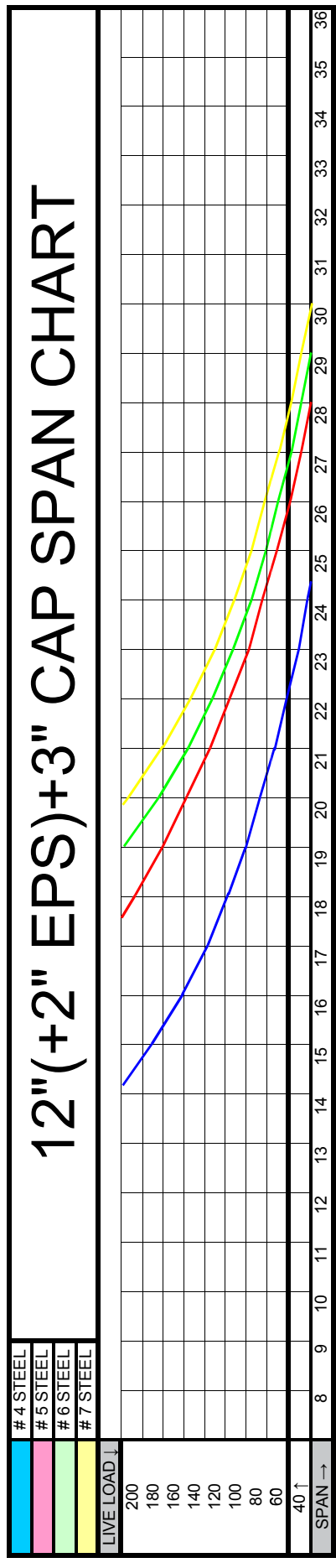

12"(+2" EPS)+3" CAP SPAN CHART



	 <p>OFFICE: 405-840-3386 TOLL FREE: 866-222-2575 FAX: 831-597-0792 buildblock.com</p>	<p>BUILDDECK 12" +2" EPS TOP HAT +3" CONCRETE CAP CHART</p> <p>DATE/REV: SCALE: NTS</p> <p>NOTES</p> <p>CONSTRUCTION SHALL BE IN ACCORDANCE WITH ALL APPLICABLE LOCAL AND NATIONAL CODES. ALL DRAWINGS ARE SUBJECT TO CHANGE WITHOUT NOTICE.</p>	<p>DETAIL SHEET</p> <h1 style="font-size: 48px; margin: 0;">4-D</h1>
---	--	---	--

BuildDeck - 12" Deck (+ 2" EPS Riser) With 4" Concrete Cap

Span Length (Ft.)	8	9	10	11	12	13	14	15	16	17	18	19	20	21	22	23	24	25	26	27	28	29	30	31	32	33	34	35	36			
Qty. Rein. Steel Rqd.	839	646	508	406	328	268	219	180	149	123	100	82	66	52	41	30	21	13	6	X	X	X	X	X	X	X	X	X	X	X		
Bar Size Designation	#4	#4	#4	#4	#4	#4	#4	#4	#4	#4	#4	#4	#4	#4	#4	#4	#4	#4	#4	#4	#4	#4	#4	#4	#4	#4	#4	#4	#4	#4		
Concrete Design Yield Strength $F_c = 4000$ ps	1334	1037	824	666	547	454	381	321	272	232	198	170	145	124	105	89	75	63	50	38	29	20	12	5	X	X	X	X	X			
Steel Yield Strength	1916	1497	1197	975	806	674	571	487	418	346	286	238	198	165	138	114	94	77	63	50	39	30	21	13	6	X	X	X	X			
Addtl. Applied Dead Ld. Incl. DL = 15 psf	2576	2018	1619	1324	1099	925	754	608	495	407	336	280	233	196	164	137	115	95	79	64	52	41	31	23	15	8	X	X	X			
Long Term Deflection	Concrete Design Yield Strength $F_c = 4000$ ps																															
Stirrup Reinforcement in Beas #3 rebar, 4 ft each end @ 5" O.C.	Steel Yield Strength																															
Slab Reinforcement	Addtl. Applied Dead Ld. Incl. DL = 15 psf																															
	Long Term Deflection																															
	Stirrup Reinforcement in Beas #3 rebar, 4 ft each end @ 5" O.C.																															
	Slab Reinforcement																															
	12" x 12" Grid #4 Steel																															
	Live Load																															
	ALL TABLES PROVIDED FOR ESTIMATION PURPOSES ONLY. ALL DESIGNS MUST BE REVIEWED AND APPROVED BY THE PROJECT SPECIFIC ENGINEER OF RECORD.																															

		BUILDDECK 12" +2" EPS TOP HAT +4" CONCRETE CAP TABLE DATE/REV: SCALE: NTS: NOTES: CONSTRUCTION SHALL BE IN ACCORDANCE WITH ALL APPLICABLE LOCAL AND NATIONAL CODES. ALL DRAWINGS ARE SUBJECT TO CHANGE WITHOUT NOTICE.
		DETAIL SHEET <h1 style="font-size: 4em; margin: 0;">4-E</h1>

12"(+2" EPS)+4" CAP SPAN CHART

4 STEEL
5 STEEL
6 STEEL
7 STEEL

LIVE LOAD ↓

200
180
160
140
120
100
80
60

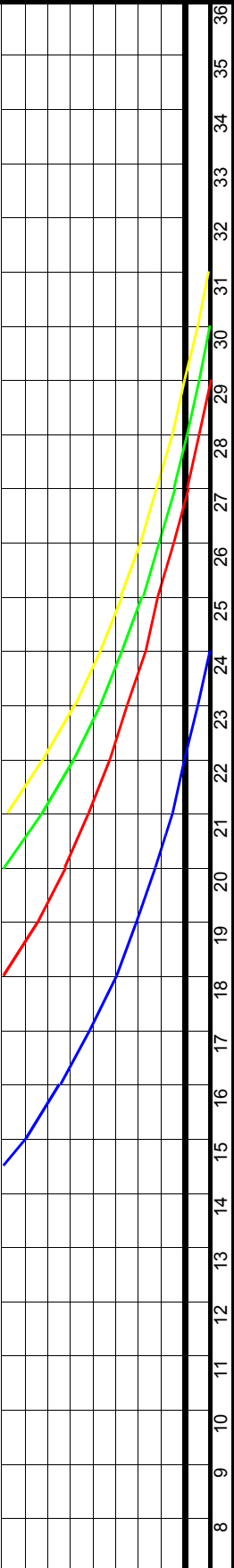

SPAN →

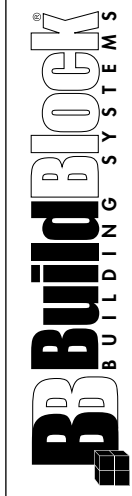

OFFICE: 405-840-3386 | TOLL FREE: 866-222-2575 | FAX: 831-597-0792
 buildblock.com

BUILDDECK 12" +2" EPS TOP HAT +4" CONCRETE CAP CHART

DATE/REV	SCALE	NTS	DETAIL SHEET
NOTES			4-F
CONSTRUCTION SHALL BE IN ACCORDANCE WITH ALL APPLICABLE LOCAL AND NATIONAL CODES. ALL DRAWINGS ARE SUBJECT TO CHANGE WITHOUT NOTICE.			

BuildDeck - 12" Deck (+ 4" EPS Riser) with 4" Concrete Cap														
Span Length	27	28	29	30	31	32	33	34	35	36	37	38	39	40
Bottom Reinf. Requirements	130	115	100	90	65	40	X	X	X	X	X	X	X	X
(2) # 6	Allowable Live Load (psf)													
	Required Camber (in)													
	0	0.5	0.5	0.5	1	1	N/A	N/A	N/A	N/A	N/A	N/A	N/A	N/A
(2) # 7	Stirrup End Distance (ft)													
	7	7	7	7	6	4	N/A	N/A	N/A	N/A	N/A	N/A	N/A	N/A
	195	175	160	145	125	90	55	30	x	x	x	x	x	x
(2) # 8	Required Camber (in)													
	0	0.5	0.5	0.5	0.5	1	1	1	x	x	x	x	x	x
	8.5	8.5	9	9	9	8	6	3.5	N/A	N/A	N/A	N/A	N/A	N/A
(2) # 8	Stirrup End Distance (ft)													
	265	240	215	195	180	155	115	80	50	25	X	X	X	X
	0	0.5	0.5	0.5	0.5	0.5	1	1	1	1	N/A	N/A	N/A	N/A
9.5	10	10	10	10	10.5	10	9.5	8.5	6.5	1	N/A	N/A	N/A	N/A

ASSUMPTIONS:

f_c = 4,000 psi
 F_y = 60 ksi
 DL = 15 psf

ADDITIONAL NOTES:

- 1.) Long term deflection kept less than L/480
- 2.) Required Stirrups: #3 @ 9" O.C. Distances Shown in Table.
- 3.) Required Slab Reinforcement #5 @ 12" O.C. Parallel to BuildDeck Span, #3 @ 12" O.C. Perpendicular to BuildDeck Span
- 4.) Required Lap Splice Lengths #6 = 38", #7 = 54", #8 = 62"

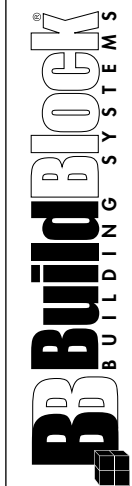
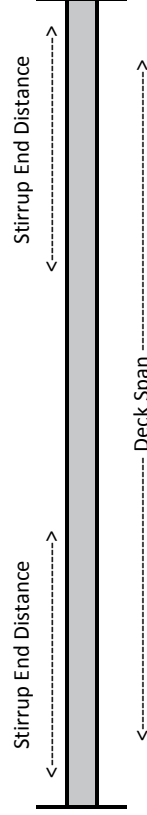

OFFICE: 405-840-3386 | TOLL FREE: 866-222-2575 | FAX: 831-597-0792
 buildblock.com

BUILDDECK 12" +4" EPS TOP HAT +4" CONCRETE CAP TABLE

DATE/REV	SCALE	NTS	DETAIL SHEET
----------	-------	-----	--------------

NOTES

CONSTRUCTION SHALL BE IN ACCORDANCE WITH ALL APPLICABLE LOCAL AND NATIONAL CODES. ALL DRAWINGS ARE SUBJECT TO CHANGE WITHOUT NOTICE.

5-A

BuildDeck - 12" Deck (+ 6" EPS Riser) with 4" Concrete Cap														
Span Length	27	28	29	30	31	32	33	34	35	36	37	38	39	40
Bottom Reinf. Requirements	155	135	120	110	95	85	75	55	30	X	X	X	X	X
(2) # 6	Allowable Live Load (psf)													
	0	0	0	0.5	0.5	0.5	1	1	1	N/A	N/A	N/A	N/A	N/A
(2) # 7	Required Camber (in)													
	7	7	7	7	7	7	6.5	5.5	3	N/A	N/A	N/A	N/A	N/A
(2) # 8	Stirrup End Distance (ft)													
	240	215	195	175	160	145	130	110	75	45	20	x	x	x
(2) # 6	Required Camber (in)													
	0	0	0	0.5	0.5	0.5	1	1	1	1	1	N/A	N/A	N/A
(2) # 7	Stirrup End Distance (ft)													
	9	9	9	9	9	9.5	9.5	9	7.5	5.5	1	N/A	N/A	N/A
(2) # 8	Required Camber (in)													
	335	305	275	245	225	205	190	175	140	100	70	40	x	x
(2) # 6	Stirrup End Distance (ft)													
	0	0	0	0.5	0.5	0.5	0.5	0.5	1	1	1	1	N/A	N/A
(2) # 7	Stirrup End Distance (ft)													
	10	10	10.5	10.5	10.5	11	11	11	10.5	9.5	8.5	6	N/A	N/A

ASSUMPTIONS:

$f'_c = 4,000$ psi

$F_y = 60$ ksi

DL = 15 psf

ADDITIONAL NOTES:

- 1.) Long term deflection kept less than L/480
- 2.) Required Stirrups: #3 @ 9" O.C. Distances Shown in Table.
- 3.) Required Slab Reinforcement #5 @ 12" O.C. Parallel to BuildDeck Span, #3 @ 12" O.C. Perpendicular to BuildDeck Span
- 4.) Required Lap Splice Lengths #6 = 38", #7 = 54", #8 = 62"

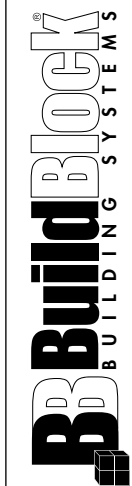
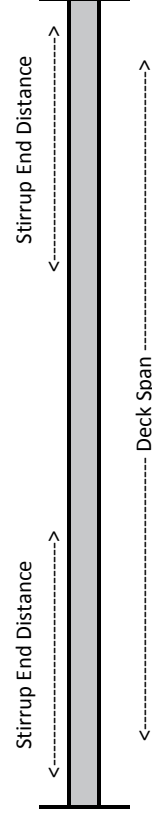

OFFICE: 405-840-3386 | TOLL FREE: 866-222-2575 | FAX: 831-597-0792
 buildblock.com

BUILDDECK 12" +6" EPS TOP HAT +4" CONCRETE CAP TABLE

DATE/REV	SCALE	NTS	DETAIL SHEET
NOTES			6-A
CONSTRUCTION SHALL BE IN ACCORDANCE WITH ALL APPLICABLE LOCAL AND NATIONAL CODES. ALL DRAWINGS ARE SUBJECT TO CHANGE WITHOUT NOTICE.			

BuildDeck - 12" Deck (+ 8" EPS Riser) with 4" Concrete Cap

Span Length	27	28	29	30	31	32	33	34	35	36	37	38	39	40
Bottom Reinf. Requirements	175	155	140	125	110	100	90	80	70	60	40	X	X	X
(2) # 6	Allowable Live Load (psf)													
	Required Camber (in)													
	0	0	0	0	0	0	0.5	0.5	1	1	1	N/A	N/A	N/A
(2) # 7	Stirrup End Distance (ft)													
	7	7	7	7	7	7	7	6.5	6.5	6.5	5	N/A	N/A	N/A
	270	245	220	200	185	165	150	135	125	115	90	60	30	x
(2) # 8	Required Camber (in)													
	0	0	0	0	0	0.5	0.5	0.5	0.5	1	1	1	1	N/A
	9	9	9	9	9.5	9.5	9.5	9.5	9.5	9.5	9	7	4	N/A
	380	350	320	290	265	245	225	205	190	175	155	120	85	65
	Required Camber (in)													
	0	0	0	0	0	0.5	0.5	0.5	0.5	1	1	1	1	1
	Stirrup End Distance (ft)													
	10	10	10.5	10.5	10.5	11	11	11	11.5	11.5	11.5	10.5	9.5	8.5

ASSUMPTIONS:

$f_c = 4,000$ psi

$F_y = 60$ ksi

$DL = 15$ psf

ADDITIONAL NOTES:

- 1.) Long term deflection kept less than $L/480$
- 2.) Required Stirrups: #3 @ 9" O.C. Distances Shown in Table.
- 3.) Required Slab Reinforcement #5 @ 12" O.C. Parallel to BuildDeck Span, #3 @ 12" O.C. Perpendicular to BuildDeck Span
- 4.) Required Lap Splice Lengths #6 = 38", #7 = 54", #8 = 62"

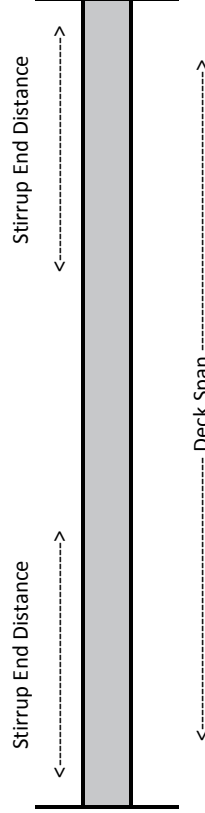

BUILDING SYSTEMS

OFFICE: 405-840-3386 | TOLL FREE: 866-222-2575 | FAX: 831-597-0792
 buildblock.com

BUILDDECK 12" + 8" EPS TOP HAT + 4" CONCRETE CAP TABLE

DATE/REV	SCALE	NTS	DETAIL SHEET
NOTES			7-A

CONSTRUCTION SHALL BE IN ACCORDANCE WITH ALL APPLICABLE LOCAL AND NATIONAL CODES. ALL DRAWINGS ARE SUBJECT TO CHANGE WITHOUT NOTICE.



NORTH AMERICAN MANUFACTURING FACILITIES

BuildBlock Building Systems has fourteen manufacturing facilities across North America and plans to add locations for the next several years. This means we have the manufacturing capacity to meet your ICF needs now and in the future. Shorter shipping distances mean lower freight costs for you and your customers.

BuildBlock continually develops new products and technologies solving problems and meeting needs in residential, commercial, industrial, and institutional construction. We innovate with the goal of creating cost-effective techniques and products for our customers.

BuildBlock partners have facilities around the world to meet your needs including the Philippines, Cyprus, and Egypt and continue to expand. Choosing BuildBlock isn't just about choosing the best ICF block on the market, it's about finding a partner with a strong commitment to our customers, our business partners, and our industry.

MISSION

To harmoniously use the extraordinary gifts and talents of our distributors and dealers to fulfill the goals and dreams of millions of people who want to build better structures as reflected by our motto: "Build it once. Build it for life."

To manufacture one of the most affordable and highest quality Insulating Concrete Forms available in the world today.

To build greatness by providing the resources and services needed for building successful ICF businesses and sustainable ICF structures.

To build an enduring, profitable company while conducting business with Godly character, fairness and integrity.

VISION

We envision a world where BuildBlock ICF technology delivers energy-efficient, safe, healthy, comfortable and sustainable ICF homes and buildings to millions of people worldwide through the uncompromising integrity of BuildBlock's team of distributors, dealers and customers.

VALUES

INTEGRITY – We strive to balance the best interests of our distributors, dealers, customers, employees, and investors in an environment of Godly character and honesty.

EDUCATION – We seek to educate the public on the valuable benefits of ICF structures while recognizing that in order to expand the industry, we must educate installers, architects, and engineers in ICF best practices.

CUSTOMER SATISFACTION – We commit to building a team of employees that is inspired, empowered, and driven to meet the ever-changing needs of our distributors, dealers, and customers while we seek to distinguish ourselves in the marketplace by delivering exceptional customer satisfaction.

INNOVATION – We value and invest heavily in innovation while continually expanding our product line through the development of technologically advanced products.

QUALITY – We commit to producing the finest quality products. We stand by the belief that our brand embodies quality, consistency, user satisfaction, and service.

PROFITABILITY – We commit to the strong work ethic and financial prudence necessary to deliver financial results for our business partners and investors and to ensure a long-term profitable relationship.

EMPOWERMENT – We dedicate ourselves to empowering people to improve and enrich their lives and the world around them.

CONTACT BUILDBLOCK

- ☎
866-222-2575 Toll free
🌐
buildblock.com
- ☎
405-840-3386 Office
🛒
store.buildblock.com
- ☎
831-597-0792 Fax
🎓
training.buildblock.com

SOCIAL MEDIA



The day for building your walls will come, the day for extending your boundaries.

Micah 7:11

